

# ALTERNATIVE FUTURES FOR CORROSION AND DEGRADATION RESEARCH

*Impact of Atomic Effects Corrosion  
on Material Sustainment*

**Dr. Charles Mueller**

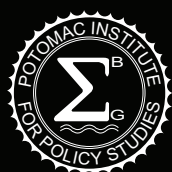

POTOMAC INSTITUTE PRESS

Copyright © 2015, Potomac Institute Press, All rights reserved.  
Published by Potomac Institute Press  
Potomac Institute for Policy Studies

ISBN: 978-0-9963960-1-1 Paperback

Cover images (front, back, title page, page 28): by Alex Taliesen, © 2015. Artist's conception of a gamma ray collision in a semiconductor lattice.

This book contains information obtained from multiple sources, including interviews. The author and publisher gratefully acknowledge the permission granted to reproduce copyrighted material in this book and have made every effort to trace copyright holders and to obtain their permission for use of this material. The author and publisher apologize for any omissions and would be grateful if notified of any corrections that should be incorporated in future reprints or editions of this book. Government-produced materials are not copyright protected (17 U.S.C. § 105). The author and publisher do not hold the copyright to works of the United States government appearing in this publication. The author and publisher do not hold the copyright to works licensed through Creative Commons appearing in this publication. The author and publisher cannot assume responsibility for the validity of all materials or the consequences of their use; the view and opinions expressed do not necessarily reflect those of the Institute and publisher.

This is a product of the Potomac Institute for Policy Studies. **The conclusions of this study are our own and do not necessarily represent the views of the sponsors or participants.**

Note: All images included abbreviated citations in text – full attributions are provided for all images and can be found under Image Credits, page 171. All hyperlinks current as of November, 2015.

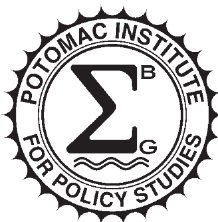

POTOMAC INSTITUTE FOR POLICY STUDIES  
901 N. Stuart St, Suite 1200  
Arlington, VA, 22203  
[www.potomacinstitute.org](http://www.potomacinstitute.org)  
Telephone: 703.525.0770; Fax: 703.525.0299  
Email: [webmaster@potomacinstitute.org](mailto:webmaster@potomacinstitute.org)

# ALTERNATIVE FUTURES FOR CORROSION AND DEGRADATION RESEARCH

*Impact of Atomic Effects Corrosion  
on Material Sustainment*



# CONTENTS

FOREWORD .....	VII
PREFACE .....	IX
ACKNOWLEDGEMENTS .....	XII
CHAPTER 1: INTRODUCTION .....	13
Previous Research .....	14
The Discipline of Material Sustainment .....	16
The Current Definition of Corrosion – and Why it is Inadequate .....	22
Organization of the Book .....	26
CHAPTER 2: THE SCIENCE OF MATERIALS DEGRADATION .....	29
Introduction – the Corrosion Spectrum .....	29
The Science Of Matter .....	31
Atoms	
Ions	
Molecules	
The Science Of Degradation .....	41
Low-Energy Collisions	
High-Energy Collisions	
Field Forces	
Spontaneous Degradation	
Degradation Mechanisms: Summary	
Atomic Effects Corrosion Implications .....	44
The Increasing Importance of AEC .....	45
Current Research in AEC Fields .....	48
Nuclear Weapons .....	48
Nuclear Power Facilities .....	50
Nuclear Waste Disposal .....	52
Outer Space .....	54
AEC in Microelectronics .....	56
Single Event Effects	
Other Microelectronics Atomic-Level Degradations	
Microelectronics in Quantum Domains	
Summary .....	62
CHAPTER 3: RECOMMENDATIONS .....	63
DoD Interests and CPO Mission .....	64
Strategy and Policy .....	66
Objective 1: Develop Comprehensive, Full Spectrum Corrosion Policy	
Objective 2: Develop a Broader Coordinated Research Program	
Objective 3: Enact Specific Policy Changes Based on Research Results	
Research .....	76
Examples: Build for Reliability	
Examples: Identify Thresholds	
Summary: Corrosion at the Atomic Scale Represents One Area on a Spectrum of Corrosion Effects that Spans from the Nanoscale to Macroscale .....	83

APPENDIX 1 .....	87
Science of Materials .....	87
The Scientific Principles of AEC .....	87
Thermodynamics of Materials .....	90
Properties of Materials .....	93
<i>Mechanical Properties</i>	
<i>Electrical Properties</i>	
<i>Thermal Properties</i>	
<i>Magnetic Properties</i>	
<i>Optical Properties</i>	
Metals .....	104
<i>Basics of Metals</i>	
<i>Structures</i>	
<i>Specific Metals and Their Properties</i>	
<i>Ferrous Alloy Steels</i>	
Ceramics .....	112
<i>Basics of Ceramics</i>	
<i>Structures</i>	
<i>Ceramics Properties</i>	
<i>Traditional Ceramics</i>	
<i>Advanced Ceramics</i>	
Polymers .....	129
<i>Basics of Polymers</i>	
<i>Polymer Structures</i>	
<i>Polymer Properties</i>	
<i>Plastics and Other Polymers</i>	
<i>Advanced Polymers</i>	
Composites .....	138
APPENDIX 2 .....	139
Direct AEC Damage: Loss of Capability in Microelectronic Material Properties .....	140
<i>History of Microelectronics in Military use</i>	
<i>Microelectronics Basics</i>	
<i>Degradation of Microelectroincs By AEC</i>	
<i>Single Event Effects in Microelectronics</i>	
<i>AEC Catalyzed Electromigration in Microelectronics</i>	
<i>Planning the Future for AEC in Microelectroincs</i>	
Indirect AEC Damage: Loss of Capability in Nuclear Reactor Material	
Properties on Navy Submarines Through Lattice Defects .....	158
<i>History of Nuclear Reactors in Military</i>	
<i>Pressurized Water Reactors</i>	
<i>AEC Mechanisms in Nuclear Reactors</i>	
<i>The Future of AEC in Nuclear Reactors</i>	
GLOSSARY OF ACRONYMS.....	169
IMAGE CREDITS .....	171

# FOREWORD

The Department of Defense (DoD) Corrosion Policy Office (CPO) was established within the Office of the Secretary of Defense in 2003 to combat systematic corrosion and degradation of materials. Corrosion wreaks havoc on military equipment and the infrastructure with which we prepare for and conduct military operations. Part of the CPO's long-term strategy, mandated by law, includes the establishment of a coordinated research and development program for the prevention and mitigation of corrosion for both equipment and infrastructure.

Many research efforts in the corrosion prevention enterprise have been and remain focused on specific, individual mechanisms of corrosion. These efforts have, traditionally, focused on degradation from the chemical environment, and chemical reactions at the molecular level. Much good science has been developed, and that science has resulted in many new corrosion prevention and mitigation methods and applications. With the breadth of technological discovery expanding, however, we are certain that mechanisms beyond chemical reactions are causing materials to degrade. As a result, we have become convinced that a broader research agenda is needed to address materials degradation effects in new areas, such as atomic effects and biological (including macromolecular and microbiological) effects corrosion.

In addition to the broader agenda, we believe a more coordinated, cross-boundary, multidisciplinary approach is required to discover the underlying mechanisms of degradation effects such as "tin whiskers" on microelectronics in which lead-free solder is used. Furthermore, in order to coordinate this broader research agenda, we believe there are accompanying policy and strategy initiatives that need to be implemented.

The material in this book makes the case for a broader definition of corrosion to encompass all mechanisms of materials degradation due to environmental effects, be they chemically induced, atomic or through other biological mechanisms. We need to understand these mechanisms, address their effects and mitigation, and develop better methods for preventing, detecting, predicting, and managing degradation. In addition, this book explores atomic effects corrosion in detail, and recommends initiatives to strengthen our nation's defenses against emerging mechanisms of materials degradation. I look forward to continuing to work on innovative material sustainment based on the rigorous science and analysis in: *Impact of Atomic Effects Corrosion on Material Sustainment*.

**Daniel J. Dunmire**

*Office of Corrosion Policy and Oversight (CPO)*

*Office of the Secretary of Defense (OSD)*

*Washington, DC*





# PREFACE

The purpose of this book is two-fold:

- First, to argue for a broader definition of corrosion rather than the traditional definition that is limited to chemical reactions, only. Specifically, we call for expansion of the definition to include materials degradation and an approach to combatting degradation that we call **material sustainment**.
- Second, to describe one of the elements of that broader definition: specifically, that of degradation at the atomic level, which we call **atomic effects corrosion (AEC)**.

Since before recorded history, mankind has been concerned about materials degradation. In prehistoric times, people's concern was with degradation of simple tools fashioned from materials found in nature; for example, a wooden club could degrade very quickly through biological mechanisms such as rot. As society advanced, the search for "things that last" – and consequently material sustainment – took on different dimensions. The Iron Age, for example, introduced a new dilemma: tools and weapons made of iron were much stronger than those made of bronze, but iron objects were also more prone to rust (corrosion). As a result, during the Iron Age people had to consider trade-offs: do I use a stronger, iron tool that degrades more quickly or keep the weaker, but less likely to corrode, bronze tool? It is not hard to imagine how that choice was made, rather dramatically, after the first fight between swordsmen with iron and bronze weapons. However, with the change to stronger iron weapons and other tools, the issue of chemical corrosion became a much more important consideration.

As mankind advanced through the ages, the ability to address material degradation improved as scientific knowledge of the associated mechanisms increased, and engineers developed counters such as coatings to reduce the impact of corrosive effects. With the dawn of atomic weapons and power, and human exploration of space, we discovered new mechanisms of materials degradation beyond chemical reactions at the molecular level. But the nature of atomic effects associated with nuclear weapons, power and waste products were often highly classified, and to a large degree kept separate from the mainstream of corrosion science. Now that we have entered the Information Age, we are seeing atomic effects in other areas, such as microelectronics, that cannot be explained by the classic, chemical definition of corrosion. Some of these effects, such as "tin whiskers" (which occur in applications in which lead-free solder is used), for example, have not been explained – other than "it's not chemical or electrochemical." In addition, unexplained effects in microbiological environments are emerging; we call these "biological effects corrosion" and introduce them briefly in this volume. Ultimately, to effectively fight corrosion in all its forms, we need to adopt the concept of the corrosion spectrum.



The categories in the corrosion spectrum are defined and distinguished as follows:

- **Atomic effects corrosion (AEC) describes atoms degrading;** that is, mechanisms within the atom that damage or destroy the atomic structure. There are several ways AEC can occur, such as high-energy collisions between atomic particles that “split the atom.”
- **Classical corrosion describes molecules degrading;** that is, interactions between atoms and molecules such as the chemical ionic reactions that form rust and other types of visible corrosion.
- **Biological effects corrosion describes complex degradation beyond the scale of simple atomic decay or molecular chemical reactions;** that is, interactions between biological complexes, including complex organic *macromolecules*, that degrade complex systems.

Title 10 of the U.S. Code currently defines corrosion as “the deterioration of a material or its properties due to *interaction of that material with its chemical environment*” (emphasis added).<sup>1</sup> We contend that in the modern age, the traditional application of this definition is too restrictive. In order to properly conduct the broad-spectrum research needed to understand the mechanisms of materials degradation, and then develop effective methods for mitigating these effects, a broader definition is needed. This book proposes expanding the definition to include effects other than chemical reactions, recommends a comprehensive spectrum of coordinated research, describes atomic effects corrosion (AEC), and recommends strategy, policy and research initiatives to address these effects.

Strategy, policy and research are all related; in fact, our proposed strategy and policy recommendations are so closely related that we discuss them together – in essence, our recommendation is that the Corrosion Policy and Oversight Office (CPO) needs a strategic plan to coordinate the policy initiatives needed to achieve material sustainment throughout the corrosion spectrum.

1. Section 2228 of title 10, United States Code. <https://www.law.cornell.edu/uscode/text/10/2228>.

**We recommend three objectives for that strategic plan:**

**Objectives**

- 1 Develop a comprehensive policy for the corrosion spectrum.
- 2 Establish a broader coordinated research program that crosses boundaries in the corrosion spectrum.
- 3 Identify and make specific policy changes within the comprehensive policy based on research outcomes.

Research underpins and supports the strategy/policy objectives so that the CPO has a firm, scientific basis for initiatives throughout the corrosion spectrum.

**We recommend two initial research directions:**

**Initial Research Directions**

- 1 Build for Reliability, meaning conducting research that enables understanding of physical phenomena and interaction mechanisms throughout the corrosion spectrum in order to improve systems designs from the "bottom up" (from fundamental-level understanding of material properties).
- 2 Identify Thresholds, meaning determining when AEC matters to material sustainment in terms of both numbers of events and time.

This book is the second in a series published through the Potomac Institute for Policy Studies addressing "Alternative Futures for Corrosion and Degradation Research." In the first book, Dr. Robert Hummel addressed the topic of alternative futures. In this book, Dr. Charles Mueller drills into the details of AEC. A follow-on book is planned to address biological effects corrosion.

# ACKNOWLEDGEMENTS

The author would like to express his sincere appreciation to his management and colleagues at the Potomac Institute for their guidance and assistance during the research and preparation of this book. In particular, he would like to thank Mr. Michael Swetnam and Dr. Jennifer Buss for their patience and guidance in completing this complex task. In addition, he would like to thank his colleagues, Ms. Jennifer Lato and Dr. Paul Syers, without whose assistance the research, references, and manuscript for this book could not have been completed in time.

**Charles Mueller, PhD**  
Potomac Institute for Policy Studies  
Arlington, VA

# CHAPTER I: INTRODUCTION

Corrosion is a national problem estimated to cost U.S. taxpayers *billions of dollars* each year.<sup>1,2</sup> Everyone knows what happens if you leave a steel shovel out in the rain: it rusts. Rust is an example of “classical corrosion,” which occurs when the iron molecules in the shovel react chemically with the water molecules in the rain, forming what chemists call “ferrous oxide,” which is rust. Corrosion causes problems, both in Department of Defense (DoD) and society, and the DoD Corrosion Policy and Oversight Office (CPO) was established within the Office of the Secretary of Defense (OSD) to prevent, mitigate and manage corrosion in our systems and infrastructure. To define the CPO’s mission, U.S. Law (Title 10) defines corrosion as “the deterioration of a material or its properties due to a reaction of that material with its *chemical* environment” (emphasis added). While this definition served us well in the Industrial Age, this definition is no longer sufficient.

There are multiple ways materials can degrade due to interaction with their environment, shown in the **Corrosion Spectrum** below. These types of degradation are not new, but in the past, their effects were seen mainly in specialized areas such as nuclear weapons or space satellites. As technology continues to advance, these degradation mechanisms are spreading into a broader range of systems. For example, as microchips have proliferated through many systems and those chips are becoming more sophisticated, atomic effects corrosion is expanding beyond the specialized realm and into common systems.



The Corrosion Spectrum Arrow

Image credit: Alex Taliesen.

1. Gerhardus H. Koch, Michiel P.H. Brongers, and Neil G. Thompson, “Corrosion Costs and Preventive Strategies in the United States,” *NACE International*, 2002, <http://www.nace.org/uploadedFiles/Publications/ccsupp.pdf>.
2. V.S. Agarwala: “Corrosion Detection and Monitoring - A Review”, Paper No. 271, Corrosion 2000, NACE International, 2000.

**The categories in the corrosion spectrum are defined and distinguished as follows:**

- **Atomic effects corrosion (AEC) describes atoms degrading;**  
that is, mechanisms within the atom that damage or destroy the atomic structure. There are several ways AEC can occur, such as high-energy collisions between atomic particles that “split the atom.”
- **Classical corrosion describes molecules degrading;**  
that is, interactions between atoms and molecules such as the chemical ionic reactions that form rust and other types of visible corrosion.
- **Biological effects corrosion describes complex degradation beyond the scale of simple atomic decay or molecular chemical reactions;**  
that is, interactions between biological complexes, including complex organic macromolecules, that degrade complex systems.

Title 10 currently limits the CPO's authority to classical, chemical corrosion only.<sup>3</sup> Congress needs to change the law, which can be accomplished by simply removing the word “chemical” from the definition. This change will enable the CPO to pursue and coordinate research, policy and strategy across the corrosion spectrum to strengthen our nation's defense against materials degradation.

This introductory chapter briefly describes our previous research in the corrosion arena, then we introduce the concept of material sustainment as a structured, disciplined approach for addressing corrosion across the spectrum. With the context of material sustainment throughout the spectrum, we next explain in detail why the current Title 10 definition of corrosion is insufficient. The chapter concludes by overviewing the structure of the remainder of the book.

## PREVIOUS RESEARCH

In 2013, the CPO tasked the Potomac Institute for Policy Studies (PIPS) to develop a coordinated research and development program for the prevention and mitigation of corrosion for new and existing military equipment and infrastructure. The study, titled “Alternative Futures for Corrosion and Degradation Research (AFCAD),”<sup>4</sup> recommended a long-term strategy to prevent, detect, predict and manage corrosion so as to address the effects of corrosion and degradation on existing systems and new acquisitions.

---

3. Section 2228 of title 10, United States Code. <https://www.law.cornell.edu/uscode/text/10/2228>.

4. Hummel, Robert. *Alternative Futures for Corrosion and Degradation Research*, Potomac Institute Press (2014).

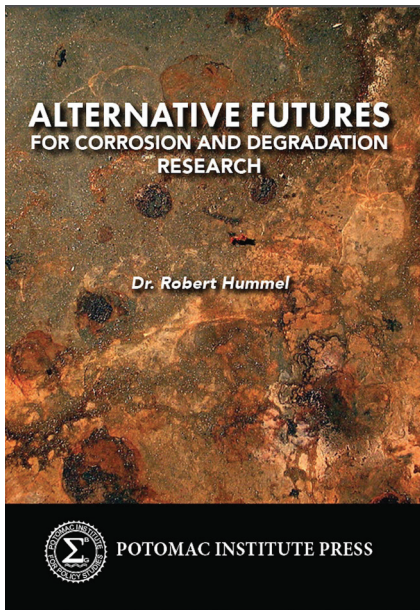

According to the AFCAD study, the task of preventing and mitigating corrosion and degradation is best approached under the rubric of “material sustainment.” That is, designing, building, maintaining, and shepherding systems such that the materials and components function for their expected lifetimes. As a discipline, material sustainment focuses on the life cycle of structural and constituent materials, and addresses the causes of degradation in all forms. In the recommendations portion of the AFCAD study, the PIPS study team recommended that the field of material sustainment should be enhanced with long term, coordinated research objectives to complement current research, which primarily focuses on specific, shorter-term objectives. In sum, the AFCAD study introduced the concept of material sustainment, which we explore and explain in the next section.

One research objective introduced in the AFCAD study was investigating the quantum effects that influence corrosion and degradation of devices and systems, such as microelectronics, at the atomic and sub-atomic scales. Subsequently, the study team identified the applicable mechanisms that result in corrosion due to quantum and related effects, which the study team has rephrased as “atomic effects” corrosion (AEC). All corrosion involves events that change the properties of materials, and materials are fundamentally made up of atoms. Classical corrosion typically involves changing the number of electrons surrounding an atom (for example, by chemical oxidation and reduction reactions). Atomic effects corrosion is differentiated by the mechanism that causes the change to individual atoms. Classical corrosion encompasses degradation interactions between multiple atoms and molecules – AEC addresses degradation *within* atoms.

That is, classical corrosion arises due to chemical reactions between molecules, normally at bulk level (many atoms or molecules); atomic effects are those phenomena that cause changes to the nuclei of atoms, fundamentally changing the atomic properties of the individual atoms affected. Atomic effects can be caused by spontaneous radioactive decay and high-energy collisions of light packets (i.e., photons) or matter particles (e.g., neutrons). In addition, atomic effects encompass other phenomena, such as field effects, that cause atoms to change or move for reasons other than the chemical effects addressed in “classical” corrosion studies. In terms of material sustainment, atomic effects corrosion can have impacts that are as important as classical corrosion, and the two are at times coupled (e.g., an atomic effect can cause a change that results in chemical reactions; the atomic effect thereby becomes the initiating mechanism for classical corrosion).

While classical corrosion is well-developed scientific field, atomic effects corrosion and its impacts on materials and systems of interest to the DoD are not yet well and widely understood. To increase understanding of corrosion mechanisms and then improve our ability to ensure the material sustainment of systems with implications for U.S. national security requires addressing the effects of corrosion across the spectrum, not just one part of it (classical corrosion). The context for accomplishing this goal is addressed in the next section, which addresses material sustainment as a discipline.

## THE DISCIPLINE OF MATERIAL SUSTAINMENT

Humans build things with the intention that they should last. Throughout the transition from hunter and gatherers to agricultural communities and societies based on population centers, humans have devised tools, equipment, and dwellings to perform through a lifetime and beyond.

As a result, humans found long ago that certain materials are better suited at making things that last (for instance, the figure below shows the development of longer lasting, better artificial lights.) For example, the earliest examples of ceramics are found in figurines from at least 25,000 BC.<sup>5</sup> Pottery used for cookware and vessels dates from 20,000 BC.<sup>6</sup> Metals came later, with gold used for jewelry appearing around 6,000 BC, and subsequent metals such as copper, silver, and lead appearing more than 5,000 years ago.<sup>7</sup>

5. John H. Lienhard, "No. 359: The Dolni Vestonice Ceramics," *University of Houston*, 24 Nov 1989, Accessed 4 Sept 2010, <http://www.uh.edu/engines/epi359.htm>.
6. Xiaohong Wu, Chi Zhang, Paul Goldberg, David Cohen, Yan Pan, Trina Arpin, Ofer Bar-Yosef, "Early Pottery at 20,000 Years Ago in Xianrendong Cave, China," *Science* 336, no. 6089 (June 2012): 1696–1700
7. "Discovering Metals – A Historic Overview," in *Metallurgy for the Non-Metallurgist* (ASM International, 2011). [http://www.asminternational.org/documents/10192/3212401/05306G\\_Sample\\_BuyNow.pdf/ab60c086-2c71-4de0-91f6-aad1112cf4dc](http://www.asminternational.org/documents/10192/3212401/05306G_Sample_BuyNow.pdf/ab60c086-2c71-4de0-91f6-aad1112cf4dc).

vexworldwide/www.shutterstock.com





The Copper Age is ascribed to the period 3,900 BC to 2,400 BC,<sup>8</sup> which transitioned to the Bronze Age, wherein tin was added to copper to form an alloy that is more easily worked and fashioned into tools and implements.<sup>9</sup> The introduction of the Iron Age after the Bronze Age, around 1,200 BC, is most significant.<sup>10</sup> Iron is more abundant and more easily smelted, and when combined with carbon, it can produce stronger and better tools (and weapons). However, it can deteriorate and, of course, rust.<sup>11</sup>

By the way, to determine the age of the ancient artifacts mentioned above, scientists use radiocarbon dating – which is based on an atomic degradation effect: the amount of the carbon-14 isotope remaining in an object. As objects grow older, the carbon-14 in them decays – by measuring the amount of carbon-14 relative to the other (more stable) carbon isotopes, scientists can estimate an ancient artifact's age. So atomic effects degradation is not always a bad thing, and radiocarbon dating is one of the best mechanism we currently have for determining the age of ancient items. What we are concerned about in this book is atomic effects that do indeed have deleterious effects.

The ultimate cost of a tool or object is the amortization of its cost of construction over its period of service. Accordingly, the longer the service life, the lower the overall cost. There are multiple ways to guarantee a longer useful life span. One of the most important is to employ materials that resist corrosion and degradation.

Interestingly, the development of improved tools in the Iron Age coincided with a large increase in the development of weapons that used steel, which included chariots, armor and shields, swords and daggers, and spears.<sup>12</sup> Whether it was the need for better tools, or an arms race to produce stronger weapons, the military has consistently been at the forefront of the acquisition of objects that have substantial permanence. In part, the military value of new weapons in the Iron Age was a consequence of steel's strength and hardness. To this day, the military is interested in acquiring things that will last in storage, or in use, for known and predictable lifespans (e.g., sophisticated military aircraft, such as that depicted in the figure on page 18). If weapons or military equipment fail prematurely due to degradation, our military capability will be adversely affected. Therefore, strength remains a major performance goal of materials used in military applications. Today, however, material sustainment is not merely a direct result of the strength of the constituent materials, because weapons have become more sophisticated and

- 
8. "Dawn of an Age of Copper," Smithsonian National Museum of Natural History, Accessed 21 Sept 2015, <http://www.mnh.si.edu/exhibits/cyprus/chalcolithic.html>
  9. Childe, V. G., *The Bronze Age* (Cambridge, UK: University Press, 1930).
  10. Jane C. Waldbaum, *From Bronze to Iron. The Transition from the Bronze Age to the Iron Age in the Eastern Mediterranean* (Studies in Mediterranean Archaeology, 1978) 106
  11. Alec Groysman. *Corrosion for Everybody* (Springer Netherlands, 2010).
  12. Gregg Newby, "Weapons Used in the Iron Age," Synonym, Accessed 21 Sept 2015, <http://classroom.synonym.com/weapons-used-iron-age-18314.html>



Nuno Andre /www.shutterstock.com

dependent on complex subsystems such as microelectronics. Sustainment remains an important goal for military equipment, both in terms of cost control and sustained readiness, and accomplishing that goal is getting more complex as technologies become more sophisticated.

As a discipline, the goal of material sustainment is to ensure that things have reasonable, predictable lifespans with minimal maintenance requirements. Therefore, material sustainment must address causes of all forms of degradation in all technologies, by virtue of using materials and construction techniques that prevent or mitigate degradation due to external environmental causes. There are multiple ways of categorizing causes of degradation. As we have already discussed, classical corrosion often arises from chemical or electrochemical action by the environment that causes degradation on materials used in DoD systems.

There are other causes of corrosion that are less common, or less visible, but can still cause premature aging and failure. For example, some materials simply undergo dissolution, for example by dissolving in water. Mechanical wear is generally not considered corrosion in and of itself, but is often a component of degradation that can involve multiple causes. Indeed, metal fatigue involves structural changes to the organization of grains in metal, and is generally caused by mechanical stresses and cycles imposed by purely physical (as opposed to chemical) phenomena. In 1954, the consequences of metal fatigue were dramatically demonstrated with the failure of two de Havilland aircraft.<sup>13</sup>

---

13. Ministry of Transport and Civil Aviation, Civil Aircraft Accident: Report of the Court of Inquiry into the Accidents to Comet G-ALYY on 8th April, 1954 (London: Her Majesty's Stationery Office, 1955) [http://lessonslearned.faa.gov/Comet1/G-ALYP\\_Report.pdf](http://lessonslearned.faa.gov/Comet1/G-ALYP_Report.pdf).

Radiation that impinges on materials is another cause of degradation. For example, polymers subjected to ultraviolet light (UV) will eventually become brittle, crack or break.<sup>14</sup> Other kinds of radiation: X-rays, gamma, beta, and alpha radiation, can also cause various kinds of material changes, from ionization of molecules, to causing nuclei of atoms to transmute through fusion or fission. Microelectronics in particular (see image below) are susceptible to changes induced by radiation. As feature sizes (the size and spacing of electronic components in a microchip) decrease and component densities increase in microchips, radiation-induced effects can become even more pronounced. On the other hand, for some atomic-level mechanisms, decreasing feature sizes increases chips' radiation tolerance. As we'll explain later in the book, the impact of radiation on microchips is a complex topic.

Materials can also be subjected to fields that cause degradation. Gravity slowly causes the atomic structures of silica molecules in glass to deform over time. Electrical fields in semiconductors and electronic circuits can cause atoms to become displaced, causing degradation. Even magnets can degrade over time due to thermal effects that cause

---

14. Peter Rhys Lewis, Ken Reynolds, and Colin Gagg, *Forensic Materials Engineering: Case Studies* (CRC Press: 2004).

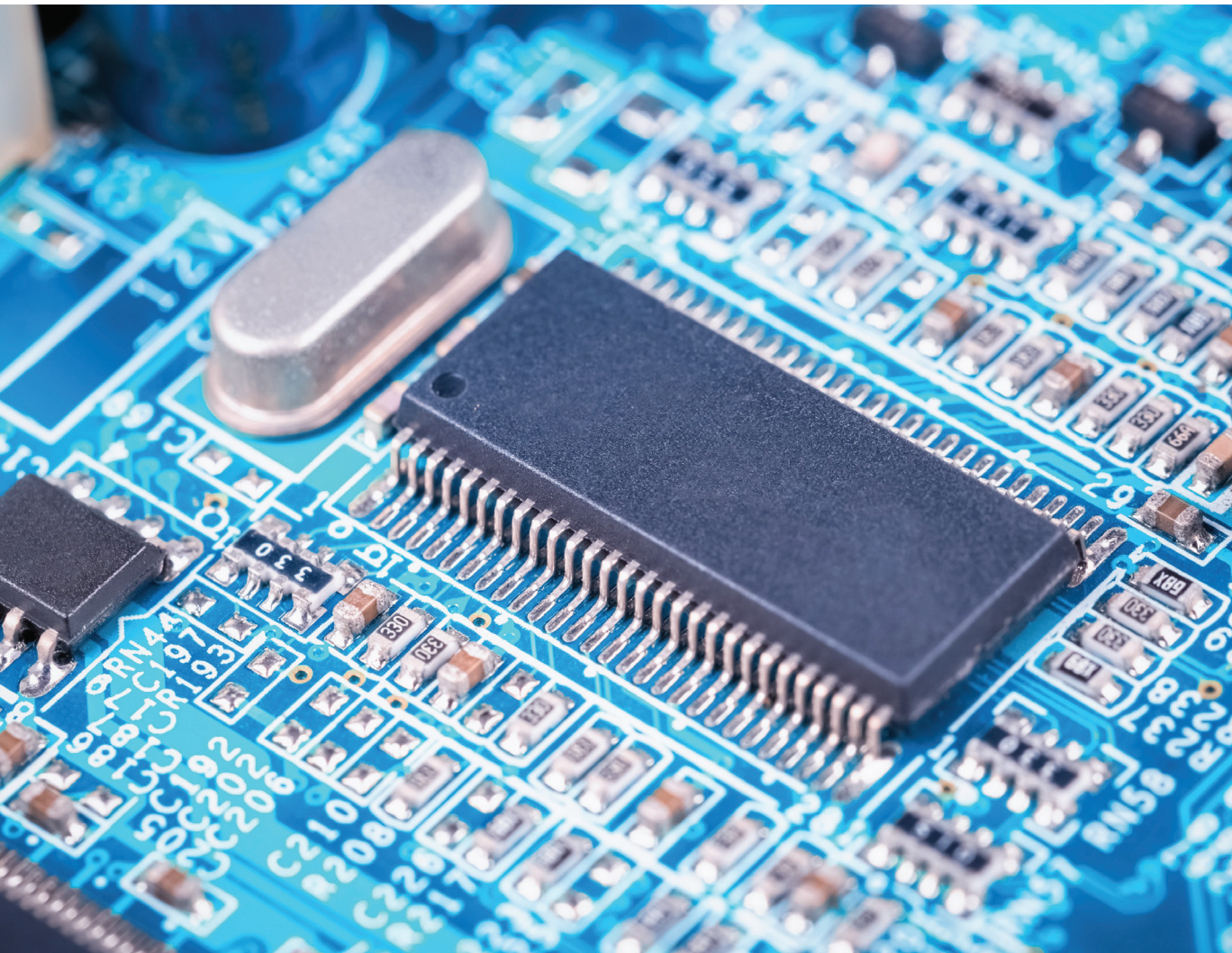

their magnetic strength to wane; these effects are particularly important for motors that depend on compact powerful magnets.

A material's properties are determined by the composition and arrangement of its substances. When the material experiences a change in its composition or molecular arrangements, that material has degraded from its original state. For many materials, a large number of atomic changes must take place before the properties we tend to care about start to become compromised. However, this does not change the fact that any one change might be the initiating event that enables additional or more rapid degradation of that material. Knowing the full spectrum of processes that lead the changes in a materials property is critical to a truly successful material sustainment strategy.

We use the term "material sustainment" as opposed to "corrosion and degradation prevention and mitigation" in order to emphasize the primary goal: **to ensure that systems function as designed for their designed lifetimes**. During its lifetime, the system should not suffer from unexpected loss of functionality or the need for unexpected servicing due to deterioration from external (environmental) effects. Instead, systems should have predictable performance, and maintenance costs required by degradation from external influences should be minimized. Accordingly, from the standpoint of developing good policy and directing research in areas that have the greatest impact, it is important to understand the broad set of environmental influences and physical phenomena that can cause degradation to materials and, thus, the functionality of a system.

The reason that corrosion is traditionally restricted to causes attributed to "external" influences is the perception that the external environment is less controllable, whereas internal effects are more an issue of design and use, which are under the developer's and user's control. This perception is true only to a certain extent. Sometimes, internal influences have to do with required design elements. For example, radioactive materials will degrade according to their half-lives, and that might be an internal design element that is required for functionality – as noted in the use of radiocarbon dating for ancient artifacts, sometimes radioactive decay is key to the use of such techniques. In other cases, the internal components might show incompatibilities that are not expected or known when the system is designed, and as a result, these components cause degradation in functionality that is not controlled by the user. Galvanic corrosion, in which two or more metals in contact corrode due to electrochemical reactions between the metal interfaces, is a common example of incompatible materials corroding.

What is normally omitted from the study of corrosion is degradation that is due to wear and tear. Wear and tear is usually considered to be an internal effect, in the sense that the system operates under normal conditions, and that expected degradation effects occur independent of the external environment. Metal fatigue would generally be considered an example of wear and tear. Of course, wear and tear can also cause unexpected failures. Thus, wear and tear should not necessarily be omitted from the broadened field that we are calling material sustainment. Unexpected failure can be the result of the lack of a good prediction model of how wear and tear will degrade a

system, or failures increase because the system is used in unexpected ways. In essence, a well-designed material sustainment approach not only addresses individual effects, but the relationships of multiple, potentially coupled, effects.

Further, wear and tear effects can work in conjunction with corrosion and degradation that does involve the external environment. To the extent that systems interact with influences from the external environment, corrosion prevention and mitigation generally involves proactive defense mechanisms, including defenses against wear and tear, along with combatting corrosion due to the environment. Environmental influences can include weather, temperature, physical stresses, electromagnetic fields, magnetic fields, radiation, or other effects. Some of these effects could be generated through the interaction of materials within the system, as in galvanic corrosion from contact between dissimilar metals, and others can be strictly dependent on external influences.

To promote material sustainment, and the associated research and policies to address degradation effects that cut across chemical and other effects, the distinctions between wear and corrosion should be viewed as flexible. The intent of material sustainment is that systems designed and acquired by the military, or any branch of government, should have predictable life spans that are free from surprise premature degradation, whatever the cause.

Thus, the quest for material sustainment involves combatting myriad causes of degradation. These causes often act in compound ways, and sometimes in ways that are not yet fully understood. Classical corrosion, as we might call it, has been a major hindrance since the Iron Age, and therefore, chemical and electrochemical causes are relatively well understood. However, other types of degradation are less obvious and in some cases less understood, and the consequences of these types of degradation can be more difficult to prevent or mitigate. From a strategic perspective, a "champion" is needed to coordinate the research and policy needed to combat degradation, and we argue that the CPO is ideally and uniquely positioned to be the champion of material sustainment.

Particularly in the area of microelectronics, with increasing design complexity and component densities, degradation may be caused by relatively few single events that significantly impact performance, and therefore degradation of microchips is becoming increasingly important. To assist in identifying the research, policy, and strategy issues associated with the less well-understood degradation mechanisms related to material sustainment, this book focuses on **atomic effects corrosion (AEC)**, which is corrosion at the atomic level. The third volume planned for the book series featuring "Alternative Futures for Corrosion and Degradation Research" will address biological effects corrosion, which involves even less well-understood complex degradation mechanisms, including microbiological and macromolecular effects.

In the next section, we complete the case for adopting the discipline of material sustainment, and the role of CPO as its champion, by explaining why the current definition of corrosion is inadequate. These concepts are fundamental to improving material sustainment across the corrosion spectrum. Simply put, limiting corrosion to a single part of that spectrum is insufficient.

## THE CURRENT DEFINITION OF CORROSION – AND WHY IT IS INADEQUATE

The U.S. Code Title 10, Subtitle A, Part IV, Chapter 131, section 2228, subsection (f)(1) defines corrosion as follows:<sup>15</sup>

**The term “corrosion” means the deterioration of a material or its properties due to a reaction of that material with its chemical environment.**

This same law states that the DoD has a responsibility for the prevention and mitigation of corrosion of military equipment and infrastructure of the DoD. As such, the clear intention is to prevent or mitigate degradation as defined by the term “corrosion.” (The photographs on the next page depict multiple cases of classical corrosion.) The CPO is based within DoD, but since corrosion and degradation affect all aspects of society, their oversight of solution paths impacts all levels of government and society. However, the current notion of “chemical environment” is too limiting. Chemistry is just one of the processes by which material properties change, and the prevention, detection, prediction and management of materials degradation, by any mechanism, is part of the CPO’s mission. In order to implement material sustainment as a discipline, the CPO needs to be able to address corrosion across the spectrum from atomic, to classical (chemical) to biological effects.

The degradation of materials due to environmental effects depends on the kinds of environments, and their consequent effects, in which we operate and on the materials we are using in those environments. In the prehistoric (and thus pre-science) era, the relevant environmental effects were often primarily biological. When a caveman (let’s name him “Og”) selected a stout tree limb and made it into a club, he knew nothing about the scientific mechanisms of the environment in which he was operating. What Og did care about was the integrity of that club: if it rotted, it was no longer useful to him. Whether it rotted due to chemical corrosion (e.g., molecular changes caused by chemical reactions induced from soaking the club in water, for example) or biological activity (e.g., bacteria/mold eating the wood) did not matter: what Og knew was that he needed a strong club to survive. Of course, we are well beyond the prehistoric era, and we can use science to systematically investigate the underlying mechanisms of degradation, and develop measures to prevent or mitigate degradation.

---

15. Section 2228 of title 10, United States Code. <https://www.law.cornell.edu/uscode/text/10/2228>.



So why is our current definition limited to chemical effects? We surmise that until recently, these were the effects that caused the most prominent degradation of materials. In the various "metal ages" (bronze, iron, etc.), chemical reactions were the primary, and certainly resulted in the most observable, degradation effects. As we moved into the Industrial Age, our tools and our equipment were based mainly on metals and other materials that corroded due to chemical reactions. Most are familiar with the rust that forms on iron or steel objects, or the green patina that forms as copper corrodes. Societies are affected by infrastructure degradation, such as bridge structures crumbling and ultimately collapsing. All of these effects can be explained as "the deterioration of a material or its properties due to a reaction of that material with its chemical environment."

The problem with limiting corrosion to the "chemical" environment is that even the common terminology of corrosion of metals involves multiple influences including the environment that are not, strictly speaking, exclusively chemical in nature. For example, stress corrosion cracking involves the confluence of physical material stress as well as chemical interactions. Ultraviolet radiation can cause ionization of polymeric materials that can cause degradation in the properties of polymers, such as coatings or plastics. The proposed discipline of material sustainment cannot be realized if we are interested in degradation solely due to a chemical environment. If radiation or an electromagnetic field causes degradation that reduces a system's useful life cycle due to interaction with the external environment, a material sustainment approach must be concerned with those mechanisms, too. Since the intent is to provide material sustainment in DoD systems and infrastructure, consideration of all external environments and physical processes that can cause degradation of systems is of importance to DoD when designing, fielding, and maintaining systems. In short, material sustainment must address degradation across the spectrum, not limit itself just to classical, chemical-reaction based corrosion. See The Corrosion Spectrum figure, page 25.

As technology advances, the importance of mechanisms in addition to chemical reactions is increasing. For example, we already know about degradation affects at the atomic level that occur in nuclear materials: weapons, power plants, nuclear waste, and the nuclear waste storage containers. Furthermore, we understand many of the combinations of effects that can occur in, for example, nuclear waste storage containers that deteriorate due to both chemical and atomic effects.<sup>16</sup> Atomic effects corrosion in the nuclear arena falls under the purview of the Department of Energy (DoE), and DoE has an extensive research and monitoring program to detect and mitigate AEC in nuclear programs.

However, "nukes" are not the only arena in which atomic effects are observed. For example, the "tin whiskers" that occur in electrical devices were first observed in the vacuum tube era of the 1940s and 1950s. Though tin whiskers have been studied extensively, no one is certain what causes them. In addition, as microelectronics become more sophisticated, a few atomic-level events can result in significant degradation effects that

---

16. Hummel, Robert. *Alternative Futures for Corrosion and Degradation Research*, Potomac Institute Press (2014).



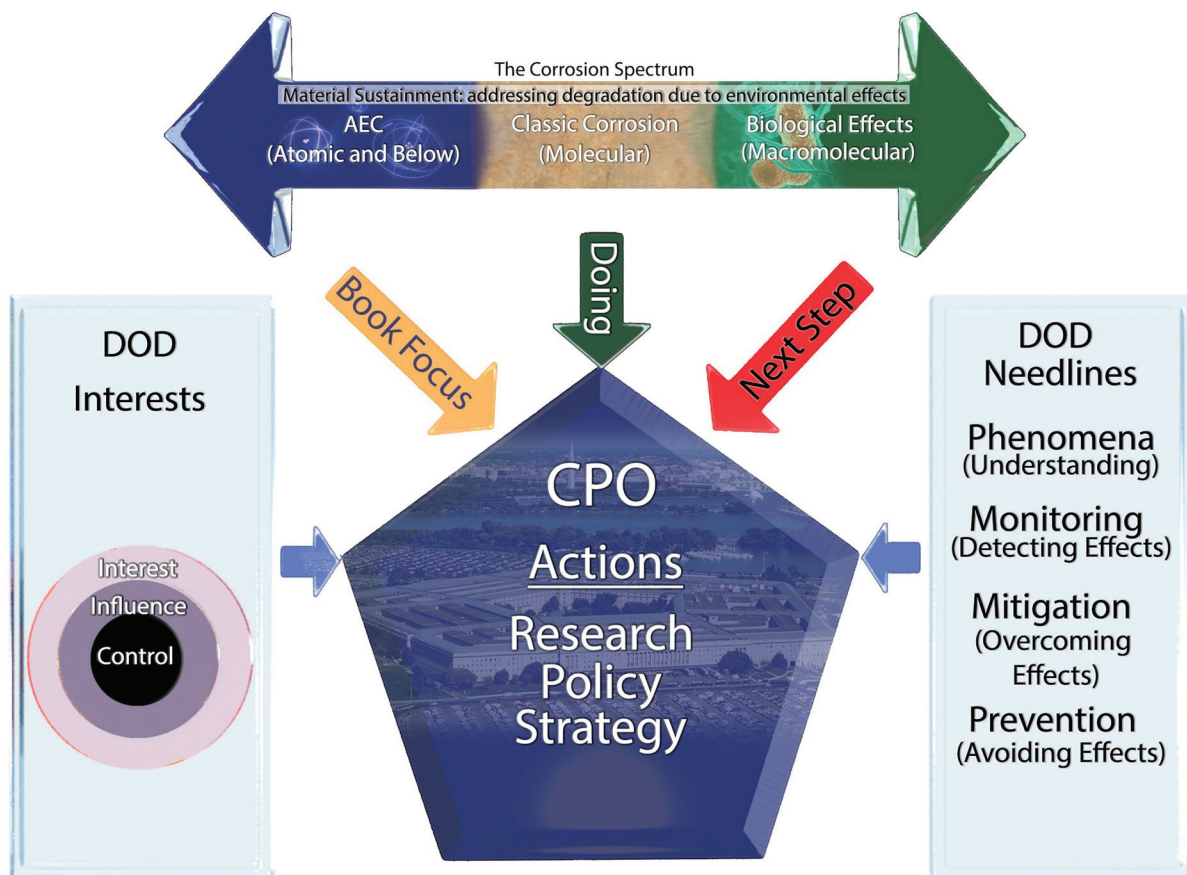

Corrosion Spectrum Diagram  
Image credit: Alex Taliesen

are discernible at the macro level in terms of a microchip's ability to function properly. The point is that materials degradation can occur in numerous modern technologies by mechanisms that are *not explained by the limited, chemical reactions only*, definition of classical corrosion.

Though this book does not explore macromolecular biological effects in detail, it is apparent that atomic effects are not the only new (relatively speaking) mechanisms by which materials degradation occurs. Microbiological effects have been observed in numerous areas, and these mechanisms are also not fully understood. For example, it appears that there are biological mechanisms causing even synthetic materials such as tents to "rot" – even though the tents are not constructed of biologically-based cloth. These mechanisms are not yet fully determined – they may be purely chemical, they may be chemical reactions induced or catalyzed by microbiological agents, or they may be combinations of multiple-cause mechanisms in the macromolecules that we increasingly use in synthetic materials. We call these "biological effects corrosion" and plan to address them in the third book in this series "Alternative Futures for Corrosion and Degradation Research."

The bottom line is that identifying chemical reaction mechanisms is no longer sufficient for dealing with materials degradation and promoting the discipline of material sustainment. For this reason, we propose that the definition of corrosion needs to be broadened. It should not be limited to deterioration due to reactions with the chemical environment – it should include degradation due to all environmental effects. Therefore, we propose that the definition of corrosion should be updated to:

**Corrosion means the deterioration of a material or its properties  
due to interaction of that material with its environment.**

In short, corrosion should be broadened to include materials degradation throughout the spectrum, and include AEC, classical corrosion, and biological effects corrosion. In concert with this definition, we further recommend the adoption of the term “material sustainment” to describe the coordinated research, policy and strategy for preventing, detecting, predicting, and managing materials degradation. The remainder of this book focuses on AEC, but as we address this non-classical corrosion mechanism, the reader should keep in mind that biological effects are also important. Whether AEC or biological effects, limiting material sustainment to classical, chemical-reaction effects is *no longer sufficient*.

## ORGANIZATION OF THE BOOK

The main body of this book is designed to be readable by reasonably educated, non-scientist laymen trying to understand AEC, its impacts, and the research, policy and strategy implications associated with a coordinated approach to material sustainment. Therefore, the main body comprises two additional chapters.

Chapter 2 provides a description of the various kinds of AEC. The description begins with the phenomenology of AEC degradation mechanisms: high-energy collisions, fields, and spontaneous decay (for context, we also briefly address the low-energy collisions associated with classical, chemical corrosion). The phenomenology overview is followed by specific applications in which “significant” AEC impacts can occur. These applications include specialized applications such as space and nuclear systems, but also increasingly common, widely proliferating microelectronics. This book is unclassified, which limits the discussion of some nuclear system details; we can, however describe many of the phenomena that take place in these systems. For example, the first book in the *Alternative Futures for Corrosion and Degradation Research* series described atomic effects in nuclear systems at the unclassified level.<sup>17</sup> In this book, we summarize these effects only: further detail about the specific mechanisms of AEC and how they affect specific systems could move into the classified arena, and we purposely avoid that possibility.

Chapter 3 provides our recommendations for the CPO in the areas of strategy, policy and research. These three topics are closely interrelated, and in fact we discuss strategy and policy together because in the area of material sustainment, these topics are intertwined. Research underpins strategy and policy, and we segment it from strategy and policy only to present the recommendations in a logical order.

---

17. Hummel, Robert. *Alternative Futures for Corrosion and Degradation Research*, Chapter II; Potomac Institute Press (2014).

This final chapter begins with an overview of strategy, policy and strategic planning for policy identification and implementation, and recommends strategic and policy initiatives we believe the CPO is ideally suited to implement. The research recommendations that follow the strategy/policy section are intended to support the development of both policy and strategy. Chapter 3 also includes descriptions of DoD interests, to include interests in areas that other agencies “own” (e.g., NASA for space, DoE for nuclear systems). These recommendations are in no fashion an attempt to broaden DoD’s control: they are simply factual descriptions of the interests DoD has in the systems, and associated material sustainment of those systems, in these arenas. The purpose of including them is to provide context for the recommendations. With regard to research recommendations, we reinforce the need for a coordinated research agenda. This is not a criticism of the extensive and excellent research, both completed and ongoing, in specific areas. It is based on an observation that “stove-piped” research alone is insufficient to fully inform the policy and strategy associated with the complex mechanisms associated with material sustainment in the modern age. We also provide examples of research to “prime the pump” for research in support of specific strategy and policy changes.

All three chapters of the main body of this book are structured so that an interested reader can complete them in a single sitting. For the reader interested in more depth, and additional scientific/technical detail, the book includes two appendixes. The first appendix contains additional material on the classification structure of materials. This appendix is not intended as a “textbook,” but an introductory compilation of the material science associated with the corrosion spectrum. The second appendix provides more scientifically oriented descriptions of examples of AEC in DoD. Both appendixes are targeted to the more scientifically inclined reader who wants to dig into the details in more depth than the main body of the book.



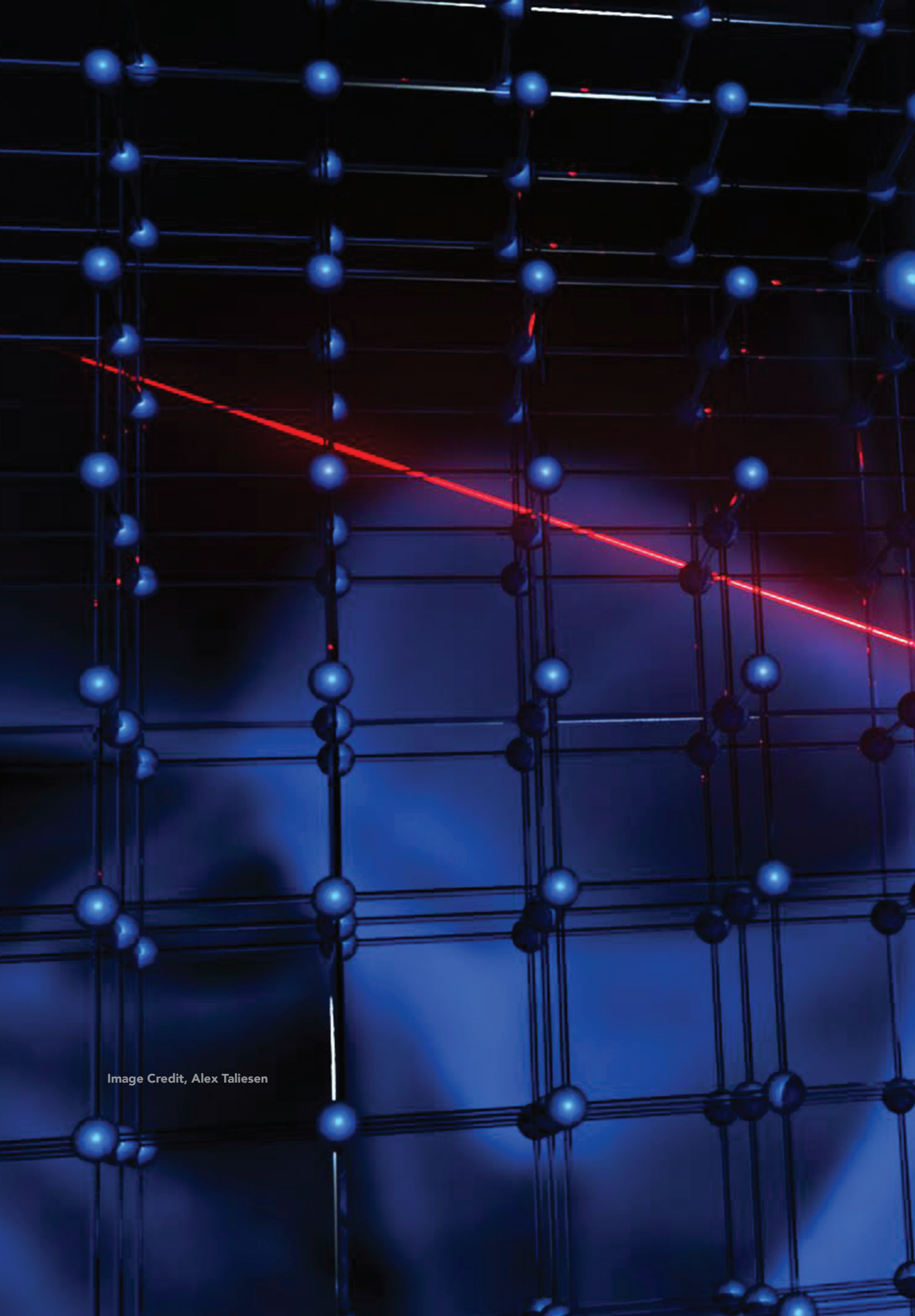

Image Credit, Alex Taliesen

# CHAPTER 2: THE SCIENCE OF MATERIALS DEGRADATION

This chapter provides a brief description of materials degradation effects and the associated science. The science is described so that a reasonably educated non-scientist can understand it: its purpose is not to delve into the details of the science (which are overviewed in Appendix 1), but to enable the reader to understand the various effects, what is known about them, and to point out some of the unknowns. We do describe some of the mechanisms using scientific terms, but we keep those descriptions at a relatively high level.

To provide a proper context for understanding AEC, the chapter begins with a reprise to the “corrosion spectrum,” which includes atomic effects (i.e., AEC), chemical reaction (e.g., ionic effects) – which is classical corrosion – and biological effects (i.e., complex corrosion). Next, the chapter describes the various forms of degradation within this spectrum, how AEC is unique, and the way AEC affects nuclear weapons, nuclear power, nuclear waste disposal, space, and perhaps most significant of all: microelectronics. As technology continues to develop and become increasingly dependent on microelectronics, AEC associated with microelectronics has implications across the information technologies, control, monitoring, and other systems in both the DoD and in broader society.

## INTRODUCTION – THE CORROSION SPECTRUM

The corrosion spectrum (see figure at the top of the next page) describes the various contexts of materials degradation. Its intent is to provide a way to classify the distinct pathways, the different facilitating causes, and the diverse impacts of degradation. The underlying physical processes behind materials degradation define the corrosion spectrum. We propose that this spectrum begins at the atomic level, which we categorize as atomic effects corrosion (i.e., AEC), where subatomic particles and spontaneous decay cause degradation of material properties. As we move across the spectrum the size of the degradation particles increases to that of atoms, ions and small molecules bringing us into the realm of classical chemical corrosion (e.g., ionic effects). The corrosion spectrum ends as the size of the degradation particles reaches that of macromolecules, such as those produced by biological organisms, leading to complex interactions that facilitate the degradation of micro- and macrostructures in materials (i.e., biological effects).

**The underlying physical processes behind materials degradation define the corrosion spectrum.**

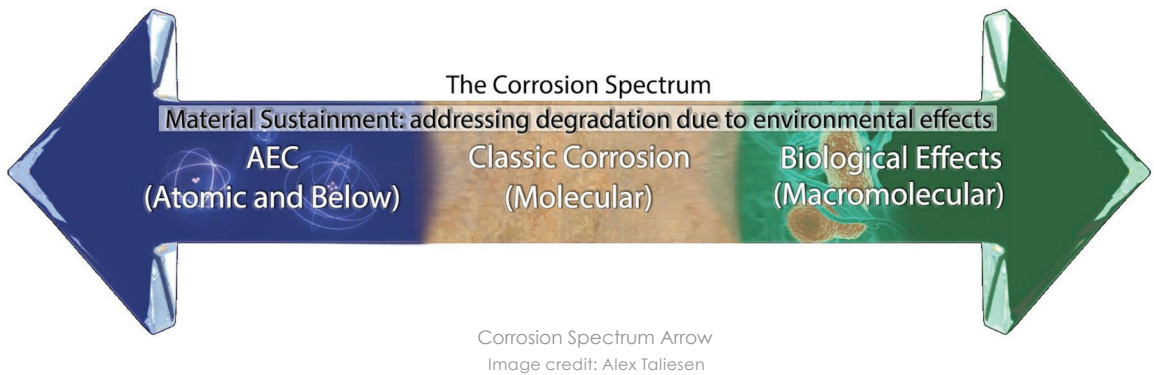

Given the topic of this book, it is reasonable to question why we claim AEC is a different mechanism than classical, chemical-reaction based corrosion. The term AEC identifies the class of mechanisms by which a material can become degraded or dysfunctional because of changes in its properties brought about through processes resulting from interactions with subatomic or force carrying particles that affect the building blocks of the atoms in the material. These processes are distinct from the traditional chemical corrosion processes of degradation considered by the DoD, and include nuclear chemistry, radiation effects, and spontaneous decay. The common thread between all of these AEC processes is that they impact individual atoms through non-chemical means.

Because the properties of individual atoms do not characterize most of the things that are important to us, it is easy to think physical changes to an individual atom can have no impact on our daily lives. However, diseases like cancer remind us that when things degrade on the smallest scale, the result can be serious. A cancer that begins in an individual cell degrades the nucleus of that cell, which can spread to other cells, which collectively degrade the tissue or organ, which degrades the human being that is made up of cells, tissues and organs. Fundamentally, the same effect can happen via AEC if, for example, a neutron collision alters an atom in a transistor within a microchip, which degrades the surrounding material lattice, which sets off a degradation cascade that impacts the functionality of the transistor, the chip, the computer, and ultimately the entire system (e.g., weapon system). In both examples, the types of degradation described here *did not occur through classical, chemical reactions*. Thus, AEC is about studying and understanding what makes atomic-level degradation of materials different than classical corrosion effects.

This is not to say that the transistor described above (and the chip/computer/weapon system, of which it is a part) cannot also undergo classical corrosion. If the transistor were placed in the bottom of the ocean, it would degrade through classical corrosion processes. The designers of the transistor understand this and thus go to great lengths to control the environment around the transistor to ensure it will not be exposed to phenomena that can cause classical corrosion. They do not, however, design the transistor to be safe from atomic reactions, and thus our transistor represents a material that, while resistant to classical corrosion processes, is susceptible to AEC.

The goal of material sustainment should be to design materials so that *all* degradation processes are accounted for as best as possible. DoD, and society in general, do not want to build essential technology and infrastructures that are only protected from a fraction of the processes that can cause them to fail. It is therefore necessary to understand and make sense of all material degradation processes – especially in cases where AEC (or other processes such as those caused by biological effects) can become significant. This is what the term “corrosion spectrum” is intended to convey.

The corrosion spectrum provides context to the question of what it means when we say a material has been degraded. It points out that classical corrosion is just one type of degradation process that can cause systems and infrastructures to fail due to interaction with their environments, which means that we need to understand the other mechanisms. In order to address corrosion in any part of the spectrum, it is necessary to start by understanding the science of matter and how the behaviors of materials are dependent on the properties of the individual atoms that make them up. With a more complete understanding of the building blocks of materials, a discussion about the properties of materials and the ways they can degrade incorporates not just chemical reactions, but also the atomic, molecular, and larger-scale macromolecular components that comprise materials. The corrosion spectrum addresses all these mechanisms, and in doing so, the difference between atomic effects, classical, and micro- or macro-biologically induced degradation become apparent. The goal is to ensure that the materials the DoD acquires are capable of withstanding all degradation pathways. To begin understanding the corrosion spectrum, let's start with the fundamentals: the science of matter.

**The goal is to ensure that the materials the DoD acquires are capable of withstanding all degradation pathways.**

## THE SCIENCE OF MATTER

Starting with fundamental particles such as quarks, scale (physical size) increases from fundamental particles, to atoms, to simple molecules and ions, to complex molecules and ions, to macromolecules. As these building blocks aggregate into micro and macrostructures they can be further classified into four common material classifications: metals, ceramics, polymers, and composites. With each type of classification, we can thus describe





the material that results from the assembly of these building blocks. Metals are large aggregates of metallic atoms held together into precise atomic geometries by special metallic bonds and this gives rise to the properties we associate with metals. Polymers are aggregations of carbon-based molecules held together through complex molecular bonding schemes that lead to the molecular structures upon which polymer properties depend. Technologies such as a laptop computer incorporate many different building blocks, and it is the combination of all the building blocks working in concert that gives the laptop its functionality (see image above). A laptop depends on more than a single transistor to give it the capability of accessing the Internet.





The laptop, however, still needs the individual transistors inside it to correctly execute their limited functions to be able to perform its more complex functions. It may be able to continue working if one transistor fails, but how many transistors need to fail before the laptop is critically impaired? Expanding from this example to the larger question, the answer changes for different devices, and different functions of a single device – especially with more complex pieces of technology. This is key to understanding the corrosion spectrum.

Understanding materials on a fundamental level enables us to systematically investigate and understand the types of degradation pathways possible throughout that material's lifetime. We will continue to have gaps in our material sustainment strategies if we fail to address the science of all degradation mechanisms associated with the materials we use to build systems. This is why it is important to recognize that chemical degradation – also known as classical corrosion – is only one of many degradation mechanisms. Many claim that the chemical/ionic mechanisms of degradation are well understood, and we agree. What is less well understood are the degradation mechanisms caused when subatomic particles smash into the atoms of a material (i.e., AEC): there is a lot of science that addresses individual mechanisms, but less recognition of how and when these degradation mechanisms reach the point where degradation *matters* to the materials we use. To lay the foundation for understanding the distinctions between AEC and classic corrosion, we will briefly focus on the differences between atom, ions and molecules.<sup>1</sup>

## Atoms

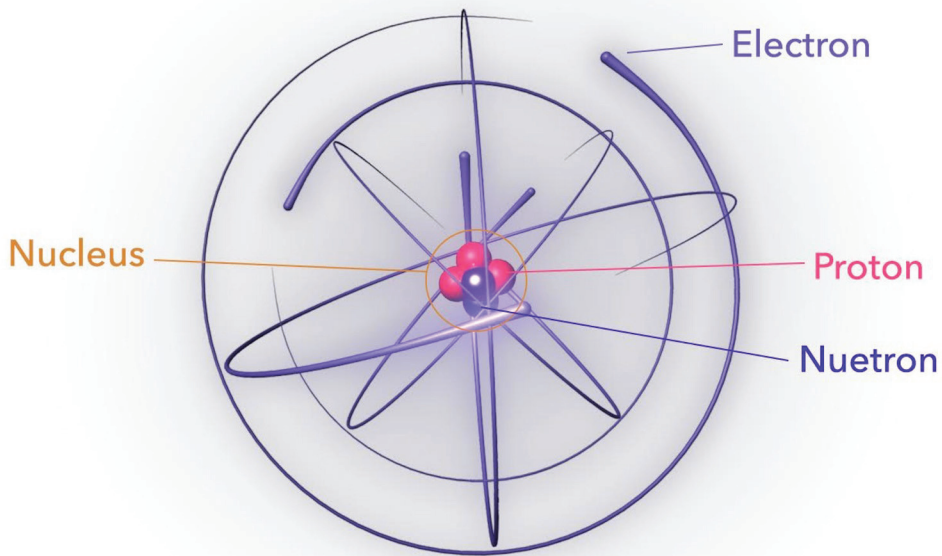

The Atom

Atom/Alex Taliesen

1. There are also important distinctions between molecules and macromolecules, and between polymers, ceramics, metals and alloys, and composites. However, those are topics more important to biological effects corrosion (BEC) and we defer them to the next book in the "Alternative Futures for Corrosion and Degradation Research" series.

The anatomy of the atom includes a central structure called the nucleus, which is surrounded by electrons (see the figure on page 34). While an electron is a fundamental particle (it is indivisible), the nucleus is made up of protons and neutrons. These protons and neutrons are, themselves, aggregations of other fundamental particles we call quarks. The nucleus of the atom is held together by the nuclear strong force (an attractive force between nuclear particles), which manifests from the behaviors of quarks. The nuclear weak force (which allows quarks to transmute into other quarks, which can change nuclear particles, which can in turn break up the nucleus, resulting in radioactive decay) also affects the behavior of quarks and so it plays a role in AEC as well.<sup>2</sup> Protons and electrons carry opposite electric charges (by convention, the proton is “positively” charged and the electron is “negatively” charged) and the neutron carries no charge. The particle’s electric charge interacts with electromagnetic forces and these interactions are critical to understanding how and why chemical reactions occur.

An atom’s properties depend on the number of protons and neutrons in its nucleus (see the figure below). An element is defined by the number of protons (and equal number of electrons) an atom has, and the various isotopes of a single element are distinguished by changing the number of neutrons in the atom. Deuterium, for example, is an isotope of hydrogen. Smaller, lighter elements such as hydrogen (H) and helium (He) have few protons and neutrons; larger, heavier atoms such as uranium (U) have more protons and neutrons giving them a higher atomic weight. The neutron is necessary to overcome the repulsive forces (“like charges repel”) that occur as protons aggregate within the nucleus. To balance out the electromagnetic forces, each atom has one electron for every proton. Elements such as hydrogen, helium or iron therefore represent a specific, stable arrangement of protons, neutrons, and electrons.

2. Specifically in the spontaneous decay of atoms associated with radioactivity.

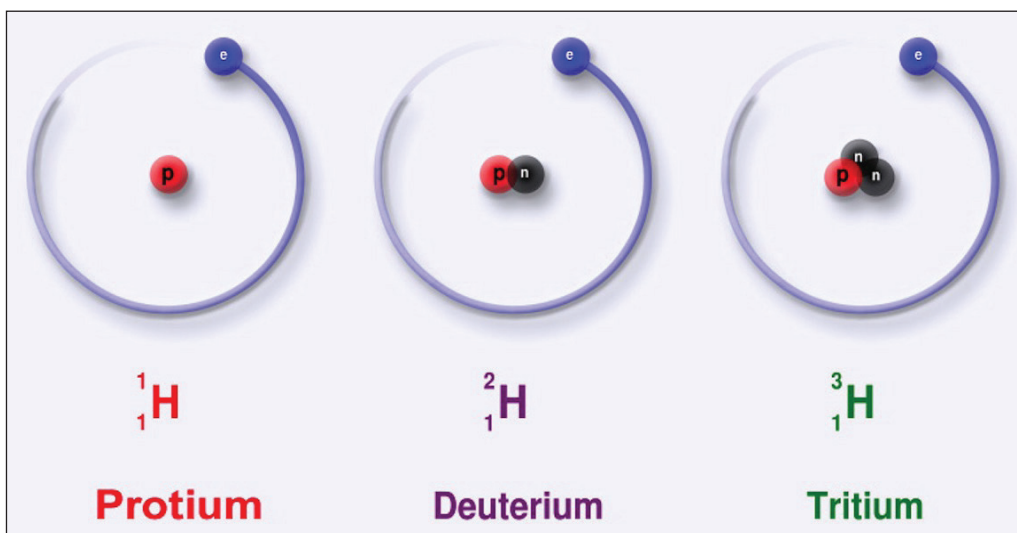

The three isotopes of hydrogen

However, not all atoms are stable for very long. Large atoms like uranium have isotopes such as uranium-235 that can decay spontaneously – through a process known as fission – leading to a large release of energy and two new elements (Kr-92 and Ba-141 in this case) that are more stable. This phenomenon is what nuclear power and weapons depend on. Depending on the element and the associated isotope, these configurations can have varying “half-lives” (the time it takes for half of the atoms in a collection to “come apart” or decay into different, more stable isotopes). The reason for this phenomenon is that for elements with nuclei larger than iron, the strong and weak nuclear forces begin to “fail” in their ability to keep the nucleus together as more and more protons aggregate into the nucleus. A contributing factor is that elements larger than iron contain so many electrons that the nucleus struggles to keep them close to the atomic core. This reduces the binding effect of the electrons and thus adds to the destabilization of larger atoms.

Understanding this factor is important because we have to be careful when generalizing matter. It is incorrect to say that all atoms are stable and will not degrade, even the atoms of lighter elements. Some isotopes are very unstable and exist for only fractions of seconds. Other isotopes are very stable and take much longer (on average) to degrade. Still others are so stable that, to date, we have been unable to measure decay rates or determine half-lives for them. Then again, we’ve only been investigating atomic decay for a relatively short time. In sum, when any atom degrades, it is a consequence of the same phenomena: the balance of strong, weak, and electromagnetic forces that hold a nucleus together is lost, resulting in a repulsive force that ejects particles away from the atom. Whether we have observed, described or understand it, a probability exists that any atom may decay.

The periodic table of elements describes the configurations of atoms. It provides a structured basis for understanding the trends and behaviors associated with atoms. The periodic table is arranged so that anyone who understands the basic properties that make up an element (atom) can predict with some degree of certainty the behavior of that element (see figure next page). This predictability is based on an understanding of what changes when an atom adds an electron, proton or neutron.

As one marches across the periodic table (beginning in the top left corner) the elements add more and more protons to their nuclei, meaning they also have more and more electrons surrounding those nuclei. The electrons that surround the nucleus of an atom occupy special regions called orbitals. Each orbital can contain a limited number of electrons in it. There are four different types of orbitals, named S, P, D, and F. The number of electrons they can hold, as well as their sizes and shapes, distinguishes them. As more electrons are added to an atom, this increases the amounts of energy – called energy levels – that the electrons of an atom hold. Electrons will occupy energy levels of the same orbital until the orbital can no longer fit any additional electrons. The next electron added to the atom then occupies a different orbital at the next highest energy level. The rows of the periodic table order the elements by the energy levels that reflect the most stable regions for the electrons to arrange themselves around the atom. The stable configurations minimize the repulsive forces of other electrons, and maximize attractive forces with the positive charge of the nucleus. The shape of the orbitals describes the lo-

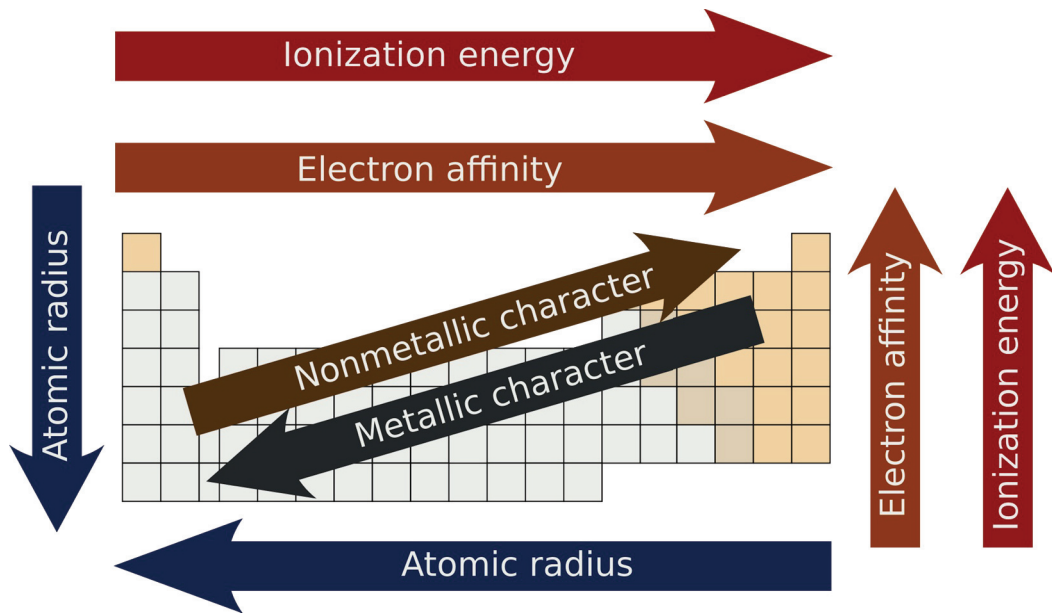

Diagram of the Various Periodic Trends.  
Periodic Trends/Mirek2

cations and distances at which we expect to find an electron most often (on average). The more electrons there are in an atom, the more energy levels are involved, and the higher-energy electrons are, on average, farther from the nucleus. Thus the reactivity (i.e., behavior) of an atom is reflected by the stability of the particular atomic arrangement of the atoms protons, neutrons, and electrons.

### Ions

For an atom of a given element, the highest energy level of the orbital and the last electron occupies determines its *valence* orbital. The electrons that occupy these outer orbital shells are called valence electrons. Valence electrons are the most important electrons when it comes to chemical reactivity and thus classical corrosion events (e.g., ionic effects) occur when substances exchange possession of valence electrons. Even though atoms are electrically neutral when they have the same number of electrons as protons, they are more stable when all of the valence energy levels are full. The forces keeping valence electrons attached to an atom are small enough that they can leave an electromagnetically balanced atom to occupy another atom that has a more favorable empty valence energy level. The principles behind this are described by thermodynamics and quantum mechanics. Orbitals that don't have any empty energy levels are said to be "fully occupied" and the electrons within those orbitals, called "core electrons," do not participate in any chemical reactions: the reason the noble gases are so non-reactive is because their outer electron shells are full. The trends on the periodic table are a reflection of the desire for atoms to obtain the most stable, electron configuration. Thus, understanding what controls the behavior of valence electrons is critical to understanding the *chemical* behavior of atoms, molecules, and as we scale up, materials.

Forming and dissolving of table salt

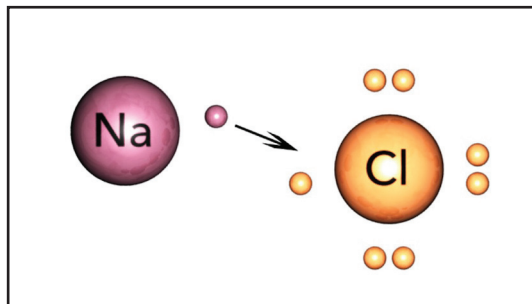

1. Sodium, which has one extra electron from an ideal energy configuration, collides with chlorine, which needs one more electron to have an ideal energy configuration.

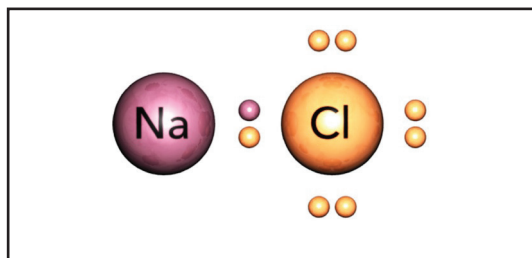

2. Upon collision, the sodium atom begins to share its extra electron with the chlorine atom.

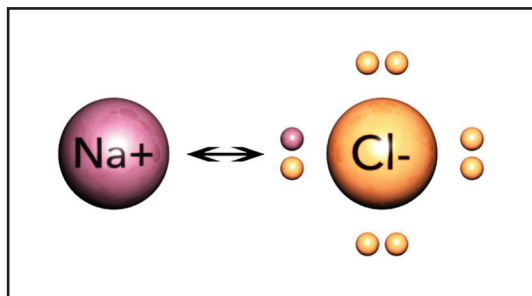

3. If dissolved in an aqueous solution, the sodium gives up its extra electron to the chlorine atom, forming sodium (+) and chlorine (-) ions.

Image credit: Alex Taliesen

When an atom either gains or loses an electron, its charge becomes imbalanced and we call it an *ion*. The relative tendency for an atom to take on an extra electron can be calculated as electronegativity. The closer an atom is to having its valence electron shell full, the more electronegative that atom is because obtaining an extra electron puts it one electron closer to a more stable configuration. Additionally, the smaller an atom is, the more electronegative it is because smaller atoms have a stronger “nuclear pull” on their electrons. If two atoms are close to each other and an electron is placed in between them, the one that is more electronegative will tend to capture that free electron. Of all the trends the periodic table helps us understand, the trend of electronegativity is the most important when it comes to understanding chemical reactivity.

Ions tend to form when elements “dissolve” in a solvent.<sup>3</sup> The most common solvent is water; for example, when common table salt (NaCl) is added to water, the Na (sodium) and Cl (chlorine) tend to separate into positive and negative ions, respectively. The reason that common table salt dissolves in water into ions (sodium ion, Na<sup>+</sup> and chlorine ion,

3. A solvent is a fluid used to dissolve another substance (typically called the solute).

Cl-) is because the loss of an electron from sodium gives it the electron configuration of a noble gas and the gain of an electron from chlorine gives it the electron configuration of a noble gas. By splitting as they do, ions fill their valence shells. Understanding this trend explains why we see the presence of certain stable ions. The difference between ions and noble gas atoms is that ions have unbalanced charge – which makes ions more chemically reactive than noble gases. All simple ions that exist in nature are a reflection of the general trends we see on the periodic table, and reflect a more stable arrangement of their electrons than existed when the atom was neutral.

The figure on page 38 describes what happens when sodium and chlorine combine to form table salt (middle picture in the figure). The bottom picture shows what happens when table salt dissolves in water: the sodium separates from the chlorine, but in the process leaves an electron with the chlorine. Both ions now have more stable electron configurations and as long as the water molecules keep them sufficiently separated, they do not recombine. If the water evaporates, the positive and negative ions will be attracted to each other and reform table salt.<sup>4</sup>

The term oxidation describes the process of an atom/ion giving up an electron to an atom of higher electronegativity (typically oxygen) and is a common process that occurs in various metals. Just as with ionization in general, a metal oxidizes because the metal's valence electrons are more stable on the atoms of the oxidizing agent. The atom that gains the electron, in most cases oxygen, is said to undergo reduction (see figure page 40). When iron reacts with oxygen, iron oxide (FeO<sub>2</sub>), commonly known as rust, forms. At the molecular level, FeO<sub>2</sub> is more stable – but at the macroscopic level on which we experience it – rust is annoying.

## Molecules

Molecules are slightly larger in scale than atoms and consist of two or more atoms locked into a particular geometry through electrostatic interactions. The forces that hold these atoms into their geometries are called bonds and these bonds give molecules their structure. The structures of molecules help give rise to new properties that individual atoms do not possess.

Bonds, like orbitals, come in different, unique types. As stated before, all bonds are electrostatic in nature and represent an interaction between two atoms. No matter what type, a bond exists because the two atoms involved experience an attractive force based on charge separation<sup>5</sup> (a phenomenon commonly observed in “static electricity”). These charge separations can be transient or permanent.

The ionic bond is the strongest type of bond. These bonds occur when ions exist in close enough proximity to become strongly attracted to each other (i.e., form a bond). Covalent bonds are strong, but weaker than ionic bonds, and involve the sharing of electrons between two atoms. These bonds occur between two atoms that have similar

4. Christe Ann McMenemy, *Natural Science- Year II, Unit 37: Lavoisier and Chemical Reactions*, Scholars Online Course, [http://www.dorthonion.com/drcmcm/NATURAL\\_SCIENCE2/Lessons/Lectures/wk37\\_Lavoisier\\_Molecules/NSS.php](http://www.dorthonion.com/drcmcm/NATURAL_SCIENCE2/Lessons/Lectures/wk37_Lavoisier_Molecules/NSS.php).
5. Charge separation is the result of building space between particles of opposite charges, such as ions.

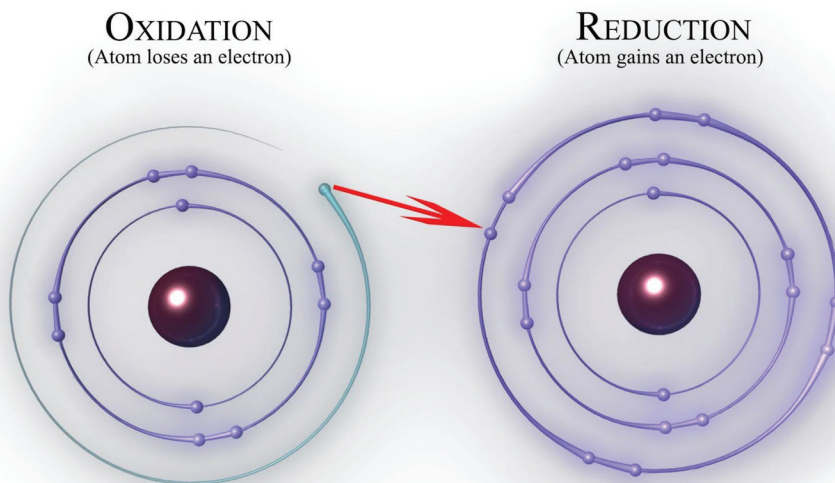

Oxidation and Reduction/Alex Taliesen

electronegativity properties and the sharing of electrons allows them to “feel” like they have filled their valence shells. Metallic bonds are weaker than both ionic and covalent bonds and involve the delocalization of electrons among many metallic atoms aggregated together. There are also secondary bonds, such as dipole or van der Waals interactions, that involve transient changes in a molecule's or atom's charge polarity. These are much weaker than ionic, covalent, or metallic bonds, but collectively can have a tremendous influence on a material's structure and properties.

The properties of bonds are the basis for chemical reactions. These reactions are, for the most part, well understood. Depending on the particular electronegativity properties of an atom it will tend to engage other atoms, ions, or molecules through ionic, covalent, metallic or other secondary bonding schemes. Classical corrosion is focused on understanding why atoms, ions, and molecules exchange electrons to form new

**Classical corrosion is focused on understanding why atoms, ions, and molecules exchange electrons to form new bonds and take on new structures.**

bonds and take on new structures. Although the atoms involved in chemical reactions become more stable, these reactions lead to changes in the atomic or molecular geometries. The properties of a particular material depend on the atomic and molecular structures that make it up. Accordingly, chemical reactions that change these structures are degradation events that lead to changes in the material's properties. When iron is exposed to water it loses some of its valence electrons to oxygen. This forces iron to stop bonding with the other iron atoms around it and this of

course effects the structure of the other iron atoms. Thus, while the formation of iron oxide (i.e., rust) might be more stable, it weakens the iron metal because it causes degradation of the underlying metallic structure. This is why classical corrosion is concerned mainly with the chemical reactions of ions and molecular level effects. With a basic understanding of atoms, ions and molecules as a basis, let's move on to the various roles they play in materials degradation.



## THE SCIENCE OF DEGRADATION

Moving from a summary of the foundational concepts of atoms and chemistry, we need to examine the specific processes that cause degradation. It is clear that there are materials that degrade through mechanisms different than those traditionally associated with classical chemical corrosion. In this section, we categorize the different processes that can disrupt the properties of materials, resulting in degradation via chemical and non-chemical reaction mechanisms. These categories include low-energy collisions, high-energy collisions, the effects of field forces, and spontaneous degradation, also known as radioactive decay.

### Low-Energy Collisions

Traditional chemical (classical) corrosion is caused by what we call low-energy collisions. These collisions are the common chemical reactions that occur between atoms, ions, and molecules (see the figure to the right). Oxidation-reduction reactions occur because atoms and molecules collide with enough energy to exchange electrons, but not with enough energy to alter



Chemical reaction/Aushulz

their nuclear properties. Additionally, lower-energy light photons, such as those in the visible or infrared spectra, can play a role in these chemical reactions. Photons can also collide with matter, but these interactions only have enough energy to excite valence electrons to a higher energy state. The collisions do not transfer enough energy to eject a valence electron. However, when these electrons occupy a higher energy level, the atom itself is inherently less stable and is thus potentially more reactive. Low-energy collisions cause atoms, ions, or molecules to exchange electrons.

As stated, low-energy collisions are the primary mechanism of classical corrosion. We describe it here only to provide a context for addressing the differences between classical corrosion and AEC. AEC occurs due to high-energy collisions, field forces, and spontaneous decay – all of which act on an atom's nucleus (the nuclear level).

### High-Energy Collisions

When matter travels at extremely high velocities and collides with other matter, it can cause changes to the nuclear properties of that matter. Due to the high energy associated with these collisions, the participating particles can overcome the electronic repulsive forces caused when the electron clouds get too close, and thus penetrate to the nucleus of an atom. This is the fundamental difference between nuclear and chemical reactions: nuclear reactions involve smashing into the nucleus and chemical reactions involve smashing into electron orbitals. When an event result causes changes to the nucleus of an atom in a material, we call it atomic effects corrosion (AEC). Subatomic

particles, such as a proton or neutron, can be ejected from the nucleus of an atom when a gamma photon (light packet) carrying large amounts of energy collides with the atom. In its extreme form, mechanisms such as this lead to what is referred to as "splitting the atom." Fast neutrons or other particulate radiation, such as that found in a cosmic ray, can smash into the atoms of a material like a bowling ball wrecking pins (see figure to the right). These high-energy collisions often cause changes to the atomic properties of atoms within a material, as well as forcibly displacing them from their previous location

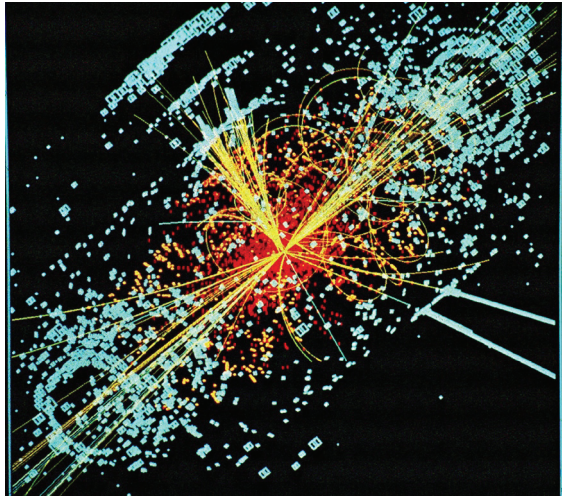

CMS: Simulated Higgs to two jets and two electrons. Image creator : Lucas Taylor CERN

within a material's atomic or molecular structure. These are the degradation events we typically associate with AEC. High-energy collisions that destroy chemical bonds and/or cause the ejection of valence electrons from atoms (i.e., another mechanism for ionization) are more associated with classical corrosion as these are essentially changes in the electronic configurations of atoms.

### *Field Forces*

In addition to interactions with particles, atoms, and photons, there are environments that can produce strong electromagnetic fields (i.e., force particles) that can attract or repel matter in ways to cause serious damage to the structure and properties of a material. There are natural and artificial sources of these strong electromagnetic fields. Artificial sources arise from a wide range of phenomena (see figure to the right), from small electromagnetic fields around power lines and within electronics that cause electromigration,



Lightning/Timothy Kirkpatrick

to large fields like those produced in medical instruments such as nuclear magnetic resonance imagers (MRI). Such large fields can cause changes in atomic configurations at the nuclear and electron shell levels. Field forces, therefore, can both cause AEC and influence the rate at which classical corrosion occurs.

### Spontaneous Degradation

Spontaneous degradation occurs when an unstable nucleus decays and emits radiation; in most cases, at the same time its nucleus splits into two or more smaller atomic nuclei. Spontaneous degradation is a stochastic, or random process in the sense that we cannot predict when a particular atom is going to decay. The most familiar type of spontaneous degradation process is radioactive decay. Spontaneous degradation processes are a consequence of the second law of thermodynamics, which describes the process known as entropy. The concept of entropy describes

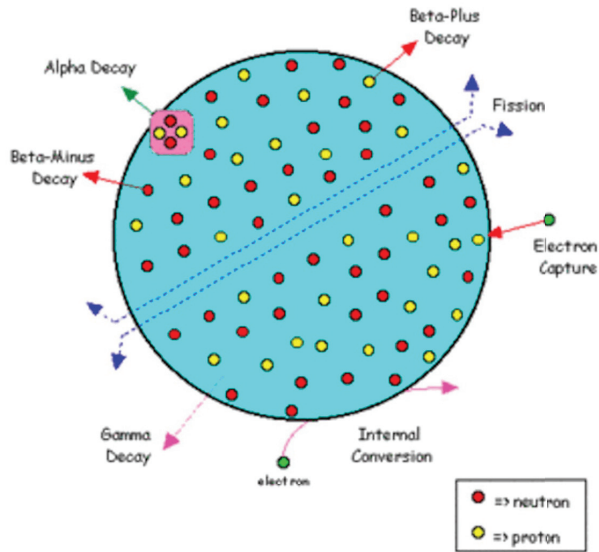

A hypothetical nucleus which can undergo many forms of radioactive decay/Kieran Maher

the natural tendency of matter to fall apart, resulting in more disorder in the universe. It is a misconception that only radioactive atoms and molecules are susceptible to spontaneous decay. Any atom within a material can fall apart, and thus any material can degrade in this way at any moment in time. For most non-radioactive atoms, however, spontaneous degradation is such a low-probability event that at it has no real effect on the macroscopic scale. Aside from atoms falling apart, atomic and molecular structures can degrade due to entropy caused by phenomena like diffusion. Entropy guarantees that anything with order, be it an atom or a tank, has a chance to spontaneously lose that order.

### Degradation Mechanisms: Summary

In summary, the four broad categories that describe the various mechanisms by which materials can degrade are summarized as follows.

<p><b>Low-Energy Collisions</b></p> <ul style="list-style-type: none"> <li>• Chemical reactions</li> <li>• Oxidation-Reduction</li> <li>• Electron excitation</li> </ul>	<p><b>High-Energy Collisions</b></p> <ul style="list-style-type: none"> <li>• Particulate radiation</li> <li>• Electromagnetic radiation</li> </ul>
<p><b>Spontaneous Degradation</b></p> <ul style="list-style-type: none"> <li>• Radioactive decay</li> <li>• Spontaneous bond breaks</li> </ul>	<p><b>Field Forces</b></p> <ul style="list-style-type: none"> <li>• Electromagnetic fields</li> <li>• Gravitational fields</li> </ul>

Of these categories, classical corrosion studies only address specific types of low-energy collisions, such as those associated with oxidation-reduction reactions, and some associated with field forces (e.g., electromigration) and spontaneous decay (e.g., electron diffusion). What is clear is that there are other phenomena and processes that can cause materials to degrade. What is less well known is: when is it important, and what can we do to prevent it from causing unwanted degradation?

To highlight the importance of these distinctions among types of degradation, let's return to the dilemma associated with microchips described above: manufacturing microchips. We are developing microchips with increasing numbers of nanometer-sized components, yet we counter that advantage by having to design redundancies into those chips. ***If we can understand the specific mechanisms of degradation and their implications on modern systems, then as technology advances, we may be able to overcome their effects and no longer need to resort to building in numerous redundancies.*** This is the motivation behind addressing AEC as a degradation/corrosion mechanism – and it is why this non-classical degradation phenomenology is important to understand so as to overcome materials degradation and promote improved material sustainment policies.

Many materials that are involved in discussions of classical corrosion do not fall into the AEC category because most materials' function depends on an atomic/molecular structure composed of an astronomical number of atoms. A change in one atom's atomic properties is not going to impact the overall functionality of the material. Yet, as technology advances, AEC is likely to become more important in materials where a few AEC events *will* degrade the material. Now, let's address the different types of AEC and their potential impacts.

## ATOMIC EFFECTS CORROSION IMPLICATIONS

In the remainder of this chapter, we move beyond the scientific description into the practical considerations of AEC impacts on – and their importance to – a variety of DoD and other systems. We do not mean to suggest in this section that any part of the spectrum of corrosion/degradation has been neglected. Indeed, much physics and chemistry research in the area of atomic effects corrosion has been completed. However, AEC and other corrosion mechanisms have, to date, been largely separated into different fields, with little collaboration or cross-fertilization. We argue that there are reasons to increase collaboration in the scientific investigation of materials degradation and

**If we can understand the specific mechanisms of degradation and their implications on modern systems, then as technology advances, we may be able to overcome their effects and no longer need to resort to building in numerous redundancies.**

material sustainment. Further, we argue that even if the mechanisms and effects are not causing significant problems today, it is likely that (a) their importance will increase in the future as technology develops, and (b) identifying new ways to prevent materials degradation offers opportunities to develop more reliable, longer life systems. Chapter 3 provides recommendations in the areas of DoD interests, and the associated research areas, along with policy and strategy development. Let us now continue with the importance of AEC.

## THE INCREASING IMPORTANCE OF AEC

As technology and applications develop, specialized systems will operate in new environments, and consequently new material sustainment requirements will be identified. By anticipating problems that could emerge in the future, we can avoid being reactive to materials degradation problems, and instead design new applications beforehand, with the supporting science and policy associated with material sustainment capabilities. The emerging AEC issues arise in part due to the scale at which systems are constructed. While classical corrosion science focuses on the transfer of ions and electrons and the associated chemistry that affects materials at the molecular level, radiation and nuclear effects cause degradation from atoms emitting subatomic particles or radiation. These atomic effects are in the realm of nuclear physics. As a result, as our systems become more sophisticated, atomic effects cause various problems within varying environments. When (not if) the atomic effects start affecting the functionality of our systems, we will need to find different solutions not solely based on classical corrosion chemistry. We expect impacts in the areas of microelectronics, nuclear weapons, nuclear waste storage, materials in radioactive environments, and materials in space.

In microelectronics, as spacing or “feature sizes” between processors or components get smaller (see figure below), the effects of quantum events and other atomic processes become more impactful, and the consequences of even single events might have long-term effects on system reliabilities. The impact of cumulative nuclear effects has not been the subject of prominent microelectronics research because to date, it has not yet resulted in noticeably harmful degradation. This will soon no longer be the case.

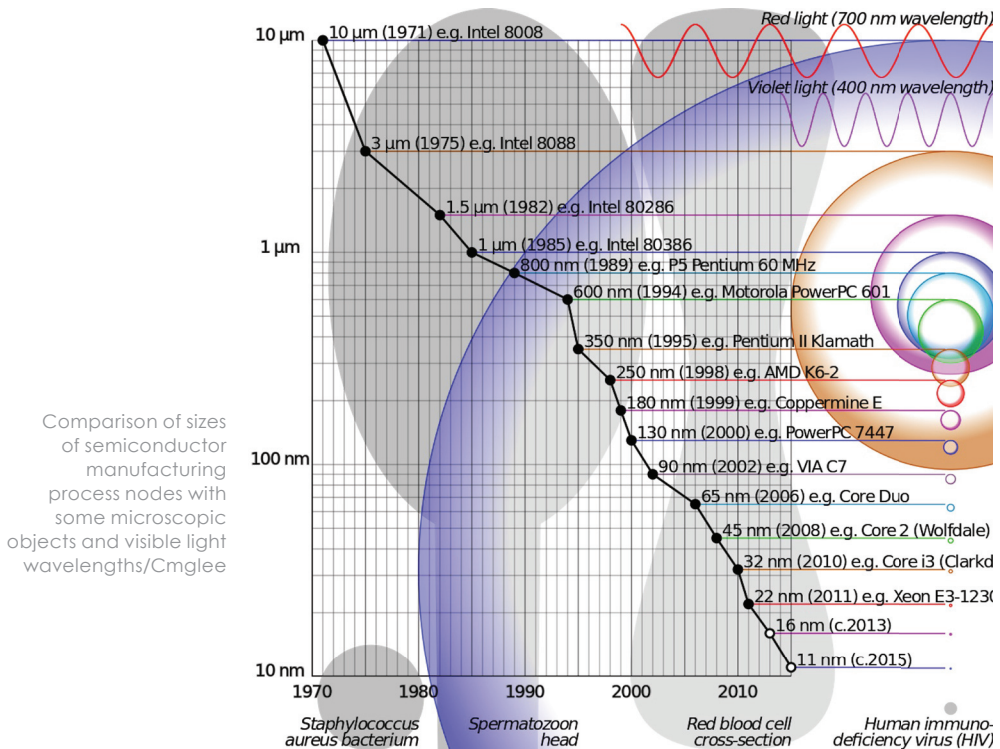

A great deal of research has been performed on “single event effects” (SEEs), which can cause microelectronics to experience a temporary change that causes a digital error, or permanent changes that can damage circuit components. As of 2015, microelectronic feature sizes will soon descend to single digit nanometer ranges. Field densities will also increase, which means that AEC is likely to become important in microprocessors and sensor systems in the very near future.

The field of modeling microelectronics reliability is well established, and has progressed from empirical models to physics-based analysis of component reliabilities.<sup>6,7</sup> Some of the principle effects modeled that lead to microelectronic degradation include electromigration, hot carrier injection, lattice degradation, dielectric breakdown, and negative

**Microelectronics is the main forum where we currently encounter nanotechnology (“nanotech”).**

bias temperature instability (see appendix 1 for more detailed descriptions of some of these effects). While these models take into account some basic quantum effects, they are based on a macroscopic perspective and do not necessarily scale down to feature sizes that are only a few tens of atoms in width. Many challenges remain, including improving modeling and validation of atomic-level effects, and accounting for the dependencies of voltage and temperature.

Microelectronics is the main forum where we currently encounter nanotechnology (“nanotech”). The future will bring nanotech robots, structural materials involving nanotech, nanosensors, and nanobiologics. The effects of degradation of individual atoms due to AEC will become important in these and other, as yet unforeseen, areas.

Atomic effects corrosion is already an important consideration to the U.S. nuclear stockpile. As our nuclear weapons age, it becomes a graver issue, in terms of the costs for maintenance and the eventual need for new designs. Furthermore, our nation does not currently test nuclear weapons, so a new design would have to be deemed reliable, and monitored, through “virtual validation” (i.e., by science based modeling instead of

**As our nuclear weapons age, AEC becomes a graver issue, in terms of the costs for maintenance and the eventual need for new designs.**

direct empirical testing). Without testing, we cannot collect new empirical data, meaning it is increasingly important to understand the science in depth in order to build adequate validation models. Accordingly, a detailed understanding of the degradation processes, including those due to nuclear effects in proximity to various radioactive elements, is critical.

6. Joseph B. Bernstein and Mark White, “Microelectronics Reliability: Physics-of-Failure Based Modeling and Lifetime Evaluation,” *National Aeronautics and Space Administration*, February 2008, <http://trs-new.jpl.nasa.gov/dspace/bitstream/2014/40791/1/08-05.pdf>.
7. Mark Lapedus, “Will 7nm and 5nm Really Happen?” *Semiconductor Engineering*, July 14, 2014, <http://semiengineering.com/will-7nm-and-5nm-really-happen-2/>.

The medium and long-term storage of radioactive waste also continues to be a national issue. Although the topic has been heavily studied, there is still no consensus on the best policy for long-term disposition of such materials. Whether from new weapons programs or new atomic energy production plants, the long-term storage of waste, and the effects of waste material and the containers that store them degrading over time, remain important questions for both DoD and society.

Radioactivity and nuclear events pose degradation hazards in nuclear power plants. For example, control electronics must be protected from radiation in nuclear power plants. Failure to do so could result in sensor failures and in ability to properly characterize and respond to nuclear reactor changes in states. Radiolysis of water is also a serious concern for nuclear plants. Radiolysis is the dissociation of molecules – a chemical process – caused by nuclear radiation. The radiation basically breaks chemical bonds in molecules, separating them into chemically reactive pieces that readily react with their surroundings. This is an example of a process caused by AEC that results in classical corrosion. A coordinated research program focused on both nuclear physics and chemistry may offer improved solutions to this compound degradation process.

**A coordinated research program may offer improved solutions to compound degradation.**

Finally, activities in outer space expose systems (and humans) to radiation and environments that are outside of the shielding protection of our planet's magnetic field and atmosphere. Interest in mining asteroids and exploiting other celestial bodies for resources will almost certainly lead to expanding our use of orbital assets for benefits on Earth. We have a lot of experience with assets in space, however, degradation processes in systems and people in space will become more significant as our use of space expands and as the microelectronics and other systems that are sent into space become more miniaturized.

While the areas of concern for AEC may seem esoteric, these are areas of interest for the DoD, and in the future they are likely to be more impactful in terms of cost and national needs. Whether addressing the lifespan of microelectronics, the reliability of our nuclear deterrent, or the longevity of power plants fueled by nuclear materials, it is in our national interests to do the research, develop the science and thus have the knowledge and means to prevent and/or mitigate degradation by AEC mechanisms.

**... it is in our national interests to do the research, develop the science and thus have the knowledge and means to prevent and/or mitigate degradation by AEC mechanisms.**

## CURRENT RESEARCH IN AEC FIELDS

There is a large and vibrant research enterprise in various specific aspects of AEC, and some of that research is classified. Furthermore, the research in this area is largely separate from other branches of corrosion and degradation research. This section surveys what is known about AEC, based on current and ongoing research, at the unclassified level.

**We briefly discuss current research in each of the following areas<sup>8</sup>:**

- 1 Reliability of weapons due to materials degradation in nuclear environments.
- 2 Medium and long-term containment of nuclear waste materials from nuclear power plants and from weapons development.
- 3 Degradation of components in current and future nuclear power plant environments.
- 4 Degradation of materials in outer space intended for long service lives.
- 5 Microelectronics.

While various organizations are addressing traditional corrosion issues, we propose that there is a need to develop a coordinated, collaborative research environment to address the multidimensional issues associated with AEC, as well as AEC leading to classical corrosion. The goal of the coordinated research program we recommend in the next chapter is to ensure that the field of material sustainment is proactive in responding to advancing technology and its application in different environments, as opposed to reacting to failures and sustainment surprises that show up as effects become more serious.

## NUCLEAR WEAPONS

Nuclear weapon systems, a crucial piece of U.S. national defense, are among the most complex systems devised by mankind. Creating fusion and fission reactions are simple, compared to the task of creating systems that constitute safe and reliable weapons that can be secured and maintained for years. All modern nuclear weapons include complex microelectronics systems, other materials, and radioactive elements that change over time. All of these components are subject to degradation, and thus require maintenance. The weapons in the U.S. nuclear stockpile were designed for 20 to 25 year life spans;<sup>9</sup> but some are now over 40 years old.

---

8. It may strike the reader that the importance of many of these areas has been mentioned in the previous section.

9. Brian Fishbine, "Shelf Life Guaranteed. Extending the Life of Nuclear Weapons," *Los Alamos National Laboratory*, 2007, [https://www.lanl.gov/quarterly/q\\_w03/shelf\\_life.shtml](https://www.lanl.gov/quarterly/q_w03/shelf_life.shtml).



The DoE “Stockpile Stewardship Program” is executed primarily by the DOE National Laboratories and administered by the National Nuclear Security Administration (NNSA).<sup>10</sup> The purpose of the program is to understand and analyze the reliability of the nuclear stockpile, and to ensure said reliability through analysis and experiments. The program was developed in response to the 1992 decision that the United States would cease all nuclear detonations, including underground nuclear testing. The NNSA Stockpile Stewardship program includes the “Life Extension Programs” (LEP) for inspecting, reconditioning, and maintain our nuclear stockpile. Independent review of these efforts is conducted regularly; for example, the JASONS (a scientific advisory group named after Jason, the Argonaut of Greek mythology) regularly review components of the LEP for technical and policy soundness.<sup>11</sup> The science that has been developed to understand stockpile degradation is extensive and complex. The scientists performing these analyses are dedicated to achieving the stewardship and maintenance of viability, and to understanding in detail the modalities that cause degradations.

**We can, nonetheless, provide a few unclassified observations:**

- There have been open reports of defects and degradation within nuclear weapons on several instances throughout their history.
- Tritium triggers must be replaced regularly, but the United States ceased production of tritium in 1988.<sup>12</sup> Since then, replacements have been made with recycled tritium.<sup>13</sup>
- In addition to nuclear decay, nuclear pits (the fissile material) can corrode. Plutonium pits degrade when exposed to humidity, and other materials and alloys employed in the fissile pit are subject to normal corrosion.
- Radioactive materials can catalyze the corrosion of surrounding materials.
- The corrosion of core material can result in the deformation of the nuclear pit, which can rupture the storage container.
- Radiation from the fissile material within the device can cause damage to surrounding components.
- Microelectronics in devices with nuclear material can degrade due to the highly radioactive environment.

10. “Maintaining the Stockpile,” *National Nuclear Security Administration*, Accessed 21 Sept 2015, <http://nnsa.energy.gov/ourmission/maintainingthestockpile>.

11. JASON Program Office, “JASON B61 Life Extension Program Nuclear Scope Review,” *The MITRE Corporation* (La Jolla, California: August 9, 2012), <http://fas.org/irp/agency/dod/jason/b61-lep.pdf>.

12. Detlof von Winterfeldt, “Choosing a Tritium Supply Technology for Nuclear Weapons: Reflections on a Controversial Decision Analysis,” *Published Articles & Papers*, no. 32 (2009).

13. *Ibid.*

The interactions of radiation with matter are heavily researched. Even so, important questions remain. For example, how confident are we in our modeling capabilities? Assessing confidence levels based on failure trends requires scientific understanding of the state of analysis, but in areas where the science is not fully developed, this assessment can also involve judgments based on the expertise of directors and executives in the convoluted and difficult area of weapons stewardship.

## NUCLEAR POWER FACILITIES

Nuclear reactors (see figure below) consist of relatively few components: reactor core, control rods, heat transport system and nuclear fuel, almost all of which undergo serious degradation due to AEC.<sup>14</sup> The intensity and forms of radiation depend on the fuel type, moderators, and materials used for transporting the thermal energy out of the reactor core. Most nuclear power plants currently use enriched uranium. Some plants also use plutonium, and the interest in developing thorium plants is increasing.

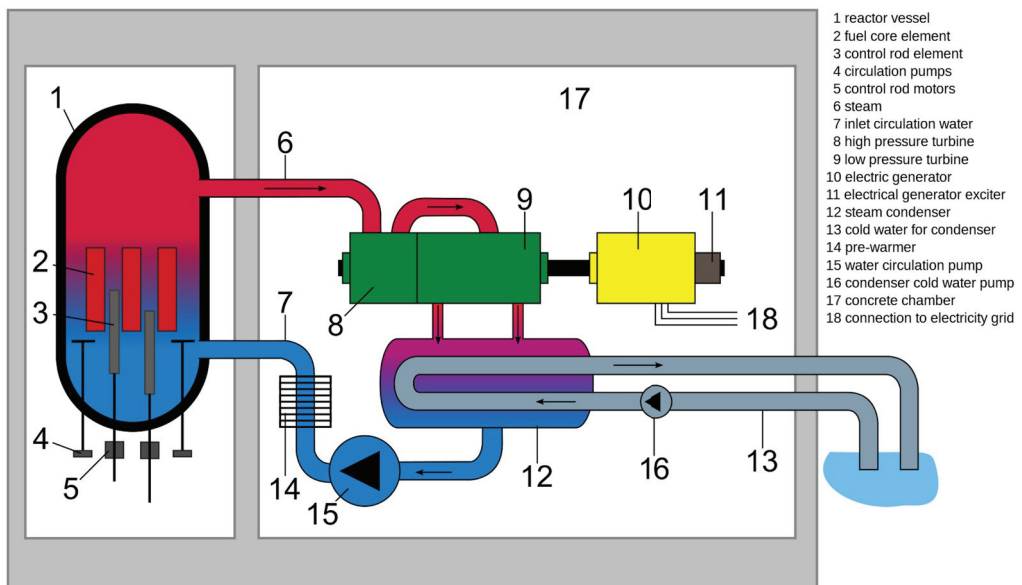

Boiling water reactor system diagram/Image credit: Robert Steffens

The main degradation processes induced by radiation in a nuclear power plant involve stress corrosion cracking and corrosion byproduct buildup.<sup>15</sup> Some of these processes are well understood, having received research attention for many years, particularly due to the known increased likelihood of corrosion in the aqueous (meaning "water containing") environments.<sup>16</sup> High temperatures and pressures exacerbate the development of

14. Oskar Nilsson, "Radiation Induced Corrosion of Steel," (Thesis, Royal Institute of Technology, Sept 2011).

15. Robert Hummel, *Alternative Futures for Corrosion and Degradation Research*, 46.

16. "Fact Sheet on Underground Pipes at Nuclear Reactors," *United States Regulatory Commission*, March 2011, Accessed 21 Sept 2015, <http://www.nrc.gov/reading-rm/doc-collections/fact-sheets/buried-pipes-fs.html>.

corrosion. However, the corrosive effect of decay byproducts is a complex issue that is not as well understood. The radioactive decay of the fuel results in the degradation of metals and materials in the vicinity of the core.<sup>17</sup> The nature of a material itself may be altered by exposure to radioactivity.<sup>18</sup> Research on the impact of radiation on the metals comprising the heat transport systems in nuclear power plants, in particular in light water reactors with an aqueous environment,<sup>19</sup> has determined that nuclear activity not only impacts the rate of corrosion, but also the deposition of byproducts on the metal surfaces and these byproducts must be removed.<sup>20</sup>

Thorium fueled reactors have been touted as cleaner, safer reactors. They may become more prevalent in the future, but as thorium reactors come on line, the ways in which they cause corrosion will need to be studied to determine and overcome the effects.

The corrosion rate of components in a nuclear power plant generally increases with dosage of radiation, but other conditions such as temperature and concentration of oxygen also impact the problem.<sup>21</sup> Corrosion from ionizing radiation, for example, is enhanced by elevated temperatures as well as other factors.<sup>22</sup> Stress corrosion cracking is a particular concern due to the physical pressures that the surrounding materials place on the pipes and containers. The impact of radiation on carbon and stainless steel has been studied for decades, and when exposed to even a small amount of water, corrosion is accelerated by radiation due to radiolysis.

Degradation processes also affect the microelectronics in a nuclear power plant, which must be able to withstand continuous exposure to a relatively highly radiation environment. The functionality of microelectronic controls is also critical in the event of a melt-down, and so they must also be able to withstand the potentially extreme amounts of radiation such a scenario entails. As a result, the microelectronics within current nuclear power plants are hardened against radiation and in some cases, able to survive levels of radiation hundreds of thousands of times greater than what a human can survive.<sup>23</sup> Due to the additional engineering demands, radiation hardened devices are often two to four generations behind commercial electronics. As commercial designs advance, even if power plant microelectronics are generations behind, we need to understand the effects of AEC on the increasingly sophisticated microelectronics that will be used in future power plants.

- 
17. C.R.F Azevedo, "A Review of Neutron-Irradiation Hardening of Metallic Components," *Engineering Failure Analysis* 18, no. 8 (2011): 1921- 1942.
  18. C.A. English and J.M. Hyde, "Microstructural Characterization Techniques for the Study of Reactor Pressure Vessel (RPV) Embrittlement," in *Irradiation Embrittlement of Reactor Pressure Vessels* (Oxford, UK: Elsevier Ltd, 2015), 211-294.
  19. Kevin Daub, "A Study of Gamma Radiation Induced Carbon Steel Corrosion," (Ph.D diss., University of Western Ontario, 2012), <http://ir.lib.uwo.ca/cgi/viewcontent.cgi?article=2404&context=etd>.
  20. "Advanced Membrane Degassing Technology for Radiation Source Term Reduction and Corrosion Control in Nuclear Power Plants," *Liqui-Cel*, 2011, Accessed 21 Sept 2015, [http://www.liquicel.com/uploads/documents/TB%2081%20Advanced%20Degassing%20for%20Radiation%20Source%20Term%20Reduction%20in%20Nuclear%20Power%20Plants%2012-11\\_final.pdf](http://www.liquicel.com/uploads/documents/TB%2081%20Advanced%20Degassing%20for%20Radiation%20Source%20Term%20Reduction%20in%20Nuclear%20Power%20Plants%2012-11_final.pdf).
  21. Václav Čuba and Viliam Múčka and Milan Pospíšil, "Radiation Induced Corrosion of Nuclear Fuels and Materials," in *Advances in Nuclear Fuel* (22 Feb 2012).
  22. *Ibid.*
  23. Rachel Courtland, "Radiation Hardening 101: How to Protect Nuclear Reactor Electronics," *IEEE Spectrum*, 22 March 2011, Accessed 18 Sept 2015, <http://spectrum.ieee.org/techtalk/semiconductors/design/radiationhardening-101>.



Nuclear Waste Barrels/ Flickr/Iwan Gabovitch

## NUCLEAR WASTE DISPOSAL

The nuclear enterprise consists of nuclear power plants and suppliers to those plants, nuclear weapons manufacture and maintenance, and research reactors and suppliers of nuclear materials for medicines and other applications. Each of these sources produces waste products (see figure above) that require handling and disposal. Furthermore, each source has previously produced waste that is in short or intermediate term storage awaiting longer-term solutions.

Nuclear power facilities produce three types of waste: high-level waste, mill tailings and low-level waste. This waste is currently stored in water pools at nuclear facilities or in temporary dry surface storage.<sup>24</sup> Some of this fuel has been in storage as long as 30 years, yet a permanent long-term storage site has not been identified.<sup>25</sup>

The waste from nuclear weapons development has been accumulating for decades. More than a hundred sites around the country contain waste products that will need eventual disposal. Furthermore, facilities are needed to cleanse contaminated groundwater.

Much of the study of nuclear waste storage degradation has focused on the impact of ionizing radiation on metals in an effort to find a safe and effective way to store and dis-

---

24. Michiel P.H. Brongers, "Appendix CC," *Nuclear Waste Storage* (CC Technologies Laboratories, INC., Dublin, Ohio), Accessed 04 Sept 2015, [http://www.dnvusa.com/Binaries/nuclearwaste\\_tcm153-378896.pdf](http://www.dnvusa.com/Binaries/nuclearwaste_tcm153-378896.pdf).

25. Matthew L. Wald, "Quarrels Continue Over Repository for Nuclear Waste," *The New York Times*, 27 June 2013, Accessed 14 Sept 2015, <http://www.nytimes.com/2013/06/28/business/energy-environment/quarrels-continue-over-repository-for-nuclear-waste.html>.

pose of nuclear waste long-term. As we have noted, there are a variety of waste types, including “spent fuel” from nuclear power plants, and the byproducts of both power plants and nuclear weapons factories. Spent nuclear fuel and its byproducts can be reprocessed to recover unspent fuel, or to develop new material from certain radioactive waste products such as plutonium. Reprocessing reduces the volume of waste, but nevertheless leaves residual waste that must be handled. Similarly, waste from nuclear weapons development and production includes materials from the enrichment of uranium or the production of plutonium, with large volumes of intermediate products and contaminated materials.

Although long-term storage of nuclear waste has been studied for decades, there is more to learn about the medium and long-term viability of materials for storage of specific radioactive materials. Vitrification (embedding the material in glass) to allow for safe storage for thousands of years is one long-term solution being considered.<sup>26</sup> Long-term proposals carry certain risks, which have also been studied.<sup>27</sup> The science suggests that there is a high level of confidence in the technology for containing the radioactivity of the waste for the time necessary to reduce it to safe levels. Containment of harmful chemicals, however, is less certain for the thousands of years that might be required. This is another example of AEC coupled with classical corrosion, and another impetus for a coordinated research program.

**The current Administration has put forth a radioactive waste management plan for implementation, which calls for the following:<sup>28</sup>**

- Sites, designs, and licenses, to begin operations of a pilot interim storage facility by 2021 with an initial focus on accepting used nuclear fuel from reactor sites that have been shut down;
- Advances toward the siting and licensing of a larger interim storage facility to be available by 2025 that will have sufficient capacity to provide flexibility in the waste management system and allows for acceptance of enough used nuclear fuel to reduce expected government liabilities; and
- Demonstrable progress on the siting and characterization of repository sites to facilitate the availability of a geologic repository by 2048.

While comprehensive and well thought out, the plan depends upon appropriate authorizations from Congress before it can be implemented.<sup>29</sup>

Understanding the role AEC plays in the degradation of storage containers for radioactive waste will lead to better reliability in the strategies implemented to deal with the

26. “Savannah River Site Disposal Facility for Waste Incidental to Reprocessing,” *United States Regulatory Commission*, 21 July 2014, <http://www.nrc.gov/waste/incidental-waste/wir-process/wir-locations/wir-srs.html>.

27. “Storage and Disposal of Spent Fuel and High Level Radioactive Waste,” *International Atomic Energy Agency*, Accessed 14 Sept 2015, [http://www.iaea.org/About/Policy/GC/GC50/GC50InfDocuments/English/gc50inf-3-att5\\_en.pdf](http://www.iaea.org/About/Policy/GC/GC50/GC50InfDocuments/English/gc50inf-3-att5_en.pdf).

28. United States Department of Energy, “Strategy for the Management and Disposal of Used Nuclear Fuel (January 2013),” [http://energy.gov/sites/prod/files/2013%201-15%20Nuclear\\_Waste\\_Report.pdf](http://energy.gov/sites/prod/files/2013%201-15%20Nuclear_Waste_Report.pdf).

29. *Ibid.*

increasing amounts of nuclear waste produced by all U.S. nuclear activities. Designing nuclear waste containers that are resistant to AEC and other types of corrosion is needed to ensure safer long term storage and transport of these materials from the sources that generate them to the storage facilities.

## OUTER SPACE

The region of the atmosphere from approximately 50km above the earth's surface to the edges of outer space experiences much more radiation than regions beyond it (see figure below). This volume includes trapped particles within the Van Allen belts, which are regions of intensely charged particles and radiation that collect in the earth's magnetic fields. Further out, solar winds, consisting of charged and other energetic particles that flow continuously from the sun, contribute to increased radiation (see the figure on page 55). Galactic cosmic rays contribute additional particles and radiation.<sup>30</sup> Dr. de Rooij, head of Materials Technology Section at the European Space Agency, notes that materials in space are subject to "...atomic oxygen, ultraviolet (UV) radiation, ionizing radiation, ultrahigh vacuum (UHV), charged particles, thermal cycles, electromagnetic radiation, micrometeoroids, and man-made orbital debris."<sup>31</sup>

Materials subjected to outer space also must be able to withstand extreme temperature and pressure fluctuations. The impact of these extremes is further exacerbated upon exiting and reentering Earth's atmosphere, where spacecraft are moving fast enough to generate extreme heat from friction with the atmosphere. Due to "...synergistic or separate interactions in this envi-

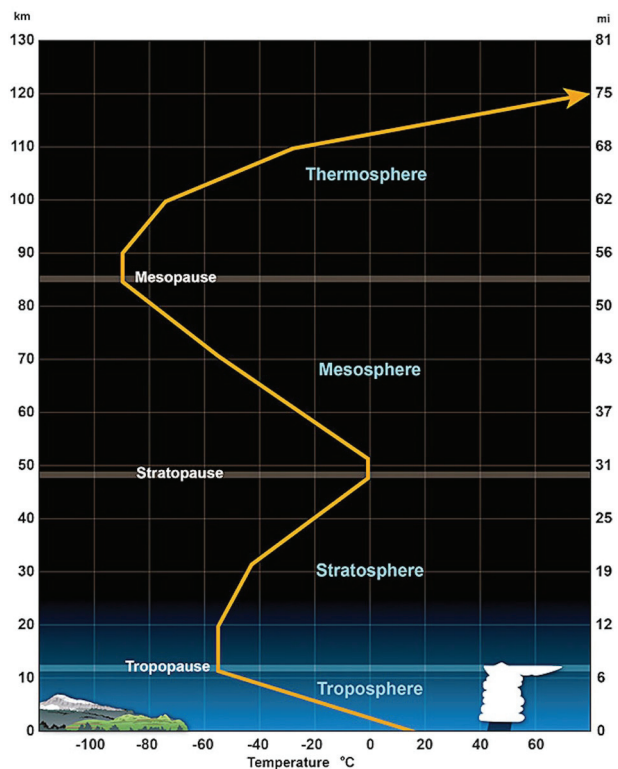

Standardized Temperature Profile/NWS

30. Jan Kenneth Bekkeng, "Radiation Effects on Space Electronics," *University of Oslo, Department of Physics* (Powerpoint presentation), Accessed 18 Sept 2015, <http://www.uio.no/studier/emner/matnat/fys/FYS4220/h11/undervisningsmateriale/forelesninger-vhdl/Radiation%20effects%20on%20space%20electronics.pdf>.
31. A. de Rooij, "Corrosion in Space," *European Space Technology and Research Centre* (Noordwijk, The Netherlands), Accessed 31 August 2015, [http://esmat.esa.int/publications/published\\_papers/corrosion\\_in\\_space.pdf](http://esmat.esa.int/publications/published_papers/corrosion_in_space.pdf).

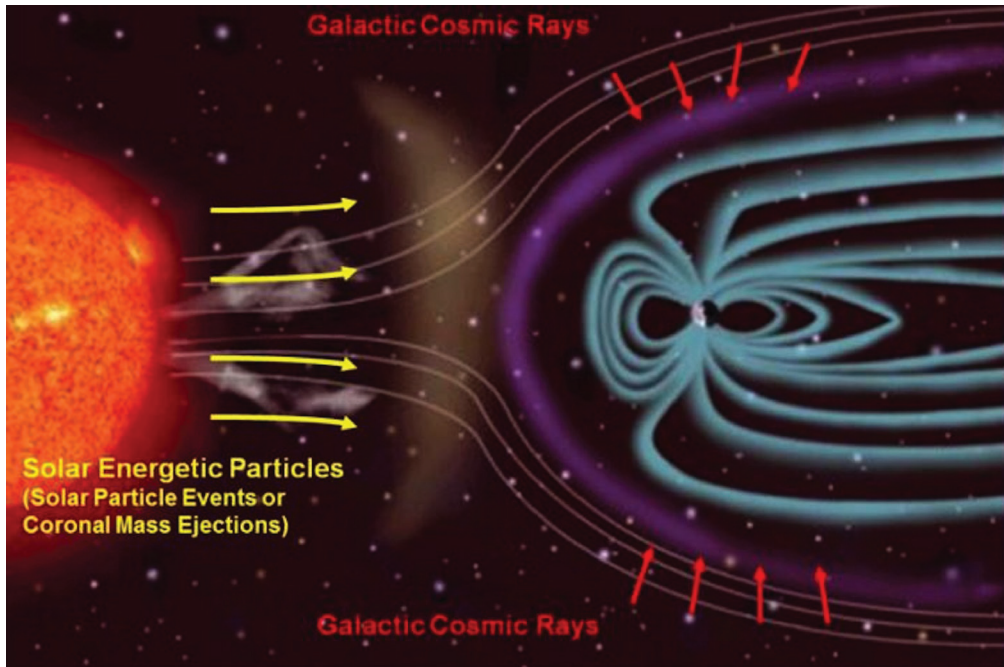

Sources of Ionizing Radiation in Interplanetary Space/Image credit: NASA/JPL-Caltech/SwRI

ronment, the spacecraft materials might suffer corrosion, erosion, structure modification and surface roughening.<sup>32</sup> These effects can degrade their optical, thermal, electrical and mechanical properties.<sup>33</sup>

The effects on humans that go into space can also be considered a degradation problem. A human in space for 10 days experiences about the same amount of radiation as human on Earth does in 10 years. Various radiation-hardening technologies have been implemented in order to shield both the astronauts and the components of the spaceship from radiation, but none of these completely eliminate the increased dosages humans receive in space.

Whether it is humans or spacecraft components, solutions to retard degradation are needed. Humans have been in space for decades and have developed materials, such as polyethylene shielding,<sup>34</sup> that work well at protecting astronauts from high-speed neutrons. Cosmic rays, however, have extremely high energies, and cannot be stopped by any reasonable amount of physical shielding.<sup>35</sup> Other shielding materials such as aluminum sheeting can solve one problem while exacerbating another: the sheeting is in place to deflect primary radiation<sup>36</sup> but produces secondary radiation in the process.

32. *Ibid.*

33. *Ibid.*

34. Mark Shavers, "Radiation Measurements and Shielding Analysis for ISS," *Vienna University of Technology* (Presentation), September 8-10 2014, [http://www.iss-casis.org/files/CASIS\\_RFP\\_2013-3\\_Radiation\\_Measurements\\_and\\_Shielding\\_Analysis\\_for\\_ISS.pdf](http://www.iss-casis.org/files/CASIS_RFP_2013-3_Radiation_Measurements_and_Shielding_Analysis_for_ISS.pdf).

35. "A 'designer material' derived from plastic could help protect astronauts on their way to Mars," *NASA Science News*, 25 Aug 2005, Accessed 28 Aug 2015, [http://science.nasa.gov/science-news/science-at-nasa/2005/25aug\\_plasticspaceships/](http://science.nasa.gov/science-news/science-at-nasa/2005/25aug_plasticspaceships/).

36. Patrick Morgan, "To Hitch a Ride to Mars, Just Flag Down an Asteroid," *Discover Magazine*, 11 Feb 2011, Accessed 22 Sept 2015, <http://blogs.discovermagazine.com/discoblog/2011/02/11/to-hitch-a-ride-to-mars-just-flag-down-an-asteroid/>.

The impact of the irradiative environment on surface materials is particularly important to mitigate degradation to solar cells, which are used to power most systems in space. Photovoltaics (PV) are typically composed of crystalline structures.<sup>37</sup> These structures are coated with substances designed to maintain their integrity.<sup>38</sup> However, as the environment degrades this coating, the efficiency of the solar cell is reduced over time. Other atomic effects on the components also degrade the photovoltaic efficiency over long periods in space. These effects may become even more important in the future if we move forward with space based solar power systems.<sup>39</sup>

In space, a material's tolerance of the wide breadth of temperatures and physical forces it will experience must be considered as well as its ability to withstand cosmic rays, solar wind, and radiation belts.<sup>40</sup> For example, the surface temperature of the International Space Station (ISS) can increase by up to 500 degrees when passing from the earth's shadow into the sun as it orbits the earth.<sup>41</sup> Within spacecraft, heat can accumulate; for example, both the humans and equipment within the ISS produce heat. If there is insufficient air to serve as a medium for the transport and circulation of heat, temperatures could rise enough to cause a dangerous environment for the sensitive electronic equipment on board.

Another classical corrosion mechanism in space, as mentioned at the beginning of this section is atomic oxygen (ATOX). Oxygen usually occurs as pairs of atoms, which is a highly stable molecule, but ATOX, an unpaired oxygen atom, is highly reactive and readily bonds with a wide range of elements and compounds. Corrosion is most likely to occur to surface coatings of spacecraft at altitudes where ATOX is concentrated: between 200 and 700km above the earth.<sup>42</sup> Because ATOX occurs in some of the same regions as the Van Allen belts and solar wind, both AEC and classical corrosion, and coupled effects between the two types of mechanisms, can and do occur.

## AEC IN MICROELECTRONICS

We now turn to an area in which AEC is expected to become more significant in the future, whether in the harsh environments of nuclear systems and space, or simply in the milder, yet far from radiation free, environment of terrestrial Earth. In the *Handbook of Semiconductor Manufacturing Technology*, author Robert Baumann discusses the "effects of Terrestrial Radiation on Integrated Circuits."<sup>43</sup> Similarly, *Principles of Radiation In-*

- 
37. "Chapter 11. Typical Onboard Systems," *Jet Propulsion Laboratory, California Institute of Technology*, Accessed 9 Sept 2015, <http://www2.jpl.nasa.gov/basics/bsf11-3.php>.
  38. "New Technology Prevents Degradation of Silicon PV Modules," *R&D Magazine*, 23 July 2013, Accessed 23 Sept 2015, <http://www.rdmag.com/news/2013/07/new-technology-prevents-degradation-silicon-pv-modules>.
  39. "Space-Based Solar Power," *energy.gov*, 6 March 2014, Accessed 12 Sept 2015, <http://energy.gov/articles/space-based-solar-power>.
  40. Leroy, C. and Pier-Georgio Rancoita, *Principles of Radiation Interaction in Matter and Detection*, World Scientific, © 2012
  41. Sasha Viasasha, "Corrosion on the International Space Station," *Multi Briefs: Exclusive*, 29 April 2014, Accessed 09 Sept 2015, <http://exclusive.multibriefs.com/content/corrosion-on-the-international-space-station/engineering>.
  42. A. de Rooij, "Corrosion in Space," *European Space Technology and Research Centre*, [http://esmat.esa.int/publications/published\\_papers/corrosion\\_in\\_space.pdf](http://esmat.esa.int/publications/published_papers/corrosion_in_space.pdf).
  43. *Handbook of Semiconductor Manufacturing Technology*, ed. Robert Doering Yoshio Nishi (Boca Raton, Florida: Taylor & Francis Group, 2008), Chapter 31.



*teraction in Matter and Detection* covers “radiation environments and damage in silicon semiconductors” and “displacement damage and particle interactions in silicon devices.”<sup>44</sup> These and other works have detailed analyses of the effects of radiation on microelectronics. The impact of radioactivity in any environment can lead to errors and also the degradation of semiconductors over time. These references specifically discuss AEC on older microelectronics with feature sizes in the range of 45-90 nm, 4 to 10 times as large as the state-of-the-art microchips being developed today.<sup>45</sup> In the near future, node sizes are expected to decrease even further to single-digit nm feature sizes. As more sophisticated designs are developed, the issues described in these two works and related analyses are likely to become more pressing.

As feature sizes decrease, and consequently component densities on microchips increase, these mechanisms are likely to become much more important. In this section, we briefly discuss the mechanisms by which AEC can affect microelectronics (see figure page 58). In this section, we merely *introduce* the mechanisms. The mechanisms are well documented, and the reader interested in a greater level of detail can find detailed descriptions of some of these mechanisms in appendix 1, a specific example of an AEC mechanism degrading microelectronics in appendix 2, or for a broader description to any of the available textbooks (such as the two cited in the paragraph above). The issues that remain to be determined include the effects of these mechanisms on microelectronics as feature sizes decrease, and whether or not this will bring about new mechanisms.

**As feature sizes decrease, and consequently component densities on microchips increase, degradation mechanisms are likely to become much more important.**

### Single Event Effects

The primary concern with radiation effects on microelectronics currently relates to “single event effects” (SEEs). There are several types of SEEs, which include single-event upsets (SEUs), “single event latchups” (SEL), “single event burnouts” (SEB), each of which we briefly explain below.

A SEU occurs when a bit within the microcircuit is changed from its correct value. In a memory chip, this can change the stored data. Multi-bit upsets are also possible, wherein a set of bits are changed, but the term simply describes multiple SEUs. For the most part, SEUs are “soft errors,” also known as single event transients (SETs), meaning that the damage is limited to the data error, and that any permanent damage is insignificant and inconsequential.

It is, however, possible for a SEE to cause a “hard error,” wherein some part of the microcircuit is permanently damaged. A “single event latchup” (SEL) can, in some instances,

44. Claude Leroy and Pier-Giorgio Rancoita, *Principles of Radiation Interaction in Matter and Detection* (Singapore: World Scientific Publishing Co., 2009).

45. Reference to SOTA size now.



Kichigin/www.shutterstock.com

cause high currents that damage channels or junctions to cause a hard error to a particular component. Even more detrimental is a “single event burnout” (SEB), which can destroy a device due to a high current in a power transistor causing the device to fail permanently.

SEEs are becoming more significant as geometries continue to get smaller.<sup>46</sup> A change to the stored bit stream that programs a field programmable gate array (FPGA: a programmable microchip) can cause a program error, which can result in a failure to function upon execution. The bottom line is, whether soft or hard errors, radiation-caused events cause degradation of the microelectronic device that goes beyond simple data errors to device destruction.

Most of the consequences of single-event effects are due to ionization tracks from charged particles that are emitted due to a nuclear event within the chip. External radiation instigates these events. SEEs are typically instigated by an AEC mechanism

---

46. “Neutron-Induced Single Event Upset (SEU) FAQ,” *Microsemi*, August 2011, Accessed 31 Aug 2015, [http://www.microsemi.com/document-portal/doc\\_view/130760-neutron-seu-faq](http://www.microsemi.com/document-portal/doc_view/130760-neutron-seu-faq).

called linear energy transfer (LET), which is separated into two categories according to how much energy is deposited in a material: “high-LET” or “low-LET.” In either case, energy is transferred during the AEC event to create a shower of ion charges deposited into the microelectronics material, creating “electron-hole pairs.” In this formation, an electron is ejected from a valence orbital. When this occurs, a positively charged ion, aptly named a “hole,” is left behind. Generally, the electrons are much smaller than thus more mobile than the holes and thus the electrons can move more freely through the circuit. Both high- and low-LET events cause more or more frequent problems as gate sizes become smaller.

SEEs can also cause “FITs.” The reliability of microelectronics is measured in Failures in Time (FIT). One FIT is equivalent to one error (hard or soft) per billion hours of operation. Soft error rates in microchips can vary from a few hundred to many thousands of FITs.<sup>47</sup> At 100,000 FIT, one can expect roughly one error per year of continuous operation. For most consumer applications, this is not a significant problem, especially given that most consumers replace their computers, cell phones and other devices every few years. For DoD applications, on the other hand, this could be problematic, both due to their operating environments and the extended life cycles we expect from military systems. Aircraft flying at an altitude of 30,000 feet or higher are subject to neutron densities hundreds of times higher than at sea level. One can therefore expect FIT rates to increase proportionately. For hard errors, greater scaling is possible as multiple events in the same general area within a microchip compound problems, causing degradation that eventually results in failure.

In most terrestrial, non-nuclear system applications, radiation-induced SEEs may be relatively rare, but they can cause upsets and reliability problems, and these can become more consequential in newer microelectronics with smaller feature sizes. Terrestrial microelectronics associated with nuclear weapons or power plants can experience higher rates of SEEs due to the higher-radiation environments in which they operate, and potentially greater rates of hard errors, including degradation-induced failure.

### *Other Microelectronics Atomic-Level Degradations*

The silicon on which most microelectronics are based is formed in a crystal lattice structure. When manufacturing the chip, various processes are used to create doped silicon<sup>48</sup> that produces desirable electrical properties, and the oxides that provide electrical insulation. The result of these manufacturing processes is that the forces that hold the crystal together are weakened. Near the edges of conducting silicon and insulating oxide, for example, the lattice will naturally be weakened as the crystal changes from one material to another.

---

47. Santosh Kumar, Shalu Argarwal, and Jae Pil Jung, “Soft Error Issue Importance of Low Alpha Solders for Microelectronics Packaging,” *Rev. Adv. Materials Science* 34 (2013): 185-202.

48. “Doping” replaces atoms within the crystal with atoms of another element that either creates extra electrons or extra “holes.” Changing the number of electrons or holes in the material changes the electrical properties of the material, resulting in the designed behaviors of the chip

Normally, the voltages involved in operating microelectronics are small enough that the forces, even in naturally weakened areas such as the silicon/oxide interfaces, hold the crystal together tightly enough. As wire sizes and gates become smaller, the amount of edge material, and thus the significance of weakening due to doping, both become greater. In the same way that molecules of water can drift from the surface of a cup of water into the atmosphere by virtue of the molecules' vibrational energy (i.e., evaporation), it is possible for atoms at the edges of crystal lattices to disassociate from the lattice. The constraining forces in this case are different because the underpinning energy levels are different, but the general effect is reducing the amount of material that makes up the device. Whether due to manufacturing fluctuations or the results of the atomic effects described, when these paths or gates become narrow enough, they can result in areas of increased resistance and, under sufficient conditions, the microelectronics simply "burn up" (much like a fuse burning out) from the induced heat.

Other effects in microelectronics can involve a combination of atomic and macro effects, and lead to gradual degradation that renders the chip less reliable. One such effect occurs in flash memory (which has been used for years in random access memory or "RAM" in computers). As tolerances become tighter with smaller gates in flash memory devices, flash memory "wears out" as cells are repeatedly written and read.<sup>49</sup> The mechanisms involve atomic level changes that occur as charges are moved into and from atomic-size devices within the chip. In short, as microelectronics become more sophisticated, effects that were minor in older chip designs can become more prominent.

### *Microelectronics in Quantum Domains*

As gate sizes descend to single nanometer (nm) sizes (for example, Intel is planning to achieve a commercially viable 7 nm feature size in the near future), radiation may cause undesired quantum effects that can lead to degradation and failure of microcircuits.<sup>50</sup> Background radiation, cosmic rays, radioactive decay of isotopes, and other environmental effects can induce atomic effects that render microelectronic components inoperable, error prone, or cause them to exhibit greater failure rates than were observed in older designs. In the same way that various SEEs cause different kinds of damage, environmental conditions can cause either transient or permanent damage.

Ionization events can happen due to applied electric fields in the normal operation of the microelectronic device. By design, these normally involve just a few volts, and thus the field density is relatively small. However, as devices become smaller, the "short channel effects" (referring to the shorter distances charges must travel as microchip

---

49. Chien, A. and V. Karamcheti, "Moore's Law: The First Ending and a New Beginning," *Computer* 46, no.12 (Dec 2013): 48-53.

50. Jason Mick, "IDF 2013: Intel Shows Plans for 7nm Chips; 22nm LTE Atoms are Shipping," *Daily Tech*, 11 Sept 2013, Accessed 20 Aug 2015, <http://www.dailytech.com/IDF+2013+Intel+Shows+Plans+For+7+nm+Chips+22+nm+LTE+Atoms+are+Shipping/article33354.htm>.

feature sizes become smaller) of applied voltage in nanometer feature sizes can cause “hot carrier injection” (HCI) events, meaning electrons or holes carrying charge through the semiconductor material become more energetic due to the high electric field. HCI events are similar to ionizing radiation events.<sup>51</sup>

When combined, a nuclear event inside a region and a high electric field can be the cause of an ionic breakdown: AEC causing classical corrosion. These events will be particularly prevalent during short duration maximum electric field applications common to modern electronics such as power cycles. As carriers move from “source” to “drain” in multichannel devices, they can develop enough kinetic energy to cause ionization. As trapped charges accumulate, interfaces within the device can break down and threshold voltages can change, affecting the performance of the device.

Degradation caused by external radiation can also be experienced at levels as low as simple background radiation. The severity of a total ionizing dose (TID) of radiation, something perfectly achievable by normal background levels, will increase significantly as electronic devices shrink below the 10nm range. This is because the amount of trapped charged material that is needed to short-circuit insulator material is reduced when the total mass of the individual device is reduced. In this realm, small effects that would normally accumulate over decades might have impact in months or weeks.

In addition to accumulation of charges (static electricity), microelectronics can be damaged by other defects caused by radiation. “Displacement damage” (DD) results in the accumulation of crystal lattice defects due to high-energy radiation exposure. Proton, neutron and electron impacts can displace silicon atoms from their proper crystal lattice locations.<sup>52</sup> Separate from ionizing radiation effects, DD causes changes in the electrical properties of the components, and can result in circuit failure as the electrical properties of the device are changed. More specifically, they cause degradation of gain and leakage current in bipolar transistors. In space, this is particularly important for solar panels because DD reduces the power output of the solar cells. DD can also adversely impact optical detectors and light-emitting diodes (LEDs). Similar devices used in terrestrial applications can also suffer from degradation due to DD. Future technologies are likely to employ miniature optical devices embedded in microelectronics, which will also be subject to degradation due to DD.

- 
51. T. Bentrchia F. Djeflal, M. Meguellati and D. Arar, “New Approach Based on ANFIS Computation to Study the Threshold Voltage Behavior Including Trap Effects for Nanoscale DG MOSFETS,” *World Congress on Engineering 2013 Vol II* (proceedings, World Congress on Engineering, London, U.K., July 3 -5, 2013).
  52. Leroy, C. and Pier-Georgio Rancoita, *Principles of Radiation Interaction in Matter and Detection*, World Scientific, © 2012

## SUMMARY

The impact of AEC is increasing as modern technology introduces new realms of material sustainment. While the physics and underlying causes are complex, there is a lot of science that is well understood relating to degradation of systems due to atomic effects. Nonetheless, to date the main approaches to address AEC involve maintenance, redundancy, and replacement.

**Modern technology introduces new realms of material sustainment.**

While we do not purport to have solutions, we have identified several application areas, both existing and future, where these concerns could become paramount. We have focused on microelectronics because they are so pervasive in DoD systems, and in society in general. As microelectronics' sophistication increases, atomic effects are likely to increasingly cause errors and permanent degradation, and these problems are likely to become more severe earlier. We also have noted that the harsh environments for stored nuclear weapons, nuclear waste disposal, nuclear power plants, and outer space give rise to degradation processes that include atomic effects corrosion, and sometimes these AEC processes can become the underlying cause for classical corrosion. The next chapter proposes approaches to address AEC, with the ultimate goal of offering opportunities to improve material sustainment in the face of AEC and other corrosion mechanisms, rather than react to its effects after the fact.

# CHAPTER 3: RECOMMENDATIONS

We introduced this book with the argument that in order for DoD to improve material sustainment, a broader definition than the classical, chemical environment based definition of “corrosion” was required. We pointed out that there are mechanisms other than chemical corrosion that cause materials to degrade, and proposed a corrosion spectrum to categorize these mechanisms and their effects. The spectrum includes classical corrosion (molecular level), introduced a new term for macromolecular-level degradation that we called “biological effects corrosion,” and at the atomic level, explored the atomic effects corrosion (AEC) that is the focus of this book. In sum, chapter 1 introduced the topic and addressed the question, “Why should anything change?” in the concept of **prevent, detect, monitor, and manage** corrosion and degradation.

**“Why  
should  
anything  
change?”**

With chapter 1 as background, chapter 2 describes the mechanisms of corrosion and degradation, including a brief overview of classic corrosion and a more in-depth description of AEC mechanisms. In sum, addressing the question, “What are the mechanisms of materials degradation?” en route to recommending a broader approach to dealing with corrosion and degradation that we called material sustainment.

**“What are the  
mechanisms  
of materials  
degradation?”**

This chapter addresses the “So what do we need to do?” question. That is, it recommends what we believe the DoD, and more specifically the Corrosion Policy and Oversight Office (CPO), should do about corrosion, materials degradation and material sustainment throughout the corrosion spectrum, and why considering all mechanisms of corrosion should be included. In this vein, we make recommendations in the areas of strategy, policy and research. These areas are all related (see The Corrosion Spectrum graphic on the following page). In fact, **our recommendations for strategy are all associated with policy** – essentially, we are recommending a strategic plan for identifying, organizing/prioritizing and implementing policy across the full corrosion spectrum. Therefore, we discuss strategy and policy together, followed by the research recommendations that provide the scientific underpinning for both.

**“So what do  
we need  
to do?”**

## DOD INTERESTS AND CPO MISSION

Before getting into the specific recommendations, it is important to answer another question, which is “What is the basis for a DoD office delving into areas (such as nuclear power plants) that are controlled by other agencies (such as DoE)?” The short answer is because even though DoD does not “own” some of these areas, DoD does have interests in them. The Corrosion Spectrum graphic below provides an overview of how each of these topics is important to the CPO – the DoD agent for corrosion prevention and management, even if the systems in these areas are not all controlled by the DoD. At the top is the corrosion spectrum that affects all materials, with the three basic categories that detract from material sustainment. On the left and right sides are DoD Interests and Needlines, respectively, both of which CPO currently manages in the classical corrosion arena. In the area of classical corrosion, the CPO’s mission (which we argue should be across the spectrum) is to develop a comprehensive capability to prevent and mitigate corrosion and its effects on DoD systems and infrastructure.

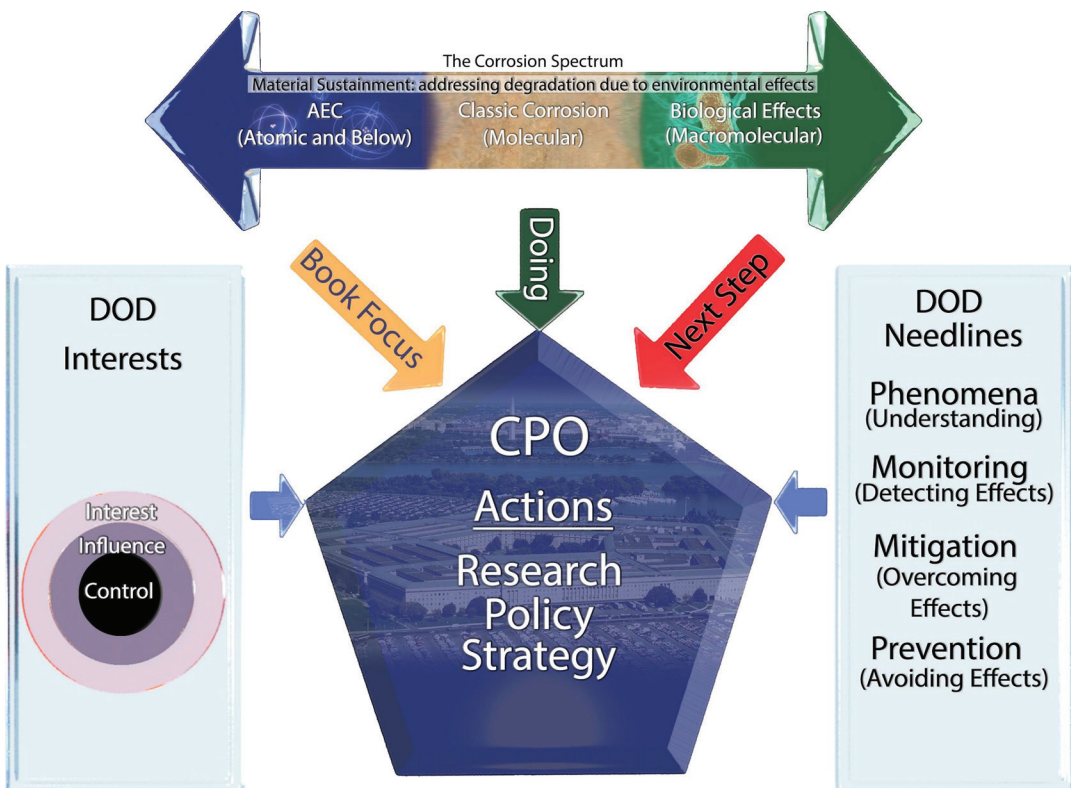

Corrosion Spectrum Diagram/Alex Taliesen



In order to carry out its mission, any DoD organization has three levels of involvement: control, influence and interest. For example, the DoD controls conventional military systems, which are directly acquired, operated and maintained by military Services. At the next level, DoD can influence areas it does not control; for example, Air Force aircraft transport and launch the airborne weapons that comprise the aerial dimension of our nuclear deterrence triad, and Navy ballistic missile submarines transport and launch undersea strategic nuclear weapons. In an area where two or more agencies control specific aspects associated with the application of national capabilities, each is said to have influence in that area. For example, the Air Force and Navy specify the unique conditions in which the nuclear weapons they transport/launch must operate effectively. In some areas, such as space satellites, DoD neither launches nor operates satellites, yet DoD has direct interests in the satellites' products, such as the imagery needed to produce critical intelligence for our operating forces. So even though DoE controls nuclear weapons and NASA manages space systems, the DoD has interests in the application of those weapons and space systems. The point is *not* that DoD should have more control over more areas, but that it needs to coordinate with other agencies to further our national interests. As we will point out in the recommendations throughout this chapter, in the area of corrosion/degradation and material sustainment, there are areas where this coordination needs to expand as technology continues to advance.

Furthermore, and as we'll illustrate with a specific example later (see Objective 2, Develop a Broader Coordinated Research Program), we assert that cross-boundary coordination between agencies can result in new and improved systems that are beneficial to both, regardless of their particular spans of control. This is a primary motivator for recommending a coordinated research program. Though listed as "DoD Needlines" on the right side of the graphic, in reality all agencies with material sustainment requirements have the same Needlines. All agencies need to understand the fundamental phenomena that affect their material systems, all need to monitor and mitigate the effects of corrosion/degradation, and, ultimately, all would like to be able to design systems that prevent corrosion or degradation in the first place. We'll discuss the strategy and policy implications first, and then specifically address the necessity for deeper scientific understanding in the research recommendations, but the bottom line is this: if we can understand materials and their behaviors *from the bottom up* (i.e., from AEC through biological effects corrosion), then rather than engineering new systems from empirical data alone we will have the opportunity to know how their fundamental properties translate into both micro- and macro-level performance. Coupling this basic understanding with improved predictive models can result in a national asset that can be applied to material sustainment across the board.

**The point is not that DoD should have more control over more areas, but that it needs to coordinate with other agencies to further our national interests.**

As a simple example of what we mean by “from the bottom up,” let’s return to our caveman, “Og,” of chapter 1. He learned that if he whacked something with a club, the effect was greater (and less painful) than whacking it with his own fist. That is empirical evidence: essentially the result of trial and error. Empirical results can be a powerful tool, as anybody without a club would have found out if he engaged in combat with Og. If, on the other hand, Og had possessed the capacity to do the research to develop the science to understand the fundamental properties of materials, then he would have the opportunity to design a club that wouldn’t eventually rot (that is, Og could have accomplished *bottom up corrosion prevention planning*).

To finish the discussion of the Corrosion Spectrum graphic, the “stoplight” colored arrows point out where CPO stands in our proposed three areas of the corrosion/degradation spectrum. The green arrow indicates that there is already a lot of strategy, policy and research in the area of classic corrosion that is being coordinated and managed by the CPO in accordance with the current Title 10 definition of corrosion. The yellow arrow is the subject of this book, in which we argue for broadening the definition beyond classical corrosion, and then address one of the broadened areas, AEC. The red arrow simply indicates that biological effects corrosion is currently lacking research and policy recommendations (the next book in this series will address this topic).

With the above as context, and the interrelationships between strategy, policy and research, we could start with recommendations in any of the three areas. We start with strategy and policy, then address research. The recommendations we address in the remainder of this chapter are summarized below.

AREA	RECOMMENDATIONS
Strategy/Policy Objectives	1 Develop a comprehensive strategy for the corrosion spectrum.
	2 Establish a broader coordinate research program that crosses boundaries in the corrosion spectrum.
	3 Identify and make specific policy changes based on research outcomes.
Research Directions	1 Build for Reliability
	2 Identify thresholds where AEC matters

## STRATEGY AND POLICY

Given an expanded definition of corrosion as described by the corrosion spectrum (though we prefer the term “degradation” spectrum to distinguish between the classical definition of corrosion as involving chemical reactions, we will stick with “corrosion” for the sake of consistency), it makes sense that to address the broadened spectrum effectively, the CPO needs a strategy and accompanying strategic plan to organize and prioritize the policy implications.

There are numerous methods for developing strategy and strategic plans. The military Services use the concept of ends, ways and means. Conceptually, strategy describes the relationship among ends, ways, and means.<sup>1</sup> *Ends* are the objectives and goals sought. *Means* are the resources available to pursue the objectives. And *Ways* are how (i.e., methods) one organizes and applies the resources. Each of the components addresses a related question: What do we want to accomplish (ends)? With what resources (means)? How do we apply resources to achieve ends (ways)?

The CPO is the OSD office charged with achieving the end of reducing materials degradation so that our military material systems sustain their functionality and effectiveness. CPO's goal is to reach this end via the ways of prevention, detection, prediction and management of materials degradation. The ultimate end for the CPO is to ensure that DoD assets and infrastructures are always in a state of readiness so that Service personnel can complete their mission without unexpected or unmitigated materials degradation reducing their effectiveness. In the current budget arena, with reduced resources, the Services are planning to keep equipment – particularly major systems – in operation for longer periods, simply because they cannot afford to replace it. The CPO mission becomes even more important in such circumstances.

**Ends are the objectives and goals sought. Means are the resources available to pursue the objectives. And ways are how (i.e., methods) one organizes and applies the resources.**

A key element of the CPO's strategy for ensuring that DoD assets and infrastructures achieve this End is to promote the philosophy of material sustainment, or ensuring materials are functional throughout their life cycle and degrade on timescales that are predictable. In order to properly do this, a deep understanding of degradation processes is needed. Limiting the development of this understanding to classical corrosion only limits the ways and reduces the ability to assemble the means to achieve this end. It should be clear that the CPO needs to address the full spectrum of corrosion in order to maximize our material sustainment capabilities.

For this reason, we recommend that the CPO needs a strategic plan that addresses the full spectrum of corrosion, and that identifies ways to keep equipment ready and operating for longer periods. It is not unusual for military systems to remain in operation beyond their design limits, and in the current budget environment, we expect that even more systems will have their service lives extended. Certainly, the recommended strategic plan will address classical corrosion along with the other elements of the spectrum, including AEC and biological effects. Just as certainly, even though the focus of corrosion policy and research has been on classical corrosion, by no means have all the problems in that arena been solved. In short, we are not recommending a change in focus, but an expansion to include the other components of the corrosion spectrum.

With an expanded corrosion spectrum, obviously the CPO will need to seek new ways and means for achieving the ends of material sustainment. Updated policies (ways) addressing the full spectrum of corrosion are needed, and the resources (means) that will

1. Robert H. Dorff, "A Primer in Strategy Development," in U.S. Army War College Guide To Strategy, eds. Joseph R. Cerami and James F. Holcomb, Jr., (Carlisle Barracks; Strategic Studies Institute, February 2001), 11.

be available to the CPO are limited. As a result, we suggest that a carefully constructed strategy that addresses issues of both policy and research within the available means (to include leveraging other means – see Objective 2, Develop a Broader Coordinated Research Program) is critical. The figure below depicts the complexity of strategy development, and thus emphasizes the importance of carefully constructing such a strategy.

Note that the military definition of End includes both goals and objectives. It is often useful to break down the overarching goal into more closely defined objectives that, together, improve the chances of reaching the desired end goal.

**We recommend three specific objectives for the CPO strategic plan to achieve material sustainment:**

- 1 Develop a comprehensive strategy for the corrosion spectrum.
- 2 Develop a broader coordinated research program that crosses the boundaries in the corrosion spectrum, especially in areas where corrosion mechanisms in different parts of the spectrum are coupled.
- 3 Identify and make specific policy changes within the comprehensive policy based on research outcomes.



Clearly, these objectives are all related. The comprehensive policy will identify areas where research is needed, including coordinated research. By the way, when we use the term “coordinated research” we mean research that crosses traditional boundaries between the sciences (e.g., chemistry and physics), or between specific research areas within those sciences (e.g., between the physics of statistical mechanics and organic chemistry). By extension, coordinated research also includes crossing traditional boundaries between government agencies such as DoD, DoE and NASA. Let’s describe each objective in turn.

### ***Objective 1: Develop Comprehensive, Full Spectrum Corrosion Strategy***

A key element of the CPO strategic plan is developing a comprehensive strategy that expands from classical corrosion by adding the other elements of the corrosion spectrum: atomic effects corrosion and biological effects corrosion (we remind the reader that this book only introduces the idea of biological corrosion, and the next book will address the associated mechanisms in detail). As far as the structure of the comprehensive policy, we believe a model for it already exists in the CPO’s existing policy. For example, DoD Instruction (DoDI) 5000.67, *Prevention and Mitigation of Corrosion on DoD Military Equipment and Infrastructure* addresses Title 10 authority and provides the associated definitions, policy and responsibilities.<sup>2</sup>

#### **This Instruction delineates five policy areas, summarized below:**

- Address corrosion prevention and mitigation in trade-off decisions involving cost, useful service life, and effectiveness.
- Implement corrosion prevention and control (CPC) programs and preservation techniques throughout the life cycle of all military equipment and infrastructure.
- Review and evaluate corrosion plans for acquisition category (ACAT) I<sup>3</sup> programs, and raise issues to the Defense Acquisition Board.
- Assess military equipment logistics and financial systems for corrosion-related information to address CPC and related logistics and readiness issues.
- Submit information (each of the Military Departments) on proposed corrosion programs and corrosion-related research, development, test, and evaluation (RDT&E) funding to CPO.

To assist in implementing policy, research and solutions in these areas, the CPO-sponsored [www.cordefense.org](http://www.cordefense.org) website provides easy access to a wide range of resources targeted to both corrosion professionals and others (such as DoD program managers) in

---

2. Office of the Undersecretary of Defense for Advanced Technology and Logistics, USD(AT&L), DoDI 5000.67, *Prevention and Mitigation of Corrosion on DoD Military Equipment and Infrastructure*, Feb 2010.

3. ACAT I, or Major Defense Acquisition Programs (MDAPs), are identified by their cost and milestone decision authority (MDA) levels. See, for example, <http://acqnotes.com/acqnote/acquisitions/acquisition-category>.

different disciplines who need corrosion related information. The website is constantly updated with new information and resources, and links to other corrosion-related websites.

Currently, CPO policy authority is limited to classical corrosion. Therefore, our first recommendation addresses expansion of this definition to include atomic and biological effects corrosion. The focus of discussion for this book is on AEC because the research and subsequent recommendations associated with biological effects is our next research task, and the subject of our next book. Regardless of the corrosion mechanism (classical, atomic or biological), these existing policy areas must apply in order to achieve the mission of fighting corrosion and improving material sustainment so that our Service personnel have ready, functional and effective equipment. So the question becomes, "What more should be done to improve material sustainment as corrosion policy expands across the spectrum?"

We recommend there are two additional areas that should be incorporated into the expanded policy: (1) increased coordination and cooperation with other Federal and state government agencies, and (2) a broader investigation and coordination of corrosion mechanisms in the areas of coupled and multi-mechanism corrosion. Let's describe what each of these areas entails.

The first area is increased coordination and cooperation with other Federal and state agencies. We have discussed the need for DoD to prevent, detect, monitor and manage corrosion and degradation in all systems associated with control, influence and interests. For example, DoD is interested in the sustainment of not only DoD, but also national, infrastructure. When the Services need to mobilize and deploy for military operations in our national interests, they need access to capable state and Federal infrastructure so that military forces can move from garrison locations to sea and air ports to deploy to the objective areas. In a large conflict, before deploying from garrison, the Services need to activate reserves and assemble them at military facilities, and those reserves need functional roads, bridges, railroads and airports to get to their assembly areas. Because many of the infrastructure corrosion mechanisms are indeed classical corrosion, CPO is already addressing the sustainment of national infrastructure, and has reached out to both Federal and state agencies in order to foster collaborative efforts to prevent corrosion and sustain our national infrastructure.

As AEC is further investigated, researched and identified, increased coordination and cooperation will be needed in the areas where AEC is likely to be most significant. These areas are primarily nuclear weapons, power and waste (DoE); space systems (NASA); and microelectronics (which have proliferated throughout the globe as well as our nation). We pointed out in chapter 2 that DoE has and continues to conduct research in a range of AEC mechanisms associated with nuclear systems. Furthermore, NASA has researched mechanisms of AEC in space systems. Both agencies' research tends to be focused on specific mechanisms and effects of interest specifically to them. We recommend that because DoD has interests in both these areas, it makes sense for CPO to coordinate more with both agencies to identify AEC mechanisms that have implications for multiple agencies, and also mechanisms that may become more important in broad

applications such as AEC in microelectronics. Where can DoE research into AEC associated with nuclear systems be applied to space systems, and vice versa? Which mechanisms DoE or NASA have researched may become important in non-nuclear, terrestrial microelectronics applications? We understand that there are highly classified specifics, particularly with nuclear weapons, but the underpinning basic science can be more broadly applicable. We recommend that CPO, with a broad focus on material sustainment in general, is ideally positioned to be the agent of increased coordination and cooperation with Federal agencies that specialize in a single area, such as DoE and NASA.

The need to improve coordination in AEC research is particularly acute as microelectronics incorporate reduced feature sizes and increased component densities. As increasingly sophisticated microchips are produced, we believe that AEC is going to become increasingly important. The commercial realm is driving the state-of-the-art in microelectronics, so in this area the task is more complex than direct interaction with other Federal agencies associated with nuclear and space systems. We believe that as microchip technologies improve, and AEC becomes more impactful, there will be more opportunities to address DoD interests in material sustainment of microelectronics. We recommend that CPO can lead this interaction, coordination and cooperation. In short, as CPO has improved classical corrosion mitigation, by applying the same general approach and developing specific AEC methodologies, CPO is ideally positioned to be the agent of increased coordination and cooperation with both the commercial microelectronics community and other DoD microelectronics-specific organizations such as the Defense Microelectronics Activity (DMEA).

To accomplish both these functions, CPO needs a comprehensive, full-spectrum corrosion policy along with a strategic plan for coordinating and cooperating with Federal, State and commercial activities. The CPO's history of coordination and cooperation in the classical corrosion arena provides a model that can be adapted to the broader roles associated with prevent, detect, monitor and manage corrosion in pursuit of material sustainment across the corrosion spectrum.

In association with a comprehensive policy and strategic plan for coordinating, it is reasonable to ask, "What needs to be coordinated?" in the corrosion spectrum. We believe there are two answers to that question. The first is to expand the types of cooperation among different agencies addressing the same kinds of problems, as CPO already does in the classical corrosion arena. So our recommendation here is to simply broaden the kinds of coordination initiatives CPO already promotes. The second is to promote and manage research into what we call coupled or multi-mechanism corrosion that crosses the boundaries of the spectrum. As illustrated in the cancer example in chapter 2, things that happen in one area of the spectrum can cause effects in another; for example, an AEC effect can be a cause of classical corrosion. Recall our observations on research: specifically, there is a lot of excellent

**The need to improve coordination in AEC research is particularly acute as microelectronics incorporate reduced feature sizes and increased component densities.**

research that has been completed and that is still underway, but this research tends to focus on a specific effect, and research projects tend to be of relatively short duration. Such research must continue, but we recommend that CPO's mission to understand all corrosion mechanisms should include the task of developing and implementing policy for a coordinated research program to address the broader issues of cross-boundary coupled, multi-mechanism corrosion. This research would build on existing and on-going research into specifics, explore how causes in one area of the spectrum may produce effects in another, take a longer-term view of reviewing specific research and identifying areas where one agency's results can apply to another agency's problems, and also foster cooperative, multi-disciplinary research to address "wicked hard" problems such as tin whiskers (which we'll discuss more in the research recommendations section).

In sum, the only issue with the current CPO policy is that it is currently limited (by Title 10) to classical corrosion. CPO needs the authority to expand beyond that limitation, into atomic and biological effects corrosion. Of course, that is easier said than done – and dependent on obtaining results in the other objective areas of coordinated research and specific policy updates. On the other hand, it is not necessary to start from scratch in this endeavor. As we described in chapter 2, there is *a lot of* science already completed on AEC, and we suspect we will find the same in biological effects corrosion when we research that area in detail. What is needed, and is the topic of the next strategic objective, is better coordination of research in specific areas, and in determining the coupled and related mechanisms associated with AEC and classical corrosion (and, by extension, biological effects corrosion). So let's move on to that topic.

### ***Objective 2: Develop a Broader Coordinated Research Program***

We have defined coordinated research as research that crosses traditional boundaries between the sciences, between specific research areas within those sciences and, by extension, coordination crossing traditional boundaries between government agencies. Perhaps a historical example will help explain what we mean before we describe this objective.

Before the first microchip was developed, it was well known that space is a high-radiation environment. When microchips were first introduced into space systems, radiation hardened or "rad hard" microchips were built in small foundries based on custom designs using exotic materials and components to harden the chips from the effects of radiation. In short, rad hard was achieved by custom designs, and rad hard chips were built in small quantities. Because these designs were so specific and so limited, the cost per chip was much higher than commercial microchips with broad applications that were manufactured in the millions. In the 2000s, scientists at the Defense Advanced Research Projects Agency (DARPA) with a commercial manufacturing background wondered if they could meet the need for radiation hardening by commercial microchip manufacturing along with specialized processing methods such as circuit mitigation and error checking techniques. They found that it was indeed possible, which allowed advanced commercial designs to provide the required radiation hardening without the need for specialized, custom, exotic materials fabrication targeted to single, spe-



cific uses. Though this development was not without controversy (particularly from the specialized foundries), the point is that by *crossing the boundary* between specialized microchip foundries and commercial designs hardened by processing, commercially-designed chips (the hardware) plus processing (the software and techniques such as circuit mitigation) could withstand the high radiation environment of space, and could do so more cost effectively.

The above is just one example, but a trend we have noticed in our research for this book – especially (and understandably) in the very sensitive and highly-classified areas associated with nuclear weapons – is that it is very easy for scientists to become pigeonholed into very specific areas, and the cross-fertilization between results in one area and their potential application in another is lacking. Why is this important? Let's return to our cancer example from chapter 2: diseases like cancer remind us that when things degrade on the smallest scale, the result can have a serious impact on our daily lives. A cancer that begins in an individual cell degrades the nucleus of that cell, which can spread to other cells, which collectively degrade the tissue or organ, which degrades the human being that is made up of cells, tissues and organs. Fundamentally, the same cascading effect can happen via AEC if, for example, a neutron collision degrades a material lattice, which degrades a transistor, which degrades the chip, which degrades the computer, which degrades the weapon system.

Somewhere between the neutron that degrades the material lattice and the degraded chip, we transition from AEC to classical corrosion. The point is that the excellent but very specialized science being developed for specific applications is not sufficient. Therefore, we need a *coordinated research program* that seeks potential cross-boundary implications and coordinates the scientific investigation to determine the causes and effects of observed degradation effects at all scales (atomic/sub-atomic, molecular, macromolecular). It is certainly understandable that scientists involved in specialized investigations are focused on the specialized problem they are trying to understand and resolve. As science has grown more sophisticated, it is natural for increased specialization to occur simply because a single mind cannot comprehend it all at the detailed level. However, it is not necessary to understand *all* the details to identify areas where results can cross boundaries.

For this reason, we recommend that CPO develop a coordinated research program not to investigate the science per se, but to identify problem areas where coordination of different scientific investigations is needed. That is, CPO's role is not to do the science, but to coordinate its investigation and "cross-pollination" between the very specialized fields, communities and organizations. In simple terms, what we are recommending is that CPO should, in concert with a broader definition that includes the corrosion spectrum, seek out areas where the materials degradation problems are or could be crossing boundaries. Obviously, cross-boundary problem identification includes coordination with other government agencies such as DoE and NASA. Equally obviously,

**The point is that the excellent but very specialized science being developed for specific applications is not sufficient.**

there will be some areas where the investigation and implications of research in specific areas such as nuclear weapons sustainment will be so sensitive that they are classified and compartmentalized. But we believe that at the basic science level, those will be relatively few, and the potential gains from coordinating research on common problems are tremendous. In sum, the recommended coordinated research program includes both identification of cross-boundary research and also cross-agency coordination.

One additional, much-simplified example (addressed in more detail in the research section) supporting coordinated research is the tin whiskers that occur when lead-free solder is used (by the way, "tin" is not the only metal that can result in "whiskers," just the most commonly observed; "metal X" whiskers are possible, and have been observed, in multiple lead-free solder applications). Tin whiskers, because they are metal, are electrically conductive structures that grow from surfaces where tin is used; they can occur in both terrestrial and space applications. If they grow in the wrong places, they can short out electronic circuits, and as the node sizes of microelectronics decrease, their effects are likely to become more pronounced. Tin whiskers were first observed in the vacuum tube era in the 1940s and 1950s.<sup>4</sup> Yet to date, there is no single accepted explanation of the mechanisms that cause tin whiskers. Generally, they are recognized as being initiated by atomic effects (they grow atom by atom), but they have effects (e.g., circuit shorting) commonly attributed to classical corrosion. With the multiple physical phenomena potentially underlying the cause of tin whiskers, it seems logical that coordinated research addressing the problem from multiple perspectives might have a better chance of succeeding where individual research efforts to date have not succeeded.

One final recommendation on a coordinated research program: a focus on longer-term problems and complex mechanisms that combine multiple individual causes and their effects is needed. As science has specialized, it is only natural that scientific investigations would specialize, too. The results of our investigation of degradation mechanisms have resulted in identification of a trend toward investigating specific, specialized cause

**...we need a component of the coordinated research program that also looks at broader, longer-term effects and the scientific investigations that need to be conducted to connect individual mechanisms.**

and effect mechanisms in short-term projects. Doing this science is without doubt a good thing and has advanced our scientific knowledge, but we need a component of the coordinated research program that also looks at broader, longer-term effects and the scientific investigations that need to be conducted to connect individual mechanisms. Again, our cancer analogy applies: we need to identify those areas in which one cause results in an effect, and that effect becomes the cause of another effect, and so on. As our scientists

rightly pursue the specifics, we need to identify the longer-term chains of mechanisms that start at AEC, move "up" to classical corrosion, and ultimately result in biological degradation effects.

4. NASA Basic Info/FAQ: <http://nepp.nasa.gov/Whisker/background/index.htm>.

### *Objective 3: Enact Specific Policy Changes Based on Research Results*

A comprehensive policy is a starting point that provides context to the investigation and resolution of problems within the corrosion spectrum, including both single mechanisms and the impact of cross-boundary mechanisms. Because we address research mechanisms in more detail in the following section on research – including both general research directions and specific examples, and because the impacts of specific research remain to be determined, we do not yet know what those specific policy changes will be. We do know, however, that specific changes will be needed as we uncover more degradation mechanisms and related connections. The figure below shows a researcher in a laboratory – as she achieves research results, the policy implications need to be examined, too.

Therefore, we recommend recognition that as science develops, its policy implications also develop. This is true in a broad range of arenas; for example, Einstein's research leading to the theory of relativity, and the subsequent development of atomic weapons and their use in World War II, certainly led to policy and strategy changes in both the military and political arenas. Though we expect few implications so impactful as Einstein's discovery, we also recognize that as science develops, so also must policy. And as policy develops, strategic plans need to adjust to policy changes.

Fineart1/www.shutterstock.com

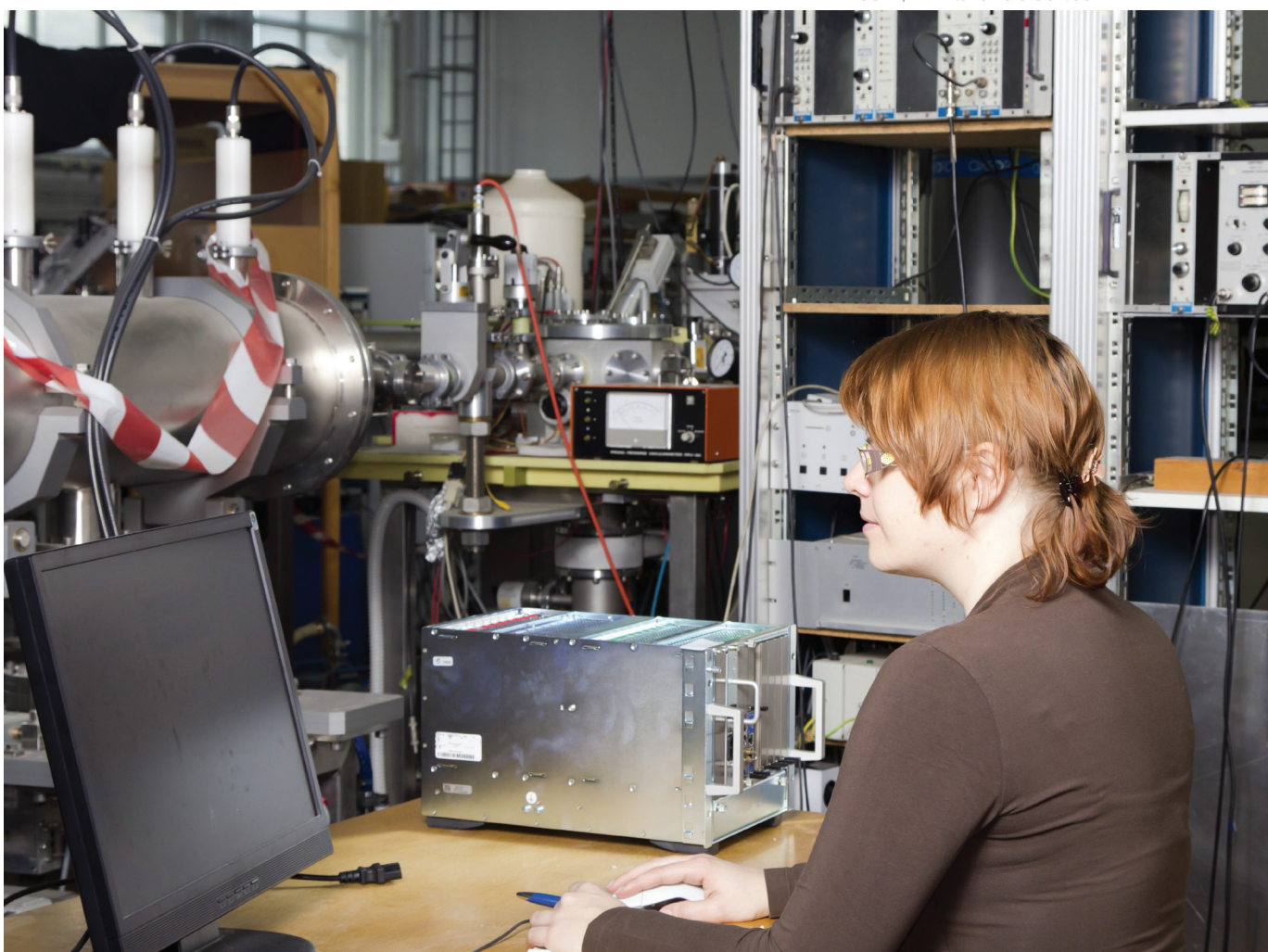

The point is that as research continues, including coordinated research, there will be specific policy implications, and therefore the need to develop (and thus change) policy, will undoubtedly occur. As a result, we recommend that as research results emerge, the CPO should be prepared to alter specific policies that implement the results of that research. CPO has certainly done so in the past in the area of classical corrosion, so to them this is not a new idea. We simply point out that scientific progress also results in policy changes. Therefore, corrosion (degradation) policy will evolve as the science to prevent, detect, predict and manage materials degradation evolves to improve material sustainment. Now let's move on to the area of research.

## RESEARCH

We have already touched on research in association with discussions of strategy and policy: the three areas are closely intertwined and it is impossible to discuss any one area effectively without reference to the others. Strategic plans propose policy changes that result in new research requirements. Policies direct research that results in changes to strategy. New research can lead to policy changes that update strategies. In this section, we recommend general research directions, and also provide some specific research examples, in order to illustrate the importance of research throughout the corrosion spectrum in providing the foundational science for good corrosion strategy and policy.

The goal of this section is to "prime the pump" for research in support of potential specific strategy and policy changes. The first topic is what we call "build for reliability." What we mean by this term is conducting research that enables understanding of physical phenomena and interaction mechanisms throughout the spectrum of corrosion. The intent of this research is to identify opportunities to change how we design systems from the "bottom up." That is, rather than engineering from empirical data, study material properties and interactions at the fundamental level, identify how those properties and mechanisms translate into both micro- and macro-level properties, and then design systems founded on the basic science of materials. For example, a *Materialstoday* paper on nuclear reactor materials argues:<sup>5</sup>

*"Minimizing the rates of materials degradation will be possible only if the mechanisms by which it occurs are understood. Atomic-scale experimental probing as well as modeling can provide some answers and predict in-service behavior."*

In this paper, the authors argue that the investigation of atomic-scale degradation – which we call AEC – can allow understanding of how atomic interactions affect the macro behaviors of materials used in nuclear reactors. What this means is that they recognize that AEC mechanisms, once understood, are critical to selecting materials for designing improved nuclear reactors. By extension, improved designs to prevent or mitigate degradation are possible if we can understand the underlying mechanisms that produce them. As we discussed earlier, Og the caveman selected a club based

---

5. Marquis, Emmanuelle A. et al. "Nuclear reactor materials at the atomic scale." *Materialstoday* 12, no. 11 (2009): 30-37. <http://www.sciencedirect.com/science/article/pii/S1369702109702962>.

on empirical evidence that he could whack things harder when he used that club. But Og had no scientific evidence of what causes the degradation mechanism (rot) that eventually resulted in that club becoming useless. Even with our advanced science, we still design systems today based on empirical results: we have observed over time that material A works better or lasts longer than material B, so we use material A to build our system. When the science of those materials and how they degrade is better understood, we have the opportunity to select or design better materials and apply them to improved designs a priori rather than after extensive experience – in short, this level of understanding allows us to pro-actively “get ahead of the game” rather than reacting based on experience.

The second topic is what we call “identify thresholds.” What we mean by this is determining when AEC *matters* in terms of both numbers of events and time. Chapter 2 has already pointed out multiple AEC mechanisms, and for some of them the numbers of events are sufficiently low that at least in current systems, they don’t have a noticeable impact during their design life cycles. We anticipate that as the nodes decrease in size and component densities increase, AEC in microelectronics will become more important, and we recommend research to identify the thresholds and service life expectancies for which AEC will matter in the future.

Let’s look now at each of these areas in turn, along with a few illustrative examples, in order to understand how research is fundamental to improving material sustainment. Inevitably, one can argue that an example included in Identify Thresholds can affect Build for Reliability, or conversely, and the argument is valid. So the organization of our examples is somewhat arbitrary. We include the examples where we do simply to indicate how specific research can contribute to general research directions.

### *Examples: Build for Reliability*

The basic tenet of build for reliability is contained in its name: the desire to build systems that are as reliable as possible throughout their life cycles. Supporting this desire is the need to understand the basic science associated with materials and material degradation so that *each and every* component of a system contributes maximally to the system’s reliability. As we explained in the introduction to this section, developing the science to understand the fundamental properties and degradation mechanisms of materials at all levels enables a “bottom up” design that is based on sound science, not the trial and error of empirically based engineering. The goal is to understand *why* materials behave as they do, not just recognize that material A works better than material B based on experience.

The first research example is *tin whiskers*. The figure on page 78 shows the growth of tin whiskers on a circuit board. This phenomenon, which is the growth of electrically conductive tin structures on surfaces, can cause havoc in electronic circuits by posing a significant reliability risk in electronic assemblies where tin solder is used. Considered by many the best alterna-

**The basic tenet of build for reliability is contained in its name: the desire to build systems that are as reliable as possible throughout their life cycles.**

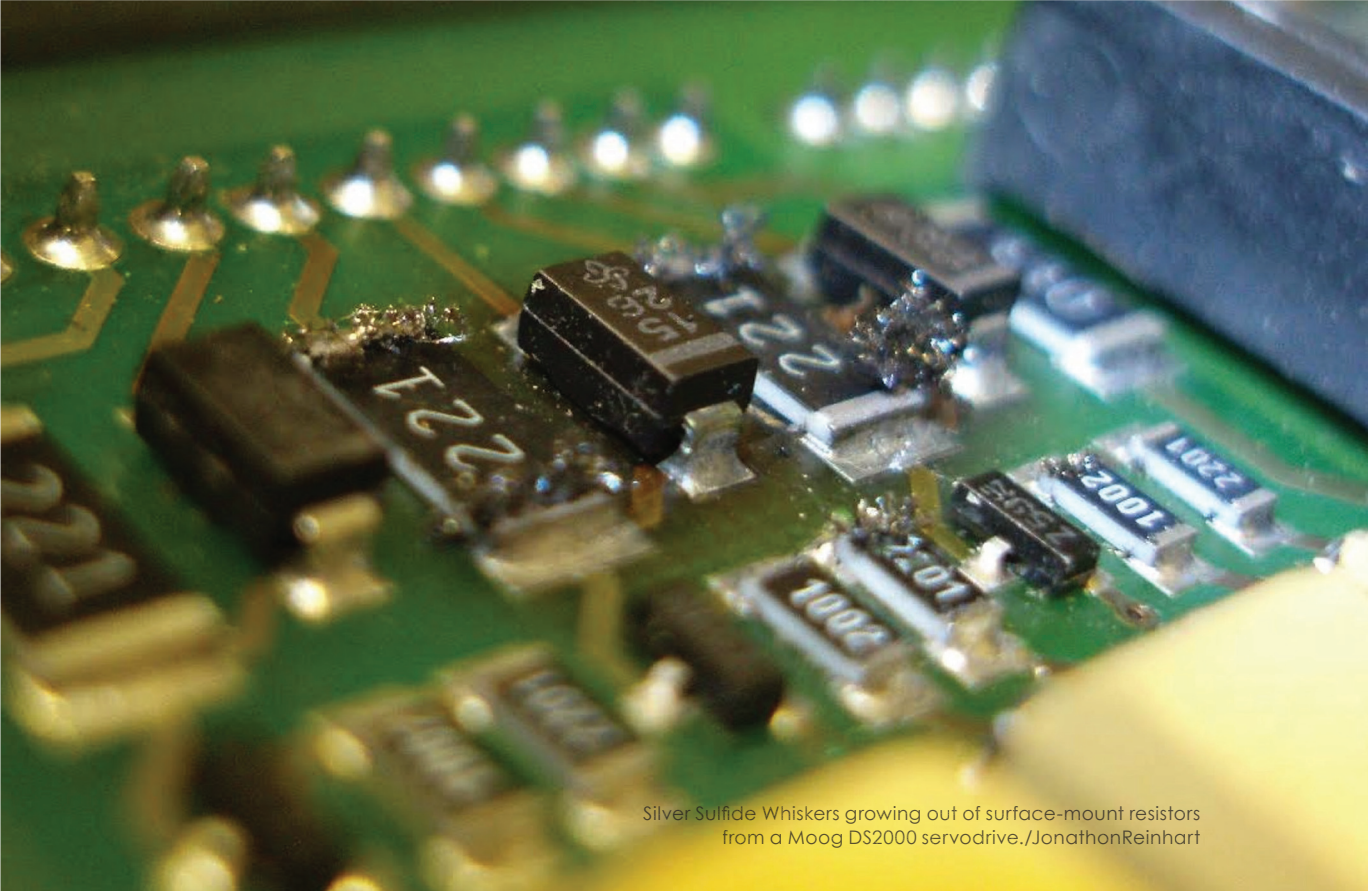

Silver Sulfide Whiskers growing out of surface-mount resistors from a Moog DS2000 servodrives. /JonathonReinhart

tive to environmentally caustic lead-based solder, tin solder is becoming more prevalent in electronics. NASA has a website<sup>6</sup> devoted to tin (and other types of metal) whiskers that notes that tin whiskers can cause both long-term and transient short circuits, metal vapor arcs, and contamination in electronic circuits. Tin whiskers are a significant problem in building reliable electronic assemblies, whether for use in the harsh environment of space or in terrestrial applications – tin whiskers have been observed in both.

Tin whiskers were first observed in the vacuum tube era of the 1940s and 1950s, yet to date NASA's website notes – in large red text for emphasis – that “A single accepted explanation of the mechanisms has NOT been established.”<sup>7</sup> The website points out that existing theories of tin whisker formation hypothesize that they occur by one of two mechanisms: (a) they grow in response to a mechanism of stress relief, or (b) they result from recrystallization and abnormal grain growth processes affecting the tin structures. In short, tin whiskers have been around for roughly seven decades, yet we still do not know what causes them.

We hypothesize that perhaps a build for reliability approach that investigates multiple mechanisms, or combinations of mechanisms, might produce more positive results in investigating the causes of tin whiskers. It could be that each of the two theories has merit, and maybe tin whiskers are the result of multiple AEC mechanisms (no one seems to seriously dispute that tin whiskers are initiated by atomic effects, even if they eventually cause other effects). Therefore, we recommend that a broad spectrum, cross-boundary,

6. “Tin Whisker (and Other Metal Whisker) Homepage,” *NASA.gov*, 8 May 2012, Accessed 25 Sept 2015, <http://nepp.nasa.gov/whisker/index.html>.

7. “Basic Information Regarding Tin Whiskers,” *NASA.gov*, 8 May 2012, Accessed 25 Sept 2015, <http://nepp.nasa.gov/Whisker/background/index.htm>.

multidisciplinary approach may yield better results than adherents of the two basic theories working separately. Could it be that stress relief mechanisms result in recrystallization and abnormal grain growth? We don't know, but we recommend that the topic of tin whiskers is important in research investigating AEC.

Tin whiskers cause problems in electronic circuits and microchips, but they are not the only AEC mechanism that needs further research. We have already pointed out, in the section describing the development of a broader coordinated research program, an example where cross-boundary investigation led to a more cost-effective approach to developing radiation tolerant, "rad hard" microchips. In this approach commercial foundry methods plus processing techniques resulted in rad hard chips without having to resort to small, boutique foundries using exotic materials to source these chips. The result was microchips with equivalent rad hard performance at lower cost. It was accomplished by a cross-boundary approach: commercial foundries employed manufacturing techniques developed for other types of chips plus processing techniques to a specialized, space application. The commercial methods crossed the boundary between high-volume consumer microchip development into what had previously been the highly specialized field of designing microchips specifically for operation in the harsh environment of space.

While the rad hard example demonstrates commercial techniques crossing the boundary into space techniques, we believe it could be useful to cross that boundary in the opposite direction. Commercial microchip manufacturers are concerned about reliability, even in the lower-radiation terrestrial environment. Developers of space systems require chips that must last for years in the higher-radiation environment of space, and in which you cannot simply replace a chip that goes bad to repair a system. Getting space system designers together to discuss lessons with the commercial reliability community is almost certain to result in identifying techniques from space systems that can be applied to terrestrial applications. CPO, with the mission of improving reliability for all DoD systems and infrastructure, could help coordinate these useful interactions. The image below and the diagram on page 80 depict areas where CPO can help coordinate interactions across boundaries.

Nuclear power plant/www.pixabay.com





geralt/www.pixabay.com

Similarly, scientists investigating failure mechanisms and reliability in the nuclear weapons, power and waste areas have a problem similar to one space system designers have: both communities' systems must work in a high-radiation environment for long periods of time. Many of the details of nuclear systems, particularly nuclear weapons, are highly classified. The basic science discoveries associated with investigating and overcoming failure mechanisms should for the most part not be classified. If they are, then government-to-government information exchanges can be conducted at the classified level. Scientists in the nuclear power arena are already working on better understanding of the fundamental mechanisms associated with designing nuclear reactors for reliability: their goal is to develop bottom-up designs based on rigorously-developed science rather than continuing to rely on empirical data derived from experience (which can be a harsh teacher: as the old aphorism says, "experience is what you get when you survive your mistakes" – source unknown).

Combining what we learn from continued research with better predictive modeling (another goal of the nuclear weapons community in an age where the U.S. no longer tests nuclear warheads) might result in cross-boundary applications developed from the exchange of information between the nuclear and space communities. Some results can probably also be applied to improving commercial microchip reliability, especially as the feature sizes in microchips decrease. Because the commercial foundries are driving



smaller feature sizes, all these communities could benefit from appropriate exchanges of information about basic science and predictive modeling.

We have already said that as science continues to develop, the scientists at the leading edge are growing more specialized. The body of knowledge has grown large enough that specialization is necessary – no one scientist can possibly “know it all.” The CPO can monitor developments and broker interchanges in the AEC arena that promote build for reliability in the same way that the CPO already does this in the arena of classical corrosion. All that would be needed is for CPO to expand an already-working approach for classical corrosion into AEC.

### *Examples: Identify Thresholds*

The other general research direction we have recommended is “Identify Thresholds.” As designs become increasingly sophisticated, AEC mechanisms that are not causing problems today may well do so in the future. At the macro level, we do not worry much about the effects of cosmic radiation on construction equipment, for example. The total doses are so low that other corrosion and wearout mechanisms result in the failure of these machines long before ionizing radiation results in any observable problems. The same is true of older-model microchips with relatively large feature sizes. AEC was certainly observed in these chips, but they were designed such that the radiation effects would be unlikely to cause a problem during the design life of the chip.

As feature sizes decrease and component densities increase in modern microchips, that may no longer be the case. The intent of Identify Thresholds is to promote research to determine when AEC is likely to become a problem, and develop methods to overcome it. Current design techniques, such as redundancy, are used to ensure that if AEC damages one critical part of the circuit, there are (usually multiple) backups for that function. Of course, having to include multiple backups for critical components obviates some of the advantages of increased component densities. If research could identify other techniques to overcome AEC in microchips, it would be possible to regain the advantages of advanced designs. To date, however, there are no known mechanisms by which high-energy radiation can be completely shielded, and for this reason we recommend coordinated research into Identify Thresholds, both in terms of understanding how AEC is caused and to develop ways to detect, predict, and manage it. In short, we need to know when AEC mechanisms are going to cause significant damage as microchips with smaller feature sizes are developed.

High-level descriptions of AEC mechanisms affecting microchips are described in chapter 2, and more scientific detail is available in appendix one. Examples of microchip AEC mechanisms include single event upsets, single event latchups, single event burnouts, hot-carrier injection, total ionizing dose, lattice displacement damage, electro-migration and dielectric breakdown. The effects of these mechanisms can be transient, such as changing the value of stored data, or can cause permanent damage. Currently, most of these effects are mitigated by empirically derived design features: redundancies, moving critical nodes further apart, and error correction processing techniques such

as parity checks. All of these introduce a penalty in microchip designs. As feature sizes become smaller and component densities increase, many of these effects may cause significant degradation to the microchips' function, requiring more redundancies or other features, and thus incurring an additional penalty that reduces the advantage of increased component density. As more modern microchips are developed, research is needed to identify thresholds at which AEC becomes significant.

The macro effect of corrosion from any mechanism on microchips is seen in microchip reliability and wearout. The graphic below illustrates experience in microchip life cycles. Early in a "new" microchip design, the primary concern is early life failures (ELF). Microchip foundries devote a lot of resources to mitigating ELF because they do not want to deliver defective microchips to their customers. Once the initial ELF issues are resolved, a given microchip design moves into the bottom of the "bathtub" depicted in the chart below. Once the initial "bugs" are resolved during ELF testing, a microchip becomes relatively stable and that style of chip is put into production. At that stage, a manufacturer is sufficiently confident in offering that particular model microchip for sale. Failures certainly occur, but they do so at much lower levels.

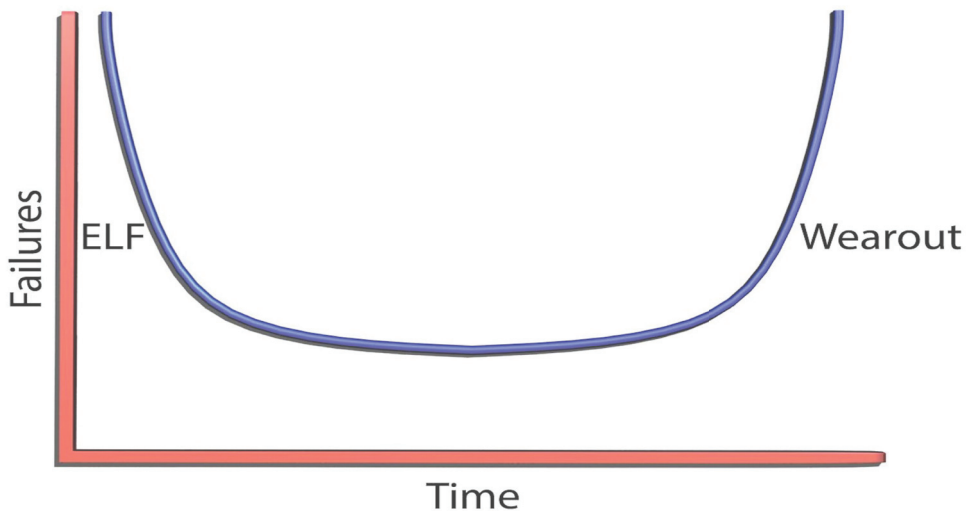

Experience in microchip life cycles/  
Alex Taliesen

Later in their design lifetimes, wearout mechanisms increase the failure rates in microchips, if for no other reason than entropy (the label scientists have assigned to the natural tendency toward more disorder). Nothing lasts forever, and all systems, including microchips, eventually wear out. Recognition of this fact is a major contributor to establishing the expected design life for any system. If, however, AEC is having significant effects,

microchips may experience premature wearout due to corrosion. Research is needed to identify the points, the causes and the timeframes at which AEC becomes significant in modern microchip designs to ensure that chips are not failing early due to corrosion instead of normal wearout mechanisms.

Microchips are not the only designs where AEC may occur. As Micro-electro-mechanical systems (MEMS) continue to develop, these orders-of-magnitude smaller machines may be damaged significantly by AEC. Nanotechnologies ("nanotech") manipulate matter at atomic and molecular levels in order to fabricate macro-scale products. Nanotechnologies are designed at the scale where quantum mechanical effects are important. Unlike a macro machine that will fail from classical corrosion or component wear long before radiation damage becomes significant, MEMS and nanotech may be damaged by much smaller doses of radiation. Research is needed to identify thresholds applicable to areas in which the radiation environment causes significant AEC in all areas where MEMS or nanotech are applied: space, nuclear and terrestrial applications may all be affected by AEC.

The CPO manages DoD's interests in all these arenas, and therefore can become the coordinating agent for research into the effects of AEC as microchips, MEMS and nanotech continue to develop. One purpose of coordinating research is so that as significant AEC thresholds are identified, the results can be shared with other communities. It may be that significant effects in one area are not so significant in another, but CPO can coordinate the research and make scientists and engineers in all arenas aware of significant results – as CPO does for classical corrosion today.

**Nanotechnologies  
are designed  
at the scale  
where quantum  
mechanical effects  
are important.**

### **SUMMARY: CORROSION AT THE ATOMIC SCALE REPRESENTS ONE AREA ON A SPECTRUM OF CORROSION EFFECTS THAT SPANS FROM THE NANOSCALE TO MACROSCALE**

The goal of the Office of Corrosion Policy and Oversight (CPO) is to help ensure that DoD assets and infrastructures remain in a state of readiness so that Service personnel employing them can successfully complete their missions. To do so, DoD assets and materials need to be reliable, technologically superior, and affordable. Part of the CPO's strategy for ensuring that DoD assets and infrastructures are secure is to promote the philosophy of material sustainment, which is intended to ensure materials are functional throughout their life cycles and degrade on timescales that are predictable. In order to properly do this, DoD needs scientific understanding of degradation processes. Traditionally, this understanding of degradation has focused on "classical corrosion," referring to specific material structures degrading due to bulk chemical effects caused by environmental forces that evidence themselves in macro structures such as bridges, aircraft and military vehicles. Corrosion in the classical sense deals with degradation events that

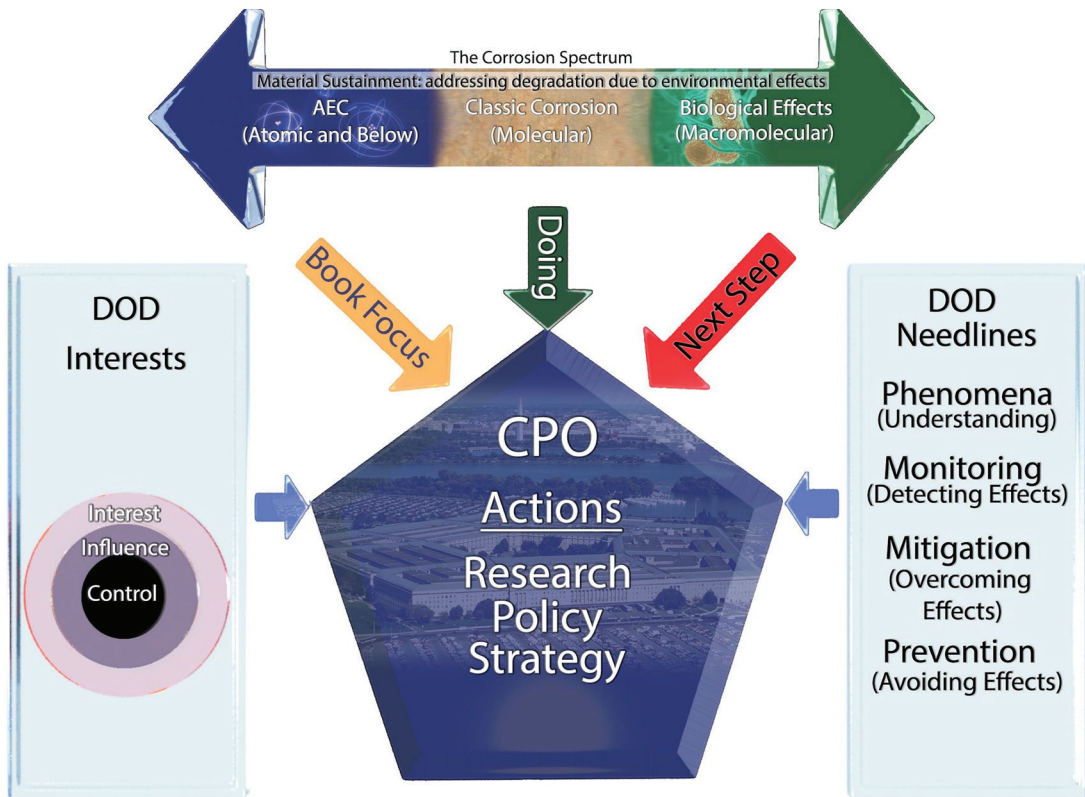

Corrosion Spectrum Diagram/lex Taliesen

are directly observable, such as metals rusting. There was no other broadly applied consideration of the way that materials could degrade. The results of this study shown in The Corrosion Spectrum graphic above indicate that this is an incomplete vision of the corrosion problem.

We have recommended that the corrosion spectrum, including AEC, classical corrosion and biological effects corrosion, requires studying degradation mechanisms and effects at all relevant scales. Matter has different properties at different scales, and the events that cause matter to degrade occur through different mechanisms and phenomena at different scales. For example, an aircraft is made up of many different parts, the parts include many different types of materials, materials incorporate different components that perform various functions, and "size matters" for many of those components to continue to function throughout their design life cycles. This is particularly true for DoD systems that are often retained in service beyond their original design life cycles. The metal that makes up the aircraft wing needs to have a certain type of composition, be a certain

thickness, and exhibit specific properties in order for the wing to perform as needed in the conditions in which the aircraft will be flown. The materials that make up a transistor that is part of a microchip that runs the internal computer system also need to be of a certain composition, be a certain thickness, and exhibit specific properties in order to perform as needed in the conditions in which the aircraft will be flown. The important distinction here is that the degradation mechanism that leads to the failure of the wing is different than the degradation that leads to failure of a transistor. The environment that the wing needs to be designed to endure is different than the environment that the transistor is designed to endure. This is because the wing and the transistor have different purposes and different designs, and are constructed at different scales, all contributing to the continued function of the aircraft.

Thus, considering a material sustainment strategy for an aircraft requires identifying the role that each component part plays in ensuring the overall function of the airplane. This means identifying the operating environment to which each part will be exposed, and identifying the different types of phenomena in each environment that can lead to the degradation. Because the parts of an airplane range in scale from nanometers to meters, the sources and mechanisms of degradation will be different for the different parts. Just as humans cannot “step on” bacteria to kill them, the mechanisms that degrade some materials may not affect others because they act at different scales.

This atomic effects corrosion (AEC) study revealed that a spectrum of corrosion effects exists. Attempting to categorize degradation events in the nucleus of an atom in chemical terms only, such as the energy required to disrupt a molecular bond, is incorrect. Therefore, limiting corrosion to the classical effects that occur at the scale of chemical interactions between molecules is insufficient. Recognizing this fact is not a new idea, but characterizing corrosion as the degradation effects at multiple scales throughout the corrosion spectrum offers increased opportunities to prevent, detect, predict and manage corrosion. It is important to note that the corrosion spectrum concept needs to be studied further and better defined. Our description here provides a starting point for AEC, and in the next phase of our study we will address biological effects corrosion.

What matters most in material sustainment is being able to understand the ways that materials can degrade. We contend that as materials become more complex, there are going to be more ways in which materials can degrade. The goal of material sustainment is to identify as many of the degradation pathways as possible for all materials, then develop strategies for detecting and preventing degradation, and finally to develop solutions for material degradation. Researching how degradation pathways work together to create failures in materials through processes that are not yet thoroughly understood offers opportunities to develop new solutions. Materials degrade through combinations of spontaneous degradation, high-energy, low-energy, and field effects. Focusing on single mechanisms of effects is important, and we applaud the body of re-

search that has been amassed to date, but we assert that understanding how combinations of effects cause degradation is also important. Studying the full spectrum of degradation pathways and developing solutions to them such as “bottom up design” can increase the confidence our Service personnel have that the systems and infrastructure they depend on are reliable and functional.

The point of this book has been to make the case to decision-makers and stakeholders in the design, acquisition and sustainment of material systems that materials degradation should be considered as a spectrum of degradation pathways dependent on several factors:

- The nature of materials
- The types and sources of degradation events
- The thresholds of degradation events that compromise a material's function or reliability.

The classical definition of corrosion worked well in the industrial age, but is insufficient in the modern age. For this reason, we proposed the corrosion spectrum that includes atomic level (AEC), molecular level (classical corrosion), and macromolecular level (biological) effects. To ensure that DoD systems and infrastructure are ready when our Service personnel need them, corrosion mechanisms and effects across this spectrum need to be determined so the CPO can *prevent, detect, predict and manage* corrosion in all forms, and thereby promote material sustainment.

**What matters most in material sustainment is being able to understand the ways that materials can degrade.**

Investigating the corrosion spectrum requires new research to identify new mechanisms and combinations of mechanisms resulting in materials degradation, thereby enabling science-based policy changes, managed with a strategic plan for developing and coordinating solutions that increase system and infrastructure reliability, and reduce sustainment costs.

# APPENDIX 1

## SCIENCE OF MATERIALS

This appendix discusses the science of materials. We also discuss the importance of understanding how a material's composition and structure are interconnected, and how these interconnections lead to the properties that give materials their capabilities. To demonstrate this point, we collect and overview science related to atomic effects corrosion (AEC). This appendix is not intended as a "textbook" – there are many textbooks and other resources available that delve deeply into various topics synopsized here, and several of these resources are referenced. Rather, its purpose is to provide the scientific rationale for thinking about materials at all scales, considering all structures, and relating this information to their properties. Thus, this appendix briefly describes the foundational scientific concepts required to understand AEC mechanisms. This discussion is intended to demonstrate that AEC is a largely ignored area of degradation in corrosion prevention and control (CPC) strategies, and to illustrate how understanding AEC mechanisms can enable a more thorough investigation of materials degradation in order to prevent, detect, predict and manage corrosion across the spectrum.

## THE SCIENTIFIC PRINCIPLES OF AEC

A material is defined as "the elements, constituents, or substances of which something is composed or can be made."<sup>1</sup> The field of materials science and engineering attempts to understand the intricate details of the forms of matter (materials) we use to build technologies and structures.<sup>2</sup> Until the invention of instruments like the scanning probe microscope (such as the example in the figure on page 88), a "top-down" science approach has been used to study the properties of materials.<sup>3</sup> Materials have mostly been studied with little information available about the precise arrangement of atoms. This new ability to study the underpinning science, and apply it to engineer materials at the nanoscale is revolutionizing our understanding of materials and their capabilities.<sup>4</sup> In the very near future we will see materials with new properties that outperform older materials. In addition, these materials will provide economic and environmental efficiencies as processes such as additive manufacturing mature.<sup>5</sup> These new materials offer the potential for new capabilities that can be applied to improve society and better protect the United States of America.

- 
1. "Material," *Meriam-Webster*, Accessed 09 Sept 2015, <http://www.merriam-webster.com/dictionary/material>.
  2. "Materials Science," *Wikipedia*, Modified 20 Sept 2015, [https://en.wikipedia.org/wiki/Materials\\_science](https://en.wikipedia.org/wiki/Materials_science).
  3. "Scanning probe lithography," *Wikipedia*, Modified 13 July 2015, Accessed 25 Sept 2015, [https://en.wikipedia.org/wiki/Scanning\\_probe\\_lithography](https://en.wikipedia.org/wiki/Scanning_probe_lithography).
  4. Marquis, Emmanuelle A. et al. "Nuclear reactor materials at the atomic scale." *Materialstoday* 12, no. 11 (2009): 30-37.
  5. "Company to Explore Nanocarbon as Working Material," *Nanowerk News*, 07 Oct 2013, Accessed 25 Sept 2015, <http://www.nanowerk.com/news2/newsid=32643.php>.

## Scanning Probe Microscopy (SPM)

Scanning Tunneling  
Microscopy (STM)

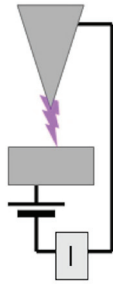

Atomic Force  
Microscopy (AFM)

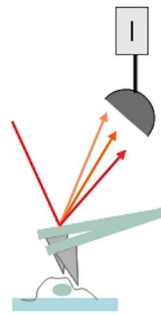

Scanning Near-field  
Optical Microscopy  
(SNOM)

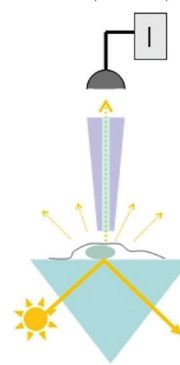

Overview of the main types of Scanning Probe Microscope types/Kristian Molhave/  
*Opensource Handbook of Nanoscience and Nanotechnology*

The emergence of new technologies requires an increased understanding of their scientific foundation so as to identify and mitigate mechanisms of degradation. Planning for a material's life cycle requires approaching material structures from the "bottom up." A bottom-up approach means understanding how the atomic structures of materials at the nanometer scale lead to the properties we observe at the microscopic and macroscopic scales. If we do not understand how a material is put together, how can we plan to mitigate the ways it may fall apart? For certain materials, the uses do not require a precise understanding of a materials underlying atomic structure because the engineered macrostructures serve their purpose without this knowledge. For example, steel beams have been around for decades, and we can confidently say it is not necessary for every atom to be placed perfectly because we have experience in the application of steel beams. But as nanoscale devices such as microelectronics and micro-electromechanical systems (MEMS) continue to advance, to maintain technological superiority, the DoD will need to consider new materials with optimized atomic structures to create macroscopic properties that support the development of new technology-enabled capabilities.

The periodic table categorizes the known elements, which are generally segmented into metals and non-metals. Materials are typically classified into four categories known as metals, ceramics, polymers, and composites.<sup>6</sup> Metals include all the metallic elements, such as iron (Fe), aluminum (Al), copper (Cu), and titanium (Ti), and these are always found in orderly atomic arrangements. Ceramics are typically ionic (sometimes covalent) compounds composed of non-metals and metals. These include metal oxides,

6. "General Material Classifications," *NDT Resource Center*, Accessed 08 Sept 2015, <https://www.nde-ed.org/EducationResources/CommunityCollege/Materials/Introduction/classifications.htm>.



nitrides, and carbides.<sup>7</sup> Silica is an example of a ceramic that is composed of a molecule containing a metal silicon (Si) atom bound with two non-metal oxygen (O) atoms. Polymers are typically associated with organic molecules (i.e., containing carbon (C), hydrogen (H), oxygen (O) and other non-metals). Plastic and rubber materials are polymers. Polymers are distinct from metals and ceramics in that they have large molecular structures that contain a backbone of covalently bounded C atoms.<sup>8</sup> Composites are hybrid materials that contain elements of metals, non-metals, and polymers. Table 1 summarizes the characteristics of metals, ceramics, polymers and composites.

Table 1: Comparison of material classifications.

MATERIAL	ATOMS INVOLVED	BONDING TYPE	PROPERTIES
Metals	Metals	Metallic and Covalent (occasionally)	Strong, High electrical and thermal conductivity, malleable, ductile, sensitive to corrosion.
Ceramics	Non-metals & Metals	Ionic & Covalent	Brittle, insulating, resistant to heat and corrosion,
Polymers	Non-metals	Covalent	Properties range widely from hard to soft, brittle to elastic, usually insulating, and resistant to corrosion
Composites	Longevity of Non-metals & Metalsharsh Environments	Metallic, Ionic, & Covalent	Combinations of the previous three material types. Properties range widely based on materials combined.

Each of these material types is classified according to certain chemical and physical properties. Those properties are dependent on their atomic and molecular structures. The relationships between the atomic structures of materials and the properties they exhibit are what materials scientists and engineers study. To develop new technologies or systems, material scientists and engineers need to understand the intended capabilities, and the associated underpinning chemistry and physics that provide the desired properties to achieve those capabilities. This requires understanding the fundamentals of the elements and the forces that control their behaviors and structures. Just as a painter's ability to create beautiful works of art depends on his/her knowledge of paints, a material scientist or engineer is limited to the kinds of materials he/she can create by the knowledge of atoms and molecules; in essence, a material scientist's or engineer's paints are the elements on the periodic table.

7. "Ceramic," *Wikipedia*, Modified 13 Aug 2015, Accessed 23 Sept 2015, <https://en.wikipedia.org/wiki/Ceramic>.

8. "Polymer," *Wikipedia*, Modified 24 Sept 2015, <https://en.wikipedia.org/wiki/Polymer>.

With the complete understanding of the chemistry and structures that give materials their capabilities, the properties of materials can be fine-tuned to meet specific requirements. The field of materials science and engineering breaks down material properties into six categories: **mechanical, electrical, thermal, magnetic, optical, and deteriorative**.<sup>9</sup> A material's capabilities depend on the types of elements that make it up and the ordered arrangement (i.e., structure) of these elements (as atoms, ions, or molecules). From a material sustainment standpoint, it is important to understand exactly how the fundamental properties of materials come into existence and why. The answer to "why" allows the material scientist or engineer to design a material for a specific function and understand how that same arrangement could degrade. It is important to recognize all the possible characteristics of a material rather than those required for a particular capability: this knowledge makes it possible to predict and understand how a material might degrade in different environments or when used in manners different than originally designed.

## THERMODYNAMICS OF MATERIALS

Thermodynamics is the study of energy flow between a system and its corresponding surroundings. The mathematics that explain thermodynamics are available in numerous textbooks; here, we provide a generalized description of the principles that matter follow.<sup>10</sup> In order to understand the basic driving forces that explain why materials conform to certain configurations and take on specific properties, it is important to understand the forces that affect the behavior of those materials.

There are four laws of thermodynamics, as depicted in the figures on page 91, that describe the behaviors of matter and energy.<sup>11</sup> They also define the fundamental physical quantities known as temperature, energy, and entropy that characterize all thermodynamic systems. The "zeroth" law of thermodynamics states that any two systems that are in thermal equilibrium with a third system are also in thermal equilibrium. This law is critical to a proper understanding and derivation of the concept of temperature. The first law states when energy passes into or out of a system, either as work, heat or matter, the internal energy of the system must change in accordance with the law of conservation of energy. This means it is impossible to invent a machine that runs without added fuel (energy): perpetual motion machines of the first kind are not possible. The second law of thermodynamics states that it is impossible for a system to undergo a cyclical process where its sole effect is the flow of energy into the system from a heat reservoir and the performance of an equivalent amount of work by the system on the surroundings.<sup>12</sup> Another way to say this is that any exchange of energy between a system and its surroundings must result in an increase in disorder of the universe. This concept is known as entropy, which is one of the fundamental laws that applies to the science of degradation. Materials represent ordered arrangements of matter, and the second law

---

9. D. William Callister, G. David Rethwisch, *Fundamentals of Materials Science and Engineering: An Integrated Approach* (John Wiley & Sons, Inc, 2012).

10. For a more detailed description see: Thomas Engel and Philip Ried, *Physical Chemistry* (Pearson Education, Inc: 2006).

11. *Ibid.*

12. Thomas Engel and Philip Ried, *Physical Chemistry* (Pearson Education, Inc: 2006).

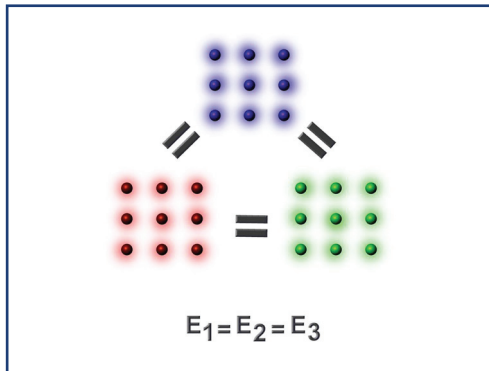

0. Three atomic systems in thermal equilibrium with each other demonstrating the zeroth law.

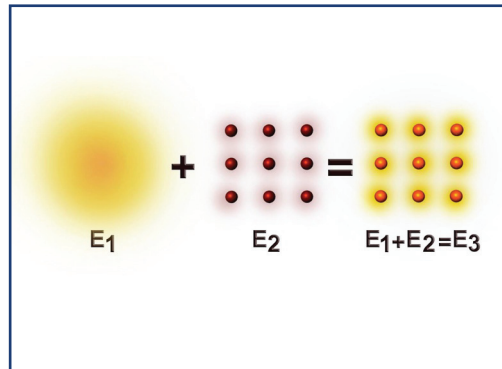

1. Energy ( $E_1$ ) is added to a system with an internal energy ( $E_2$ ) to give a new system with an energy that is the sum of  $E_1$  and  $E_2$  demonstrating the 1st law of thermodynamics.

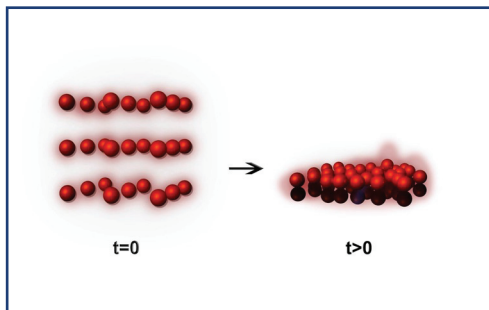

2. A system defined by an ordered lattice structure becoming more disordered as time increases demonstrating the second law of thermodynamics.

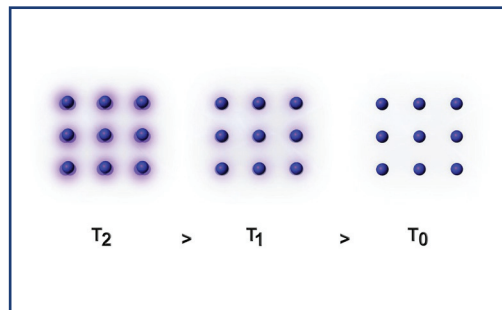

3. An atomic system that demonstrates the 3rd law of thermodynamics by showing that as the temperature approaches 0K the atoms in the system stop vibrating.

#### Four Laws of Thermodynamics./Alex Taliesen

of thermodynamics essentially says that even the most stable arrangements of matter are temporary in the grand scheme of things; all things degrade and return to a more disordered state. The third law of thermodynamics states that the entropy (i.e., level of disorder) of a system is well defined when it holds the minimum amount of energy it can. This minimum energy state is then defined as an absolute zero temperature; a system does not “move” at absolute zero. The third law is not directly relevant to the discussion of materials degradation, beyond establishing a temperature scale and giving that scale a floor.

In order for any system to change spontaneously, the system must enter a more stable state.<sup>13</sup> What this means is that the potential of a system to change is a reflection of the stability of the energy distribution of a system.<sup>14</sup> If there is a more stable way to distribute

13. *Ibid.*

14. Note: here energy of a system encompasses the energy of heat, work, and matter.

the energy in the system, then the system will do so until it reaches a state known as equilibrium.<sup>15</sup> At equilibrium, the net exchange of energy between the system and its surroundings is zero. The spontaneous transition of a system from one state to another results in the release of energy from the system to the surroundings. This phenomenon is mathematically expressed in thermodynamics as Gibbs free energy, shown in its simplest form below:

$$\Delta G = \Delta H - T\Delta S$$

For any potential process involving matter and energy change/flow, the change in Gibbs free energy ( $\Delta G$ ) can be approximated using this equation (or more complex variations of it<sup>16</sup>) with various known constants and measurements. The change in Gibbs free energy is the difference between the change in a term known as enthalpy ( $\Delta H$ ), which describes the change in internal energy of a system, and a term that describes the change in the entropy ( $\Delta S$ ) of the system at a particular temperature ( $T$ ). In order for a system to change spontaneously this difference has to result in a negative Gibbs free energy. If a system does not change, then it does not contain enough energy to overcome either an enthalpic and/or entropic energy barrier. If a system does change it is because a more stable future state became possible, or because energy has been added to the system (e.g., by heating) such that the system can overcome imposing energetic barriers. The degradation of a material at any scale can therefore be viewed as the result of a thermodynamic process, and the laws of thermodynamics state at least two things: materials will degrade naturally over time due to the driving force of entropy, and materials can degrade when phenomena cause energetic changes to that system (or the surroundings act on the system).



15. Thomas Engel and Philip Ried, *Physical Chemistry* (Pearson Education, Inc: 2006).

16. *Ibid.*

All atoms can spontaneously degrade over time, though for many it is highly unlikely. For those that do (e.g.,  $^{234}\text{U}$  or  $^{214}\text{Pb}$ ),<sup>17</sup> this phenomenon can create a problem when the decaying atoms are a part of or near certain types of materials. The decay of an atom results in the spontaneous release of energy, which can cause changes to the atomic properties of neighboring atoms. Such changes could, for example, help facilitate the diffusion of atoms within crystal lattice structures of a material. A change in the lattice structure could be all that is needed to ensure a loss of desirable capabilities of that material. Just as a tower of blocks can fail if one block is removed, materials can fail because a single atom moves. Atomic effects corrosion (AEC) happens when material failure begins at the atom. Understanding the phenomena that cause degradation to the atomic and molecular structures of materials is at the core of what is important when it comes to AEC.<sup>18</sup>

## PROPERTIES OF MATERIALS

We introduced the six commonly referred to materials properties in the field of materials science: mechanical, electrical, thermal, magnetic, optical, and deteriorative. In this section, we discuss each property as it relates to atomics effect corrosion. Deteriorative properties are referred to throughout this discussion.

### *Mechanical Properties*

Mechanical properties refer to a material's ability to remain in a particular atomic, micro, and/or macro configuration when a particular load or force is applied to that material for a specified amount of time, in a particular environment, and in a particular way. For mechanical properties, there are standardized measures used to communicate relative magnitudes of effects when discussing them. The American Society for Testing and Materials (ASTM) is one of the more active organizations in cataloguing the results of many standardized tests made to materials to determine their mechanical properties.<sup>19</sup>

There are many mechanical properties that are considered in selecting materials for an intended design, and we do not propose to explore each in depth here. Briefly, the most important mechanical properties refer to a materials strength, stiffness, hardness, ductility, plasticity, and toughness.<sup>20</sup> These are measured in several standard ways, including fracture toughness, tensile strength and Poisson's ratio. The fracture toughness measures how much energy a material can absorb

**The most commonly used material properties are mechanical, electrical, thermal, magnetic, optical and deteriorative.**

17. "Radioactive Decay," *Wikipedia*, Modified 24 Sept 2015, Accessed 09 Sept 2015, [https://en.wikipedia.org/wiki/Radioactive\\_decay](https://en.wikipedia.org/wiki/Radioactive_decay).

18. Emmanuelle A. Marquis, "Nuclear reactor materials at the atomic scale," *Materialstoday* 12, no. 11 (2009): 30- 37.

19. "About ASTM International," *ASTM International*, Accessed 28 Sept 2015, <http://www.astm.org>.

20. For a more detailed description of these properties see: William D. Callister Jr. and David G. Rethwisch, *Fundamentals of Materials Science and Engineering: An Integrated Approach* (Hoboken, NJ: John Wiley & Sons, Inc, 2012).

per unit area before it fractures; tensile strength measures how much stretching stress a material can withstand before it fails; Poisson's ratio is simply the ratio of lateral to axial strain. These properties reflect the resiliency of material to change when different types of stresses are applied.

For example, if you wanted to test the mechanical properties of steel beam you could try to crush the beam (compression test), you could apply a load in the middle of the beam to see how much weight it can support, or you could try to elongate the beam. Materials engineers conduct various tests based on the intended usage of the material. The goal in determining a material's mechanical properties is to simulate the environment in which it will be used in order to learn how those mechanical properties might hold up or degrade over time.

What is important from the perspective of AEC is understanding how these mechanical properties emerge from the atomic structures of materials. For example, for plastic deformation, which is the permanent deformation of a material after release of an applied load, we know that bonds of the atomic structure are broken between neighboring atoms and then reformed with new neighbors.<sup>21</sup> This means atoms have been displaced from their original position to occupy a new position within the material. These new atomic arrangements can result in the loss of the original mechanical properties and the establishment of a new set of mechanical properties; the new properties may not be suitable for the needs of that material.

From a design perspective, it should be obvious that not all atom displacements are equal, and that altering the location of atoms in a large crystal lattice will have different impacts depending on the criticality of those atoms to the overall desired mechanical properties of the material. This is why it is important to study mechanical properties at the atomic scale.<sup>22</sup> For example, mechanical properties are often observed to degrade through "wear and tear." Discovering that a single atomic displacement could be the catalytic event to total system collapse of a particular mechanical property could be

**What is important from the perspective of AEC is understanding how mechanical properties emerge from the atomic structures of materials.**

a major advance in designing materials that withstand wear and tear for much longer. Current research is exploring how certain nanomaterials such as graphene can reduce the wear on materials<sup>23</sup> and how understanding nuclear reactor materials at the atomic scale could lead to stronger, more reliable nuclear infrastructures.<sup>24</sup> If mechanical properties are understood from the bottom up, then the predictive models for failure and additional deg-

21. *Ibid.*

22. Xiadong Han, et al. "In situ atomic scale mechanical microscopy discovering the atomistic mechanisms of plasticity in nano-single crystals and grain rotation in polycrystalline metals," *Ultramicroscopy* 151 (April 2015): 94-100.

23. Evan Lerner, "Nanotech Wear and Tear, Atom by Atom," *University of Pennsylvania*, 4 Feb 2013, <http://www.futurity.org/nanotech-wear-and-tear-atom-by-atom/>.

24. Emmanuelle A. Marquis, "Nuclear reactor materials at the atomic scale," *Materialstoday* 12, no. 11 (2009): 30-37.

radation pathways (such as traditional corrosion) can be made more accurate. These models can then be used to create better, longer lasting materials, and reduce the incidence of unexpected failures.<sup>25</sup>

Technologies such as microelectromechanical systems (MEMS)<sup>26</sup> and nanoelectromechanical systems (NEMS)<sup>27</sup> systems paired with visualization technologies such as the scanning probe microscope<sup>28</sup> allow materials scientists to study the atomic properties of materials more precisely. Materials scientists and engineers thus learn how the atomic properties of materials translate into the micro- and macroproperties of materials.<sup>29</sup> This kind of bottom up understanding can also improve our ability to predict failures.<sup>30</sup> As technology evolves the need for smaller materials on the nano- and microscales is going to increase. MEMS and NEMS will have materials that act as sensors, actuators, electronics, and as structural elements to create the capabilities needed for new technologies. The environmental forces that act on materials at these scales are different, and thus the properties of such materials will be different than the properties observed at the macro scale. The decay, diffusion, or displacement of an atom through some force or process can result in serious consequences to the mechanical properties of materials at much smaller scales. With better bottom-up understanding applied in the design approach, such atomic effects can be predicted and prevented to ensure materials perform reliably and effectively.

### Electrical Properties

The electrical properties of materials depend on their composition and structure.<sup>31</sup> As with other properties, standardized measures are used to describe electrical properties, such as electrical conductivity or resistance.<sup>32</sup> Electrical properties are characteristic of how the material's atoms respond to an applied electric field. An important property for many solid materials is its ability to transfer an electrical current over some distance. This property is described by Ohm's Law, which states that the product of the current ( $I$ ; in Coulombs/second) through a material and the resistance of that material through which the current is passing ( $R$ ; in Ohms) is equal to the applied voltage ( $V$ ; in Joules/Coulomb) causing the current.

$$V = IR$$

From this relationship, it is possible to determine the electrical resistivity and electrical conductivity of a material, both of which depend on the configuration of the underlying

---

25. *Ibid.*

26. "What is MEMS Technology?" *MEMS & Nanotechnology Exchange*, Accessed 30 Aug 2015, <https://www.mems-exchange.org/MEMS/what-is.html>.

27. "Nanoelectromechanical Systems," *Wikipedia*, Modified 1 Sept 2015, Accessed 08 Sept 2015, [https://en.wikipedia.org/wiki/Nanoelectromechanical\\_systems](https://en.wikipedia.org/wiki/Nanoelectromechanical_systems).

28. Sergei V. Kalinin, Sergei, et al, "Nanoscale Electromechanics of Ferroelectric and Biological Systems: A New Dimension in Scanning Probe Microscopy" *Annual Review of Materials Research* 37 (August 2007): 189-238.

29. Andreas Klemenz, et al, "Atomic Scale Mechanisms of Friction Reduction and Wear Protection by Graphen," *Nanoletters* 14, no. 12 (2014): 7145-7152.

30. Mark White and Joseph B. Bernstein, "Microelectronics Reliability: Physics-of-Failure Based Modeling and Lifetime Evaluation," *Jet Propulsion Laboratory* (Feb 2008), [https://nepp.nasa.gov/files/16365/08\\_102\\_4\\_%20JPL\\_White.pdf](https://nepp.nasa.gov/files/16365/08_102_4_%20JPL_White.pdf)

31. D. William, Callister, G. David Rethwisch, *Fundamentals of Materials Science and Engineering: An Integrated Approach* (John Wiley & Sons, Inc, 2012).

32. *Ibid.*

ing atomic structures of the material.<sup>33</sup> As materials move from the nanoscale to the macroscale, like other properties, their electrical properties change because size creates new emergent properties.<sup>34</sup> A simple example is the electrical resistance of a wire: though the same materials are used, a wire with a smaller diameter will have more resistance than a larger wire made of the same material (e.g., copper and other alloyed metals). The electrical parameters of a material like silicon at the macroscale do not predict the electrical properties of a silicon transistor that exists at the nanoscale. In order to properly gauge the electrical properties of a material it is necessary to study these properties on the scales that apply to their specific designs.

Materials are able to conduct electricity because their atomic arrangements allow for the delocalization of electrons.<sup>35</sup> Depending on the type of material, different types of bonding structures hold the material in its particular atomic and electronic geometries. These geometries orient themselves such that the valence electron orbitals are in the most stable configuration according to thermodynamic predictions. Forcing atoms into dense spaces, for example, can lead to the creation of unique orbital configurations that allow for the delocalization of electrons (see figure below).<sup>36</sup>

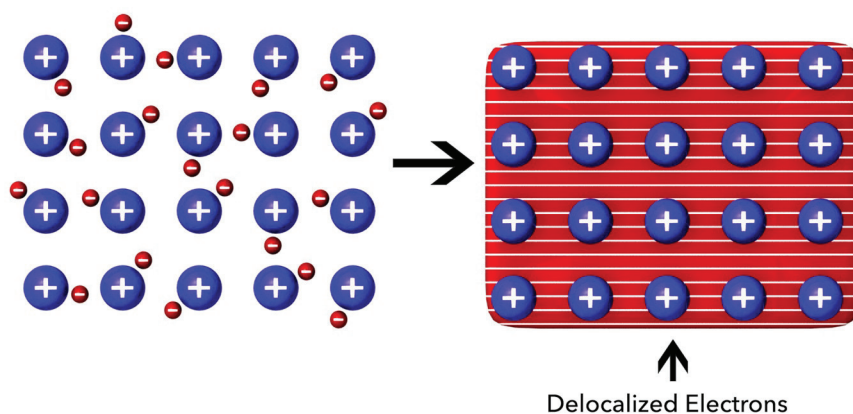

Forcing atoms into dense spaces can lead to the creation of unique orbital configurations that allow for the delocalization of electrons/Alex Taliesen

In metals, the atomic bonding scheme is metallic, which means that there are minimal restrictions to the number and positions of neighboring atoms.<sup>37</sup> Consequently, there are many different packing schemes for metallic crystal structures and each has its own unique properties as a result. Additionally, different metals with the same basic lattice-

33. *Ibid.*

34. "What's So Special about the Nanoscale," *Nano.gov*, Accessed 07 Aug 2015, <http://www.nano.gov/nano-tech-101/special>.

35. D. William, Callister, G. David Rethwisch, *Fundamentals of Materials Science and Engineering: An Integrated Approach* (John Wiley & Sons, Inc, 2012).

36. T.W. Graham Solomons and Craig B. Fryhle, *Organic Chemistry: Eighth Edition* (John Wiley & Sons, Inc.,2004).

37. E. Catherine Housecroft and G. Alan Sharpe, *Inorganic Chemistry* (Pearson Education Limited, 2001).



packing scheme (e.g., face-centered cubic) will have distinct electrical properties due to different atomic properties such as electronegativity. Because the electrical properties of metals depend on the precise arrangement of the crystal structures of the material, any impurities, vacancies, self-interstitial atoms, dislocations, or other types of defects in the lattice structure of a material will alter that material's electrical properties.<sup>38</sup> The smaller the material, the more one of these defects will impact the electrical properties of that material. These defects, for example, change energy band gaps, which are the energy gaps between where an electron is currently occupied in an orbital and the energy it would need to participate in a conduction process.<sup>39</sup>

For materials whose capabilities heavily rely on their ability to conduct, insulate, or partially conduct electricity, ensuring the integrity of the atomic structures is important. For example, microelectronics rely on materials with specific electrical properties that must be stable over time to function effectively. The materials in modern microelectronics are nanomaterials such as transistors or interconnecting wires, which means that even a single-atom change in the atomic structures of these materials can alter their electrical properties, and thus result in loss of designed capability. The gate is a critical component of modern day MOSFET transistors; current gate sizes are less than 22 nm in size.<sup>40</sup> At this scale, the behavior of materials is governed more by quantum mechanical than bulk mechanisms; certain materials, such as the quantum tunneling diode,<sup>41</sup> rely on incredibly fine-tuned band gaps to operate precisely. As technology becomes more dependent on nano- and micromaterials with specific electrical properties, it is becoming imperative to develop new solutions to ensure their integrity in operation. The inner workings of a personal computer are always in a relatively "safe" environment. However, computational technologies are being employed in weapons in much harsher battlefield environments; weapon-control computers are therefore exposed to very different types of stresses than personal laptops.<sup>42</sup>

The basic science underpinning materials' electrical properties is well understood from the atomic scale up. As materials engineers design new materials with unique electrical properties, and these proliferate in technologies with advanced microelectronics, we need to ensure they can function throughout their design life cycles. This will require developing better understanding of how AEC degradation that acts on individual atoms can be mitigated or prevented.

**As technology becomes more dependent on nano- and micromaterials with specific electrical properties, it is becoming imperative to develop new solutions to ensure their integrity in operation.**

38. D. William, Callister, G. David Rethwisch, *Fundamentals of Materials Science and Engineering: An Integrated Approach* (John Wiley & Sons, Inc, 2012).
39. "Band Gap," *Wikipedia*, Modified 29 Aug 2015, Accessed 14 Sept 2015, [https://en.wikipedia.org/wiki/Band\\_gap](https://en.wikipedia.org/wiki/Band_gap).
40. "22 Nanometer," *Wikipedia*, Modified 10 Sept 2015, Accessed 14 Sept 2015, [https://en.wikipedia.org/wiki/22\\_nanometer](https://en.wikipedia.org/wiki/22_nanometer).
41. "Tunnel Diode," *Wikipedia*, Modified 19 Sept 2015, Accessed 15 Sept 2015, [https://en.wikipedia.org/wiki/Tunnel\\_diode](https://en.wikipedia.org/wiki/Tunnel_diode).
42. C. Todd Lopez, "XM25 Counter Defilade Target Engagement System May Lose 'X' by Next August," *USA Army*, 9 Aug 2013, [http://www.army.mil/article/109049/XM25\\_Counter\\_Defilade\\_Target\\_Engagement\\_system\\_may\\_lose\\_X\\_by\\_next\\_August/](http://www.army.mil/article/109049/XM25_Counter_Defilade_Target_Engagement_system_may_lose_X_by_next_August/).

### *Thermal Properties*

Thermal properties refer to how a material responds when heat is applied.<sup>43</sup> These properties are typically described with measures such as heat capacity, coefficient of thermal expansion, thermal stress, and thermal conductivity. Heat is a thermodynamic expression for energy transfer through non-directional mechanisms. Heat's counterpart, work, is the transfer of energy with a vector component, meaning it is typically the flow of energy against or in the direction of an applied field. As materials absorb heat, the overall temperature of the material rises. The energy added to the material can be absorbed to excite vibrational, translational, and electronic energy levels characteristic of the atoms in the material and their bonding scheme. The amount of heat that a material can absorb before the material's temperature rises by a particular unit of temperature is known as the material's heat capacity and is typically expressed in units of J/mol-°K. The heat capacity of a material refers to the tolerance of that material to added heat. High heat capacities (e.g., silica molar heat capacity = 42.2 J/mol-°K)<sup>44</sup> mean the material can absorb a lot of heat before the temperature of the material begins to rise; the opposite is true for low heat capacity materials.

One of the reasons the temperature rises in heated materials is because the added heat causes the atoms within the material's crystal lattice to vibrate more. The science that describes this phenomenon is quantum mechanics.<sup>45</sup> All atoms in any lattice structure regardless of composition are vibrating at high frequencies with low amplitudes. This is the reason instruments such as infrared (IR)-spectrometers can identify various functional groups within molecules.<sup>46</sup> This instrument detects these vibrational, rotational, and translational frequencies, and a trained chemist can discern the various functional groups based on the spectra produced from the spectrometer. The vibration of atoms in a material causes them to radiate heat. If something is room temperature, it means that the atoms have reached thermal equilibrium with the room, and are vibrating such that heat they give off is equal to the heat they are absorbing. Added heat causes the vibrations to increase, or occur faster, leading to more heat being given off and the temperature of the material rising. It is important to realize that these are not random, but coordinated, vibrations in a material such that the lattice vibration is almost wave-like (i.e., as phonons; see figure on page 99). As the vibrations become more intense, the material begins to experience more stress to its underlying lattice structure. When the added heat becomes too great, the lattice can begin to slip or fall apart.<sup>47</sup>

---

43. D. William Callister, G. David Rethwisch, *Fundamentals of Materials Science and Engineering: An Integrated Approach* (John Wiley & Sons, Inc, 2012).

44. "Heat Capacity," *Wikipedia*, Modified 17 Sept 2015, Accessed 20 Sept 2015, [https://en.wikipedia.org/wiki/Heat\\_capacity](https://en.wikipedia.org/wiki/Heat_capacity).

45. Thomas Engel and Philip Ried, *Physical Chemistry* (Pearson Education, Inc. 2006).

46. *Ibid.*

47. Dragica Vasileska, Katerina Raleva, and Stephen M. Goodnick, "Heating Effects in Nanoscale Devices," <http://cdn.intechopen.com/pdfs-wm/10114.pdf>

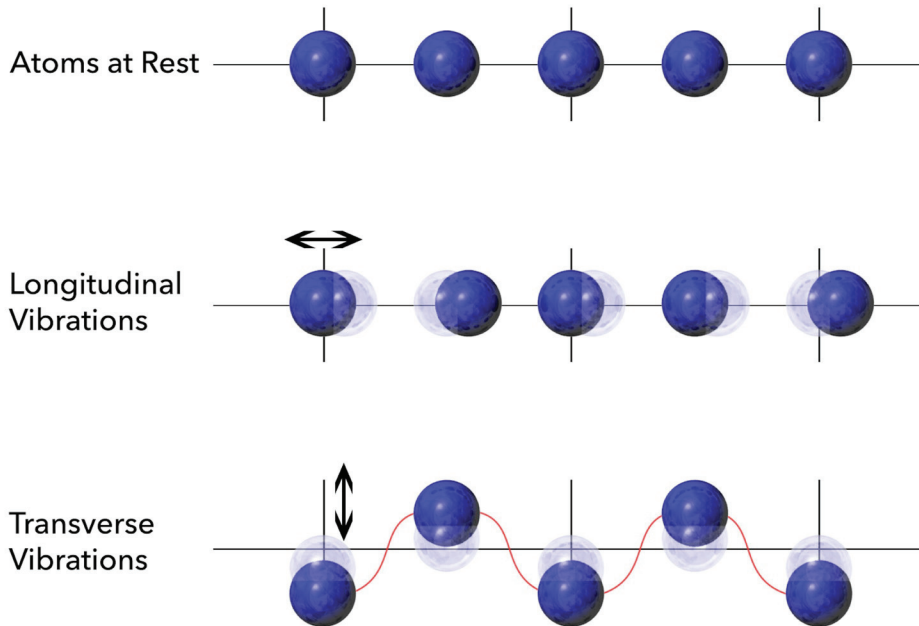

Vibrations of atoms/Alex Taliesen

The ability of a material to maintain its structure upon the addition of heat is dependent on the composition and atomic structure of that material. These two factors are responsible for the micro and macro properties observed as materials are scaled up from the atomic level. In addition to potentially melting, most materials expand upon the addition of heat because the spacing between atoms in the lattice structures gets larger.<sup>48</sup> This occurs because the added heat increases the vibrational energies of those atoms. For each type of material, the greater atomic bonding energy associated with its atomic structure will give rise to an increase in interatomic separation for a particular rise in temperature. The continued heating and cooling of a material can, therefore, result in mechanical stresses being applied to the material. These stresses can create the same types of defects normally associated with mechanical stress. The continued thermal expansion and contraction of a material can cause that material to warp, fracture, or elongate.

The response of a material to applied heat can also be similar to what is observed when an electric field is applied to a material. Materials can transfer heat through bond vibrations or through the transfer of electrons. The size of the material affects the impact

48. D. William, Callister, G. David Rethwisch, *Fundamentals of Materials Science and Engineering: An Integrated Approach* (John Wiley & Sons, Inc, 2012).

that single atomic changes (for example, transfer of an electron) will have. Scientists and engineers use knowledge of how the atomic underpinnings of a material lead to its thermal properties to design materials with improved capabilities. Knowing how environmental heat cycles can accelerate mechanisms such as decay, diffusion, displacement or other atomic changes will become increasingly important as we design smaller-scale technologies such as nanomaterials.

### *Magnetic Properties*

Magnetic properties refer to the response of material when subjected to an applied magnetic field. Certain materials exhibit magnetic properties regardless of whether or not a magnetic field is applied. These properties are described and measured in terms such as magnetization, magnetic flux density, and permeability. Magnetic properties are a consequence of the composition of the atom.<sup>49</sup> Magnetic fields arise when charged particles move through space, so in an atom an electron can generate two potential magnetic fields, as shown in the figure, page 101. Because the electron is charged and orbiting the nucleus (note that the descriptions in this paragraph are simplifications; the actual behavior is more complex at the quantum mechanical level)<sup>50</sup> it can be thought of as a small current loop that creates a very small magnetic field in which the magnetic moment is oriented along its axis of rotation. Additionally, each electron spins around its own axis, so this magnetic moment is directed along the corresponding spin axis. An easy comparison is to imagine the earth is an electron and the sun the nucleus. The earth revolves (spins) around the sun creating a magnetic moment, and the earth also rotates (spins) on its own axis creating another, different magnetic moment. Every electron in an atom acts like a small magnet: each electron has both a permanent orbital and spin magnetic moments.<sup>51</sup>

Magnetic moments from electrons in an atom tend to cancel: every spin “up” that is paired with a spin “down” electron cancels the pair’s net magnetic moment. The same is true for orbital moments. An atom’s net magnetic moment is the sum of the orbital and spin magnetic moments of all its electrons; pair cancellations reduce the overall net moment. Thus, different magnetic properties will manifest depending on the electron configurations of atoms. Furthermore, as atoms form molecules or become parts of larger aggregate structures, such as in a crystal lattice, new magnetic properties characterize those structures.<sup>52</sup> This gives rise to the phenomena of diamagnetism, paramagnetism, ferromagnetism, antiferromagnetism, and ferrimagnetism.<sup>53</sup>

---

49. Thomas Engel and Philip Ried, *Physical Chemistry* (Pearson Education, Inc. 2006).

50. “Bohr-van Leeuwen Theorem,” *Wikipedia*, Modified 3 Jan 2015, Accessed 18 Sept 2015, [https://en.wikipedia.org/wiki/Bohr-van\\_Leeuwen\\_theorem](https://en.wikipedia.org/wiki/Bohr-van_Leeuwen_theorem).

51. “Spin Magnetic Moment,” *Physics Forums*, 2 Oct 2014, <https://www.physicsforums.com/threads/spin-magnetic-moment.773970/>.

52. Robin F.C. Farrow, et al. *Magnetism and Structure in Systems of Reduced Dimension*, (Plenum Press, NY: 1993).

53. “Magnetism,” *Wikipedia*, Modified 10 Sept 2015, Accessed 28 Sept 2015, <https://en.wikipedia.org/wiki/Magnetism>.

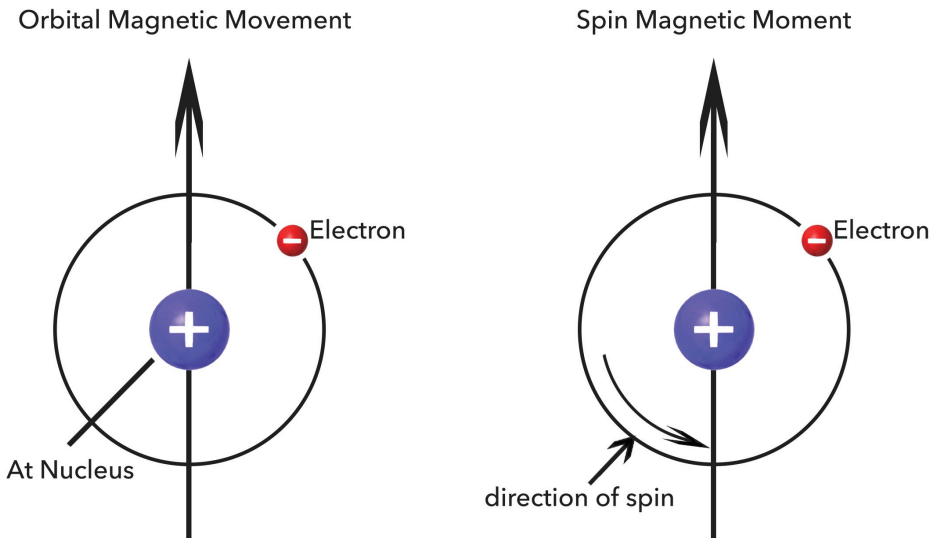

Magnetic moments from orbital movement and spin/Alex Taliesen

At the micro scale, structures known as magnetic domains exist. Regardless of whether or not the material has a permanent magnetic dipole, the various domains of the microstructure can be aligned differently, and this alters the magnetic properties of the material.<sup>54</sup> An applied field can align the domains. How strong the field needs to be in order to achieve alignment is a function of the magnetic properties of the particular material. This property is important in the function of devices such as soft magnets because the applied field might reorient the domains with little heat loss. Hard magnets, on the other hand, require much stronger fields and when their domains are reoriented there is greater heat loss. For these reasons, materials with either soft or hard magnetic properties are selected for specific purposes.

Magnetic properties are utilized in microelectronics for information storage.<sup>55</sup> In hard disk drives or magnetic tapes, information is stored by creating unique patterns of magnetized grains in materials such as cobalt-chromium alloy. Storage typically requires a common magnetization of about 100 grains.<sup>56</sup> This encompasses many atoms, but technology advances are making it possible to store information on structures that are smaller.<sup>57</sup>

54. D. William, Callister, G. David Rethwisch, *Fundamentals of Materials Science and Engineering: An Integrated Approach* (John Wiley & Sons, Inc, 2012).
55. "Magnetic Storage," *Wikipedia*, Modified 12 Sept 2015, Accessed 24 Sept 2015, [https://en.wikipedia.org/wiki/Magnetic\\_storage](https://en.wikipedia.org/wiki/Magnetic_storage).
56. D. William, Callister, G. David Rethwisch, *Fundamentals of Materials Science and Engineering: An Integrated Approach* (John Wiley & Sons, Inc, 2012).
57. Hua Yuan and Davide E. Laughlin, "Grain Size Reduction for Perpendicular Magnetic Recording Media Using an Ar-ion Etched Ru Seedlayer," *Applied Physics Letters* 93 (2008).

The smaller these structures get, the more sensitive they will become to changes in the underlying atomic structures of the materials that make up the storage medium. The magnetic properties of materials thus play an important part in the electronics domain, as well as other domains where electronic information needs to be safely and permanently stored.

Understanding the impact changes in the atomic structures and composition might have on these properties is critical in ensuring the reliability of designs using magnetic materials.

**Understanding the impact changes in the atomic structures and composition might have is critical in ensuring the reliability of designs using magnetic materials.**

Ferrimagnetic materials typically rely on unique configurations of atoms to ensure a net magnetic moment and lower cancellations. The degradation of materials through atomic effects can change such configurations, and potentially result in the failure of that material. Materials exist today for which magnetic properties at the nanoscale are important; the use of such materials is going to increase in the future. Understanding the degradation that can occur through AEC will be key in ensuring these existing materials are reliable.<sup>58</sup>

### *Optical Properties*

Optical properties of materials are those that cause a material's property to change due to interaction with electromagnetic radiation, or cause electromagnetic radiation to change upon interaction with the material in the "light" regions of the electromagnetic spectrum (infrared, visible, ultraviolet). If a material has optical properties it means it can alter, be altered, or do both upon interacting with electromagnetic radiation. The ability of a material to reflect, refract, absorb, transmit, or change via interaction with electromagnetic radiation depends on the composition and atomic crystal lattice structure of a material. The particular nature of the lattice and the atoms, ions or molecules contained within it will determine the various quantized energy levels for the matter's ability to interact with light.<sup>59</sup> When absorption occurs, it is because an electron has absorbed the energy of a photon that is equal the energy difference between its ground state and a quantized excited state. When light passes through a material it is because it did not contain the right energy needed to match the ground to excited state energy band gap. The type of atom and its atomic configuration determines these quantized energy levels for the optical properties of materials.

Metals are for essentially opaque to all electromagnetic radiation on the low end of the electromagnetic spectrum and transparent to high frequency radiation such as gamma. Metals are able to absorb most photons in the regions of the electromagnetic spectrum called "light" because of the wide range of excitable electron energy states they

---

58. Pui-Wa Ma, C. H. Woo, and S.L. Dudarev, "Spin-Lattice Dynamics Simulations of Ferromagnetic Iron," *Physics Review* 85, No.18 (1 May 2012).

59. Thomas Engel and Philip Ried, *Physical Chemistry* (Pearson Education, Inc. 2006).

have available. Changes to the atomic structures of metals that alter the energy band gaps for absorption change their optical properties. Most metals are highly reflective; their ability to reflect light with nearly the same frequency and number of photons as the incident light is an important property for systems designed to transmit light. Non-metals tend to be more transparent to light due to the nature of their energy band distributions. Thus, materials containing non-metals absorb, reflect and transmit light differently.

Optical phenomena are important to materials scientists and engineers looking to create new technologies.<sup>60</sup> The concept of photoconductivity combines knowledge of the atomic properties of materials such as semiconductors with the knowledge of how electromagnetic radiation can change those properties to create technologies like the solar cells.<sup>61</sup> Understanding the electroluminescence properties of materials allows for the development and use of light emitting diodes.

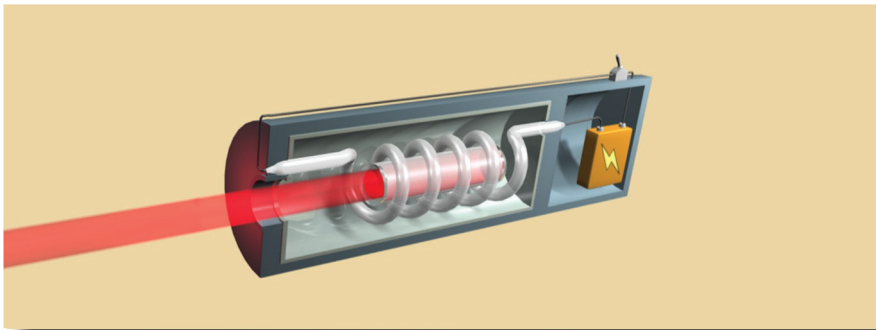

Red Ruby laser/Mcgill

The rubies we use in lasers are a ceramic composed of sapphire ( $\text{Al}_2\text{O}_3$ ) and around 0.05%  $\text{Cr}^{3+}$  ions. Doping sapphire with chromium +3 ions provides specific electron states to the ruby lattice that are critical to its ability to act as a laser (see Figure 7).<sup>62</sup> Once the ruby laser has been appropriately processed, the excitation of electrons within the ruby lattice is achieved via a xenon flash lamp. At that point, two things happen: Some  $\text{Cr}^{3+}$  electrons get excited and decay back directly to their ground state, and some  $\text{Cr}^{3+}$  electrons decay to a metastable state that exists for approximately 3 ms. The result is that many electrons in the ruby occupy this metastable state simultaneously.<sup>63</sup> This metastable state eventually avalanches, and due to the design of the apparatus containing the ruby rod crystal, results in the emission of a high-intensity, coherent laser light beam. There are many other types of materials used for lasers, and the same principles apply. Such technologies rely heavily on the precise nature of the atomic lattice structures of materials to provide useful optic properties.

- 
60. D. William, Callister, G. David Rethwisch, *Fundamentals of Materials Science and Engineering: An Integrated Approach* (John Wiley & Sons, Inc, 2012).
  61. Marco M. Furchi, et al., "Mechanisms of Photoconductivity in Atomically Thin  $\text{MoS}_2$ ," *NanoLetters* 14, no. 11 (2014): 6165-6170.
  62. D. William, Callister, G. David Rethwisch, *Fundamentals of Materials Science and Engineering: An Integrated Approach* (John Wiley & Sons, Inc, 2012).
  63. *Ibid.*

Changes to the atomic lattice structures of materials used for their optical properties can be impacted by AEC. Optical properties are a consequence of quantum mechanical phenomena that depend on the atoms and their atomic configurations that make up a material. Many optical properties that require absorption depend on specific energy band gaps that exist between ground state electrons and unoccupied atomic/molecular orbitals within the material. AEC can directly impair such energy band gaps through disruption of the crystal lattice. AEC can also accelerate the degradation of optical properties by acting as a catalyst for the loss of order within a structure (e.g., help catalyze diffusion).

## METALS

### *Basics of Metals*

Metals make up the majority of the elements on the periodic table (see figure page 105).<sup>64</sup> The alkali earth metals are found in columns IA and IIA on the table. The electron configuration for these elements puts the valence electrons in an s-orbital at one energy level higher than the last full valence shell. The chemical properties of these elements reflect this situation, and they often ionize to take on noble gas electron configurations. This allows them to form stable salts with non-metals in columns VIA and VIIA.

The transition metals and the metals/metalloids in columns IIIA and IVA are also important materials. The transition metals' electron configurations put their valence electrons into a d-orbital, and the chemical properties of the transition metals reflect this valence structure. Transition metals are good conductors because the valence d-electrons are loosely bound, making it easier for the electrons to delocalize. For the same reason these metals have low ionization energies in general, allowing them to take on multiple oxidation states relatively easily.<sup>65</sup> They are generally electropositive, meaning willing to give up electrons. This ability allows them to form a range of ionic or partially ionic compounds. Most of the transition metals mix well because they all have similar atomic sizes (although relatively large) making it easier to replace one another in a crystal lattice.

When pure metals are mixed with another metal or non-metal they are called alloys, and experience different properties than pure metals – the periodic table shows some of the properties of metals and non-metals. Brass is a mixture of copper (Cu) and zinc (Zn) for example. Metals typically pack into high densities, are malleable, and ductile. They exhibit different levels of strength, hardness, and other mechanical properties. The transition metals experience a range of magnetic properties due to the nature of their available valence structures. Most metals are optically reflective. Certain metals

---

64. Steven S. Zumdahl and Susan A. Zumdahl, *Chemistry: Fifth Edition* (Houghton Mifflin Company, 2000).

65. *Ibid.*



 Periodic Table Of Elements

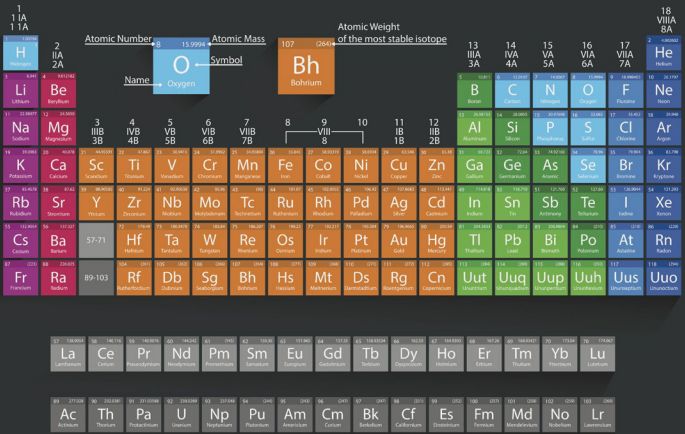

The periodic table displays elements from Hydrogen (H) to Oganesson (Og). Callouts for Oxygen (O) and Bohrium (Bh) are shown. Oxygen has an atomic number of 8, symbol O, and an atomic mass of 15.999. Bohrium has an atomic number of 107, symbol Bh, and an atomic mass of 264.

Alkali Metal   Alkaline Earth   Transition Metal   Basic Metal   Semimetals   Nonmetals   Halogens   Noble Gas   Lanthanides   Actinides

Maximilian Laschon/www.shutterstock.com

Periodic Table of Elements

exhibit totally different properties simply because the particular temperature and pressure favors one crystal structure over another. Gray and white tin are an example of this phenomenon. A major problem with the transition metals from a material sustainment standpoint is that they easily oxidize, or corrode. Thus, if metals are needed in their pure form or in a particular oxidation state that is not their highest oxidation state, materials engineers have to take precautions to achieve the desired form or state.

The electron configuration of the metals and metalloids of columns IIIA and IVA have their valence electrons in a p-orbital. Due to the nature of these valence structures, these metals tend to display intermediate properties between metals and non-metals, depending on the specific configurations of their valence electron structure. In general, though, they exhibit many of the same properties as transition metals. Table 2, page 106 contrasts metal and non-metal properties.

Table 2: Metal and non-metal properties.\*

PROPERTY	METALS	NONMETALS
Appearance	Shiny	Dull
Density	High (metals feel heavy for their size)	Low (metals feel heavy for their size)
Strength	Strong	Weak
Pliability	Pliable	Brittle
Ductility	Ductile	Not ductile
Electrical conductivity	Good	Poor
Heat conductivity	Good	Poor

\*"Metals v non-metals," BBC, 2014, Accessed 30 Oct 2015.

## Structures

Metals are crystalline materials, meaning that they are solid and exhibit order over a wide range of atoms.<sup>66</sup> Consequently, solid metals are arranged in repetitive three-dimensional patterns in which each atom is bonded to its nearest neighbors. Any material that does not form such regular order can be either non-crystalline or amorphous: in these materials, without the ordered arrangement of atoms, there is no underlying atomic structure to create a solid material. Some pure metals actually arrange themselves into more than one ordered arrangement depending on temperature and pressure; these are known as allotropes. The particular arrangement of atoms in a metal crystal lattice gives the material specific properties that can vary dramatically with scale.<sup>67</sup>

The crystal lattice structures of most metals are described using an atomic hard-sphere model where atoms (or ions) are considered to be spheres that touch their nearest neighbor atom.<sup>68</sup> Within any lattice structure there is a repeating unit of symmetry known as the unit cell. For most crystal structures, parallelepipeds are used to describe the unit cell. The properties of a unit cell help explain why other properties of a material manifest.<sup>69</sup> For example, closed-packed crystal structures are able to form denser materials than body-centered cubic structures. Understanding the relationship between a material's lattice structure and its properties can help explain why impurities that distort the lattice structure lead to changes in the material's properties. To determine the impact of AEC, then, it is necessary to understand the connection between the crystal lattice structure of a material and the properties it displays.

66. E. Catherine Housecroft, and G. Alan Sharpe, *Inorganic Chemistry* (Pearson Education Limited, 2001).

67. *Ibid.*

68. *Ibid.*

69. *Ibid.*

Metals such as gold, lead, aluminum, copper and silver all tend to be found in face-centered cubic geometries with atoms located at the corners of the lattice and the centers of each face on the cube, as shown in the figure to the right. This type of lattice has a coordination number of 12 (one atom sees 12 other atoms) and an atomic packing factor of 0.74. The atomic packing factor is the ratio of the volume of atoms in a unit cell to the total unit cell volume.<sup>70</sup> This represents the maximum packing possible for spheres of the same diameter in a particular lattice configuration. These dense packing patterns make it easier for metals to facilitate the delocalization of electrons that gives these metals their excellent conductive properties and also provides shielding for their nuclei.

Chromium, iron, tungsten, and molybdenum tend to pack in what is known as body-centered cubic crystal structure. For this type of packing, there are atoms at each of the eight corners of the cubic structure and a single atom in the center. This gives a coordination number of 8 and an atomic packing factor of 0.68, less than the face-centered cubic crystal structure.<sup>71</sup> This type of packing tends to be the favored packing style for metals at high temperatures, even when the cooler temperature style is close-packed. This packing style tends to lead to harder microstructures and macrostructures, that are less malleable than close-packed metals.

The last common type of unit cell packing is the hexagonal close-packed, shown in the figure. Metals such as cobalt, titanium, zinc, and cadmium tend to pack this way. This packing, although not cubic, gives the same coordination number (12) and atomic packing factor (0.74) as the face-centered cubic structure.<sup>72</sup>

These lattice structures represent the atomic arrangements of pure metals and are good approximations of the actual packing patterns. Their packing structures are key determinants of many mechanical, electrical, thermal, magnetic, optical, and deteriorative properties observed in metals. Mechanical engineers understand the importance of these lattice structures and their relationships to micro and macro material properties. By manipulating these structures through the introduction of impurities, material properties can be fine tuned for specific needs. In the same way, a material's property, especially at the nanoscale, can be fundamentally altered by atomic effects. An

Examples of crystal lattice structures.

Cubic Face Centered (fcc)

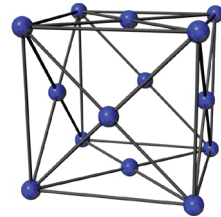

Al, Ni, Ag, Cu, Au

Cubic Body Centered (bcc)

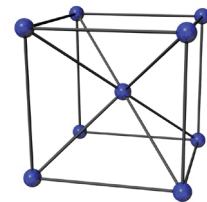

Fe, V, Nb, Cr

Hexagonal

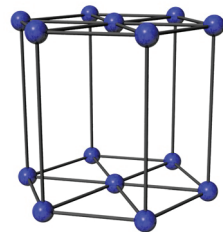

Ti, Zn, Mg, Cd

Image Credit:  
Alex Taliesen

70. D. William, Callister, G. David Rethwisch, *Fundamentals of Materials Science and Engineering: An Integrated Approach* (John Wiley & Sons, Inc, 2012).

71. *Ibid.*

72. D. William, Callister, G. David Rethwisch, *Fundamentals of Materials Science and Engineering: An Integrated Approach* (John Wiley & Sons, Inc, 2012).

atomic interaction that fundamentally alters the state, composition, or position of a single atom in lattice can have significantly greater impact<sup>73</sup> than a single or small-number event in bulk materials.

Packing structures also give rise to single crystal or polycrystalline micro- and macrostructures. Single crystals are critical to modern technologies such as microelectronics, where single crystals of silicon and other semiconductors are utilized. In a single crystal, all the unit cells are interlocked so as to be in the same orientation, and thus the arrangement of atoms is repeated throughout the crystal. Current bottom-up approaches to building some nanomaterials are designed to build perfect single crystals to support the development of advanced technologies.<sup>74</sup>

Although single crystals can be found in nature, most crystals are termed polycrystalline, meaning they are the combination of two or more small crystals that joined during solidification. The consequence is that the material becomes made up of specific domains called grains, and these grains are separated by a grain boundary.<sup>75</sup> Within each grain it appears as though the atoms are arranged in a single crystal, but at the grain boundary, this order is lost. These grain boundaries are important factors in determining the properties of a material and the potential ways it might degrade<sup>76</sup> In a sense, these boundaries are "chinks" in the material's "armor." Certain atomic effects that lead to this displacement of atoms at the grain boundary may facilitate or catalyze unique phenomena like the initiation of tin whiskers in microelectronics (according to the electrostatic theory for tin whiskers).<sup>77</sup> We need better understanding of the atomic structure at these grain boundaries, and how atomic effects change the atomic structure at grain boundaries, to develop better designs and corrosion preventative measures for metals.

### *Specific Metals and Their Properties*

Metals exhibit a wide range of properties and have many different uses. A thorough discussion of every metal of interest is well beyond the purpose of this work; that level of comprehensive treatment is contained in material science textbooks. In this section, we use an exemplar to explain the scientific rationale for the importance of AEC. To illustrate the point, we have chosen steels: metals that are essentially ubiquitous in society and familiar to virtually everyone. Classifications of steel alloys are depicted in Figure 11. The point we will demonstrate is that materials are impacted by AEC, AEC affects the material properties of their underlying atomic structures, and at smaller scales a few AEC events can have an observable deleterious impact.

- 
73. Emmanuelle A. Marquis, et al., "Nuclear reactor materials at the atomic scale," *Materialstoday* 12, No.11 (2009): 30-37.
  74. J. Marc Madou, *Fundamentals of Microfabrication and Nanotechnology Volume 11: Manufacturing Techniques for Microfabrication and Nanotechnology. 3rd Edition* (CRC Press, 2011).
  75. Pavel Lejeck, *Grain Boundary Segregation in Metals* (Springer, 2010).
  76. M. Gerbig, et al., "Atomic-Scale Quantification of Grain Boundary Segregation in Nanocrystalline Material," *Physical Letters Review* 112, No.12 (2014).
  77. Victor Karpov, "Electrostatic Theory of Metal Whiskers," *Physics Review Applied* 1, No.4 (2014).

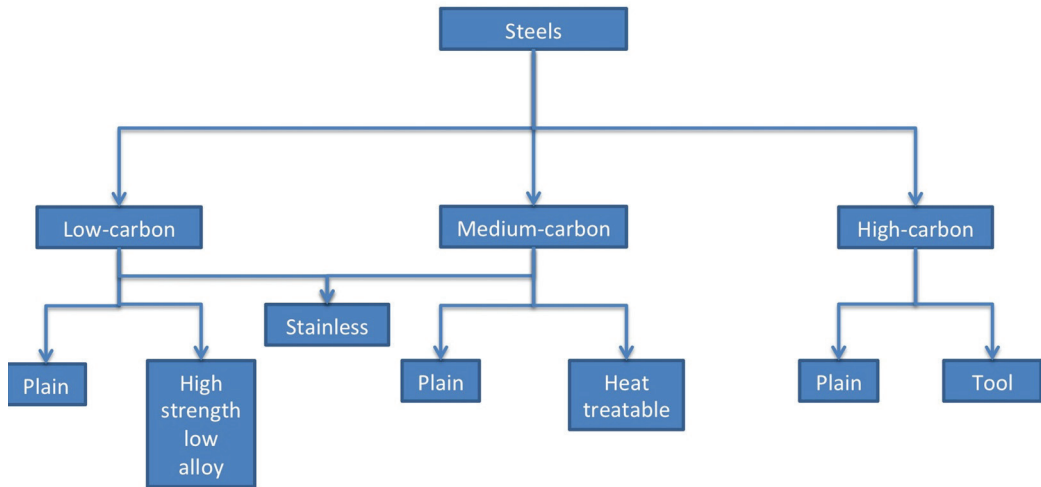

Classifications of steel alloys.

### Ferrous Alloy Steels

An alloy is a combination of two or more metals; some alloys are comprised of a metal with a non-metal impurity. The ferrous alloys, which are alloys in which the primary component is iron, are the most manufactured type of alloy today.<sup>78</sup> Iron is abundant in the earth's crust, is easy to work with, and is versatile; depending on the alloy, designers can achieve a wide range of mechanical and physical properties. A major problem with ferrous alloys, though, is that the iron atoms undergo oxidation easily in the presence of a strong oxidizing agent such as oxygen. Everyone is familiar with the result, which we call rust.

Steels are a mixture of iron with different concentrations of carbon.<sup>79</sup> There are low, medium, and high-carbon steels, each of which displays unique properties. In addition to carbon, in certain alloy steels, impurities (such as low concentrations of manganese) are added purposefully to create unique properties. In current steel manufacturing processes, getting the right combination of ingredients combines both art and science. The techniques rely on an empirical approach to engineer these alloys, and then reproduce those that have been proven to work.<sup>80</sup> To date, it has not been possible to obtain the exact same atomic configurations of iron and its impurities in the production of steel. If we can determine how to manufacture materials atom-by-atom, that may change.

78. "Ferrous Metals and Iron Alloys Information," *HIS Engineering*, Accessed 21 Sept, 2015, [http://www.globalspec.com/learnmore/materials\\_chemicals\\_adhesives/metals\\_alloys/ferrous\\_metals\\_iron\\_alloy](http://www.globalspec.com/learnmore/materials_chemicals_adhesives/metals_alloys/ferrous_metals_iron_alloy).

79. "Steel," *Wikipedia*, Modified 22 Sept 2015, Accessed 24 Sept 2015, <https://en.wikipedia.org/wiki/Steel>.

80. Stephen D. Cramer, ed., *ASM Handbook Volume 13C: Corrosion Environments and Industries* (ASM International, 2006).

Low-carbon steels generally contain around 0.25% (by weight) of carbon; the microstructures of these steels typically consist of ferrite and pearlite. Ferrite has a body-centered cubic crystal structure, while pearlite is a mixture between cementite (a face-centered cubic crystal structure) and ferrite.<sup>81</sup> Low-carbon steels are the most highly produced steels; despite being relatively weak and soft, they are extremely ductile, tough, malleable, and inexpensive to produce. These types of steels are found in numerous applications such as automobiles, structural beams (i.e., I-beams), pipelines, buildings and bridges. These steels can be made into what are called "high-strength, low-alloy" steels through the addition of copper, vanadium, nickel, and molybdenum to add strength.<sup>82</sup>

Medium-carbon steels contain between 0.25% and 0.6% (by weight) of carbon. These steels have microstructures of tempered martensite, in which the iron atoms pack into a close-packed structure. The mechanical and thermal properties of these steels can be adjusted through the additions of alloying agents such as chromium, nickel, and molybdenum. As a result of their increased strength, these steels are less ductile but are very tough. Typical uses of medium-carbon steels involve crankshafts, railway car wheels, and other applications requiring materials with high strength and wear resistance.

High-carbon steels contain between 0.6% and 1.4% (by weight) of carbon and have microstructures that are entirely pearlite,<sup>83</sup> thus giving their atomic structures a face-centered cubic crystal lattice. These are the hardest and strongest types of steels, which means they are also the least ductile. The increased strength and hardness results in improved thermal and mechanical properties: they are more heat resistant than other carbon steels and less susceptible to wear. For example, high-carbon steel knives can hold a sharp edge longer than medium- or low-carbon knives. High-carbon steels can also be made harder and more wear resistant by adding chromium, vanadium, tungsten, and molybdenum into the mixture. These kinds of steels are used for tools, blades, springs, and high-strength wire.

The different carbon steels are all susceptible to classical corrosion, but there is a fourth class of carbon steel that is much more resistant to these effects: stainless steel. Stainless steels are low-carbon steels with a high concentration of chromium added (at least 11% by weight), along with other elements such as nickel and molybdenum. The specific mixes depend on the desired application. Stainless steels can be manufactured to have predominately three different microstructures: martensite, ferrite, or austenite. Their different microstructures give the stainless steels the different thermal and mechanical properties needed for different applications.<sup>84</sup> Of all stainless steels, the austenite is the most corrosion resistant, but austenite steels lack the magnetic properties that the ferrite and martensite derivatives have. Stainless steels have a wide array of applications, including gas turbines, aircraft, missiles, nuclear power-generating units, and heat-treating furnaces.

---

81. D. William, Callister, G. David Rethwisch, *Fundamentals of Materials Science and Engineering: An Integrated Approach* (John Wiley & Sons, Inc, 2012).

82. "High-Strength Low-Alloy Steel," *Wikipedia*, Modified 25 May 2015, Accessed 24 Sept 2015, [https://en.wikipedia.org/wiki/High-strength\\_low-alloy\\_steel](https://en.wikipedia.org/wiki/High-strength_low-alloy_steel).

83. "High-Carbon Steels: Full Pearlitic Microstructures and Applications," *ASM International* (2005): 281- 295.

84. Wei Sha, and Zhanli Guo, *Maraging steels: Modeling of microstructure properties and applications* (Woodhead Publishing, 26 Oct 2009).



Microscopic structure of steel/Webcorr

Steels are not single crystals; they are characterized by polycrystalline microstructures. As a result, all steels consist of various grains and corresponding grain boundaries (see figure above). The grain boundaries reflect areas with lattice defects, and such defects include vacancies (an iron atom is missing from a lattice point) and dislocations (linear defects in the lattice). The atoms in metal lattice structures have a tendency to diffuse, and the vacancies act as a diffusion facilitator because they represent areas of “low concentration.”<sup>85</sup> AEC can facilitate the displacement of atoms at any point in a particular microstructure of steel, but those that occur at grain boundaries are the most significant. Because AEC can create vacancies within a lattice, AEC can initiate diffusion that might not have taken place in the absence of the atomic effect. When such steels are used on the micro- or nanoscale, these effects can have much greater impacts on the rate of degradation of the steel material through other, more classical mechanisms of corrosion. Recent insights into the impact of AEC on materials such as steel in environments such as nuclear power plants have revealed the importance of understanding how AEC mechanisms accelerate the degradation of macroscopic properties.<sup>86</sup>

In polycrystalline metallic materials, the smaller the grain size, the smaller the grain boundary, and therefore the more strength and toughness the metal will have. This phenomenon illustrates the importance of creating small grains when producing steels. Even so, the nature of typical high-energy AEC processes can have important impacts: by causing corrosion at grain boundaries, AEC may create the first crack in a lattice, thereby creating a grain boundary where was none. Limited study of atomic effects on materials such as steels has been completed because steel use typically occurs at

85. D. William, Callister, G. David Rethwisch, *Fundamentals of Materials Science and Engineering: An Integrated Approach* (John Wiley & Sons, Inc, 2012).

86. Emmanuelle A. Marquis, et al., “Nuclear reactor materials at the atomic scale,” *Materialstoday* 12, No.11 (2009): 30-37.

the macroscale, so many AEC events would have to occur before noticeable impacts arise. If, on the other hand, we better understood AEC effects, it might be possible to improve lifetimes and reliabilities by designing ways to reduce their negative impacts<sup>87</sup>. As technology development reaches into smaller scales, fewer AEC events are needed to cause an observable impact.

## CERAMICS

### *Basics of Ceramics*

Ceramics are compounds of metals and inorganic non-metals. Unlike metals, which develop their atomic, micro, and macro properties through the various structures and chemistries possible as a result of metallic bonding, ceramics develop their properties through a range of bonding schemes<sup>88</sup>. Ceramics form their structures and develop their properties through a combination of ionic, covalent, and secondary bonding (e.g., dipole interactions) mechanisms. The phenomena that must occur in order to create the fundamental properties of ceramics were poorly understood for most of humanity's experience with them. Ceramics got their name from the Greek word *keramikos*, which roughly translates into "burnt stuff." This name was associated with the fact that ceramics were made from heating substances such as clay to very high temperatures (i.e., firing). The solidification process that occurs after heating ceramics to such high temperatures allows the ceramic molecules and ions to crystallize into the atomic configurations that give them their unique properties.<sup>89</sup> Ceramic crystal structures are held together by ionic and/or covalent bonds and are less prone to deformation: generally, fracture occurs before deformation.<sup>90</sup> In part, the reason ceramics are so brittle compared to a metal is because unlike metallic bonds, ionic and covalent bonds don't "bend."

The metals in ceramics are described in the previous section. The non-metals are located in columns IVA, VA, VIA, and VIIA of the periodic table (refer to the Periodic Table on page 105 for specific elements in these columns). Non-metals tend to have electronegative atoms, and they tend to participate in chemical and physical phenomena that increase the density of electrons surrounding their nuclei. This contrasts to most metals that are more electropositive, and therefore less "needy" when it comes to particular electron density requirements. The electronegativity property of non-metals is related to the fact their valence electron orbitals are at a point where it is more energetically favorable to acquire electrons to fill their valence shells, rather than give them up, as many metals do. Thus, these atoms tend to involve themselves in bonding schemes that give them the desired "octet" in the s and p orbitals of their highest valence shell.<sup>91</sup> For example, nitro-

87. *Ibid.*

88. D. William, Callister, G. David Rethwisch, *Fundamentals of Materials Science and Engineering: An Integrated Approach* (John Wiley & Sons, Inc, 2012).

89. "Scientific Principles," *University of Illinois*, Accessed 14 Sept 2015, <http://matse1.matse.illinois.edu/ceramics/prin.html>.

90. *Introduction to Materials Science*, Chapter 13, Structure and Properties of Ceramics, <http://web.utk.edu/~prack/mse201/Chapter%2013%20Structures%20and%20Properties%20of%20Ceramics.pdf>.

91. E. Catherine Housecroft and G. Alan Sharpe, *Inorganic Chemistry* (Pearson Education Limited, 2001).



gen tends to orient itself into geometries that favor three covalent bonds, oxygen tends to favor two, and the halogens only desire a single covalent bond. Complex electronic geometries are possible with non-metals. Halogens only need one bond because they only need a single electron to complete their octet. The other 3 electron pairs (i.e., lone pairs) occupy unique electronic geometries that allow them to take on various geospatial shapes. For the second energy level, for example, these typically consist of tetrahedral geometries. At the third energy level, the unoccupied d orbitals become important, and atoms can in certain circumstances surround themselves with more than eight valence electrons. The Valence Shell Electron Pair Repulsion (VSEPR) theory describes the types of possible electronic geometries possible with the non-metals that participate in covalent bonds.<sup>92</sup> The figure on page 114 shows the various electronic bond geometries that are possible.

The unique atomic properties of the types of atoms that make up the class of materials called ceramics explain why the structures of ceramics are more complex than those of metals. With structures dependent on bonds dedicated to strict sharing (i.e., no delocalization) of electrons, ceramics tend to make excellent insulators. Certain ceramics are able to take on a mixed property of electric conductivity known as semi-conductivity. These ceramic-based semiconductors are critical to the microelectronics industry.<sup>93</sup>

Recent advancements in understanding the science behind the atomic configurations of ceramics, and how these configurations give them their unique properties, has led to new understanding of the kinds of materials that can be made from ceramics.<sup>94</sup> Modern day ceramics can be made more fracture resistant, and have found wider uses than the "traditional ceramics" used for bricks, china, porcelain, and glass. Today, ceramics are used in varied applications, from cookware to computers. The relatively recent breakthrough is at least partly attributable to the ability to understand ceramics at the atomic level. This understanding spurred new ceramics to take advantage of the properties induced by changes or deformities in their atomic structures. Some deformities are therefore useful, but unintended deformities are not likely to be so. Ceramics in environments where phenomena can cause changes in the properties or locations of individual atoms will be subject to AEC. Unlike chemical oxidation-reduction reactions, which require specific types of atoms,





**The unique atomic properties of ceramics explain why the structures of ceramics are more complex than those of metals.**

92. *Ibid.*

93. E. Catherine Housecroft and G. Alan Sharpe, *Inorganic Chemistry* (Pearson Education Limited, 2001).

94. April Gocha, "New Atomic-scale Observations Could Lead to Engineering of Ductile yet Strong Ceramics," *The American Ceramic Society*, 12 April, 2015, <http://ceramics.org/ceramic-tech-today/new-atomic-scale-observations-could-lead-to-engineering-of-ductile-yet-strong-ceramics>.

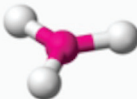
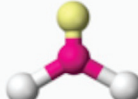
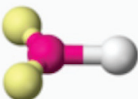
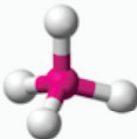
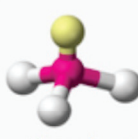
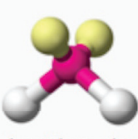
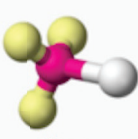
ions and molecules in order to occur, high-energy collisions from gamma radiation or high-speed neutrons that cause AEC do not discriminate when it comes to what types of materials can be degraded.

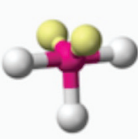
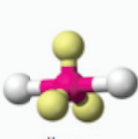
Steric No.	Basic Geometry 0 lone pair	1 lone pair	2 lone pairs	3 lone pairs	4 lone pairs
1	 linear				
2	 linear	 linear			
3	 trigonal planar	 bent / angular	 linear		
4	 tetrahedral	 trigonal pyramid	 bent / angular	 linear	
5	 trigonal bipyramid	 sawhorse / seesaw	 t-shape	 linear	

Bond geometries associated with valence-shell electron-pair repulsion theory (VSEPR). (CC BY-SA 3.0)

## Structures

Basic ceramic structures come in two types, depending on the bond structures: those that are strictly ionic, and those that are a mix between ionic and covalent.<sup>95</sup> The difference in the bonding types determines the atomic structures of different ceramics.

Ionic bonds are the strongest chemical bonds because they occur between two atoms separated by at least one complete charge.<sup>96</sup> All other bonds occur because of charge separation, but only ionic bonds occur because of the attractive force stimulated by total charge separation. For ceramics, the cations (positive ions) are metals and the anions (negative ions) are non-metals. The crystal structures of ceramics are a function of the magnitude of the electrical charge on each ion and their relative ionic radii. In order for a ceramic solid to form, the charges within the unit cell of the crystal lattice must bal-

95. "Scientific Principles," *University of Illinois*, Accessed 14 Sept 2015, <http://matse1.matse.illinois.edu/ceramics/prin.html>.

96. E. Catherine Housecroft and G. Alan Sharpe, *Inorganic Chemistry* (Pearson Education Limited, 2001).

ance, so the net charge on that cell is neutral. This requirement has a large impact on the nature of the atomic orientations observed within the unit cell. Because cation nuclei have a greater pull on their remaining valence electrons, their atomic radii tend to be smaller than those of the corresponding anions. This geometry creates a fundamental difference between ceramic and metal crystal lattice structures. In metals, the atomic radii are similar; in ceramics the unit cell consists of different sized ions, and thus different structures are possible. The most stable ceramic structures are those where all cations and anions are “in contact” within one another; “in contact” means there is overlap between bonding orbitals (see the figure below).<sup>97</sup>

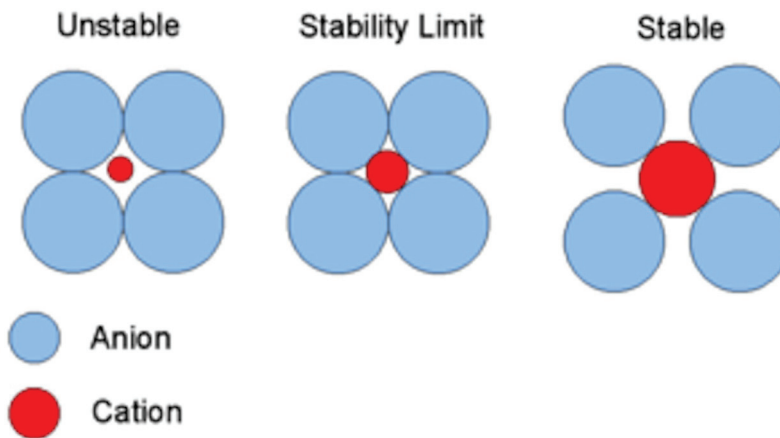

Critical Radius Ratio/Matthew Rollings

The coordination numbers of ionic compounds are also different than those of metals. Coordination number is typically greater for ions with larger ionic radii, and less with smaller radii. The coordination number has the same effect, though: the larger the coordination number, the more tightly packed the unit cell is.<sup>98</sup> Because ionic crystal lattice structures must balance, there are several variations that commonly exist amongst ceramics.<sup>99</sup> The lattice designations are typically denoted  $A_mX_p$ , where A is the cation, X is the anion and the subscripts m and p denote the ratio of each in the unit cell. For a 1:1 ratio, m and p are 1 and these types of lattice structures are denoted AX-type crystal structures.

Lattice structures for ionic compounds are typically determined by the anion packing style. For AX structures, the anions typically pack in face-centered cubic or simple cubic arrangements. The compounds sodium chloride (NaCl), cesium chloride (CsCl), and zinc sulfide (ZnS) have coordination numbers of 6, 8, and 4, respectively. Even though the ratios in the unit cell are equal, the different coordination numbers arise from the different charge magnitudes and relative sizes of the ions. Other ceramic ionic compounds have

97. D. William, Callister, G. David Rethwisch, *Fundamentals of Materials Science and Engineering: An Integrated Approach* (John Wiley & Sons, Inc, 2012).

98. *Ibid.*

99. D. William, Callister, G. David Rethwisch, *Fundamentals of Materials Science and Engineering: An Integrated Approach* (John Wiley & Sons, Inc, 2012).

ratios different from 1:1, such as  $\text{CaF}_2$ , and these lead to different properties. One of the more interesting ionic structures is composed of two different cations, typically referred to as  $\text{A}_m\text{B}_n\text{X}_p$ .  $\text{BaTiO}_3$  is a ceramic ionic compound in this category, and this ceramic takes on what is known as a *perovskite* crystal structure. This atomic structure gives rise to some unique electromagnetic properties, such as colossal magnetoresistance and superconductivity.<sup>100</sup>

Ceramics are capable of forming close packed structures. These ceramic structures consist of closely packed planes of ions. The packing of the planes leads to interstitial sites that can take on particular geometries such as tetrahedral and octahedral. The factors that influence these geometries are the close-packed anion layers and the manner in which cations occupy the interstitial sites. Whether a particular ceramic lattice structure tends to surround the cations with four or six anions depends on which orientation provides the structure with the most thermodynamically stable configuration. For example, in the crystal structure of sodium chloride (i.e., table salt) the most stable configuration is to occupy sodium atoms in an octahedral configuration, such that each sodium cation is "touching" six other chloride ions.

While many ceramics take on these stacking behaviors, some do not. The perovskite crystal structure, for example, has unique properties associated with it. There is a spinel structure associated with the  $\text{A}_m\text{B}_n\text{X}_p$  lattice structure (see "Spinel structure" figure, page 117).  $\text{MgAl}_2\text{O}_4$  for example (a ceramic used in structural, chemical, optical and electrical industries)<sup>101</sup> has the  $\text{O}^{2-}$  anions packed in a face-centered cubic arrangement.<sup>102</sup> This arrangement creates both tetrahedral and octahedral interstitial sites. For this particular material, the  $\text{Mg}^{2+}$  occupy the tetrahedral sites and the  $\text{Al}^{3+}$  occupy the octahedral sites. Many magnetic ceramics take on variations of such spinel lattice structures, and their magnetic properties are determined by the nature of the cations that occupy the tetrahedral and octahedral sites.<sup>103</sup>

100. "Ferroelectric Properties of a  $\text{BaTiO}_3$ ," *Materials Design, Inc.*, 2009, Accessed 29 Sept 2015, [www.materialsdesign.com/system/files/appnotes/BaTiO3\\_1.pdf](http://www.materialsdesign.com/system/files/appnotes/BaTiO3_1.pdf).

101. Lim Rooi Ping, Abdul-Majeed Azad, and Teng Wan Dung, "Magnesium aluminate ( $\text{MgAl}_2\text{O}_4$ ) spinel produced via self-heat-sustained (SHS) technique," *Material Research Bulletin* 36 (2001): 1417-1430.

102. A.R. Molla, C.R. Kesavulu, R.P.S. Chakradhar, A. Tarafder, S.K. Mohanty, J.L. Rao, B. Karmakara, and S.K. Biswas, "Microstructure, mechanical, thermal, EPR, and optical properties of  $\text{MgAl}_2\text{O}_4$ : $\text{Cr}^{3+}$  spinel glass-ceramic nanocomposites," *Journal of Alloys and Compounds* 583 (15 Jan 2014): 498-509. 509.

103. Raul Valenzuela, *Magnetic Ceramics (Chemistry of Solid State Materials)*, (Cambridge University Press, 2005).

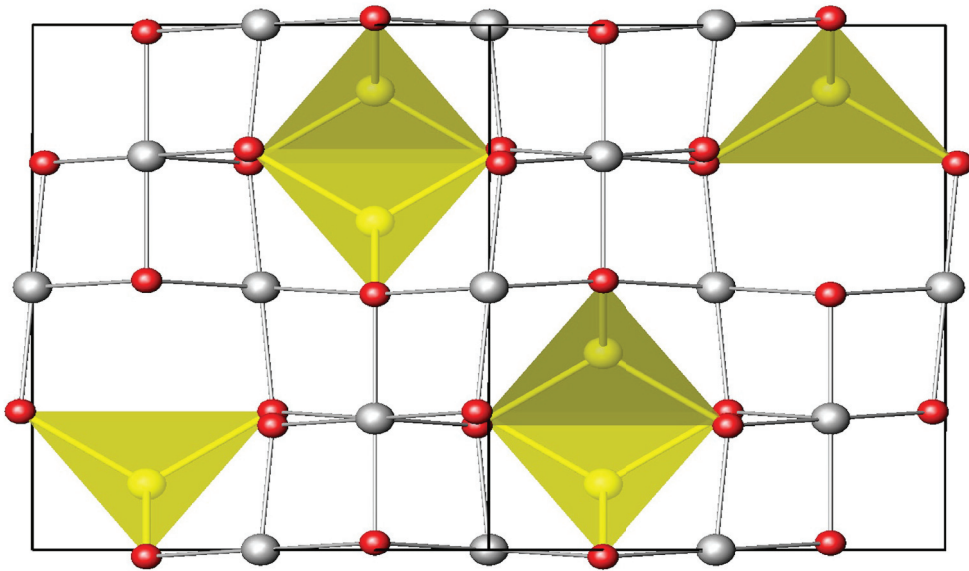

Spinel structure/Peridotite

Silicates are another important category of ceramics.<sup>104</sup> Silicates consist of silicon and oxygen. Given that these are two of the most abundant elements in the earth's crust, silicates tend to be major components of soils, rocks, clays and sand. Silicate ceramics can have either crystalline or amorphous structures (see the two figures at the top of page 118). For structures that are amorphous, AEC is less relevant because the major impact of atomic effects is the introduction of disorder into ordered atomic structures. Therefore, our discussion of silicate ceramics will focus on the structure of the more ordered varieties.

The various silicate geometries arise from the covalent character of the Si-O bonds. Silicon has 4 valence occupancies and a tetrahedral electronic geometry.<sup>105</sup> This means that each silicon atom in a silicate exists in an oxidation state of +4, and each oxygen atom exists in an oxidation state of -2. The  $\text{SiO}_4^{-2}$  tetrahedron makes up the basic structure in which silicates exist. The different 1, 2 and 3-dimensional structures it forms determine the type of silicate and its properties. The Si-O bonds within silicates are covalent, and the different structures that silicates manifest are consequences of secondary bonding schemes such as van der Waals forces.

Silica,  $\text{SiO}_2$ , is the simplest silicate. It is comprised of an arrangement of  $\text{SiO}_4^{-2}$  tetrahedrons, but the crystal structure that forms has an overall ratio of 2 oxygen atoms for every silicon

104. D. William, Callister, G. David Rethwisch, *Fundamentals of Materials Science and Engineering: An Integrated Approach* (John Wiley & Sons, Inc, 2012).

105. E. Catherine Housecroft and G. Alan Sharpe, *Inorganic Chemistry* (Pearson Education Limited, 2001).

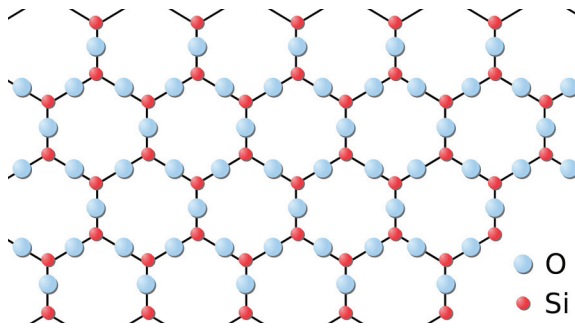

Chemical structure of Quartz/Wimmel

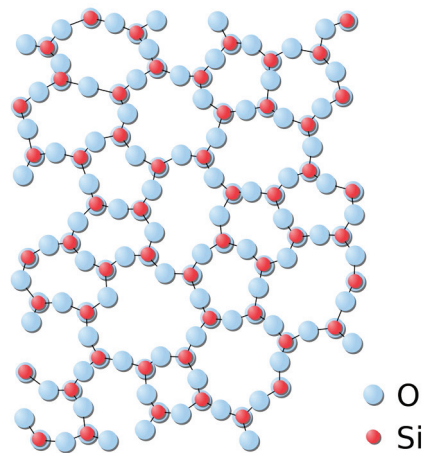
The amorphous structure of glassy Silica (SiO<sub>2</sub>) in two-dimensions/Wimmel

atom. Quartz is a well-known silicate important for several applications, such as oscillators for frequency and timing. In addition, despite the fact that silicates have relatively open atomic structures, and are less densely packed than metals and other ceramics, they can withstand high temperatures. This makes silicates useful in the construction of space ship hulls and engine components.<sup>106</sup>

Silicates can form complex atomic arrangements due to the fact that one, two, or three of the O atoms in the SiO<sub>4</sub><sup>-2</sup> tetrahedrons can be part of another tetrahedron. Silicate structures can also incorporate other ions such as Ca<sup>2+</sup>, Mg<sup>2+</sup>, and Al<sup>3+</sup> in order to achieve crystal neutrality, and these ions further strengthen the structure by bonding ionically to the tetrahedra. For example, akermanite (Ca<sub>2</sub>MgSi<sub>2</sub>O<sub>7</sub>) is a silicate mineral that has potential biomaterial applications (one application is as a biodegradable coating used in biomedicine); it has a complex structure dependent on the Ca<sup>2+</sup> and Mg<sup>2+</sup> ions.<sup>107</sup>

Layered silicates have meta-atomic structures that occur when three oxygen ions in the silicate tetrahedra are shared. For example, kaolinite clay is a layered silicate with the formula Al<sub>2</sub>(Si<sub>2</sub>O<sub>5</sub>)(OH)<sub>4</sub>. The U.S. Naval Medical Research Institute used a kaolinite-derived aluminosilicate nanoparticle to infuse gauze and develop QuickClot Combat Gauze that facilitates the rapid clotting of wounds.<sup>108</sup> Kaolinite's silica layer is made neutral by a layer of Al<sub>2</sub>(OH)<sub>4</sub><sup>2+</sup>. This two-layered sheet is held together through strong ionic-covalent bonds, and adjacent sheets are held together through secondary bonds (e.g., van der Waals).

Although the structures of various ceramics are more complex and less ordered than the structures of metals, ceramic structures arise through strong bonds that are both ionic

106. Ulrich Schubert, ed., *Silicon Chemistry* (Austria: Springer-Verlag Wien, 1999).

107. "Åkermanite," *Wikipedia*, Modified 3 March 2013, Accessed 12 Sept 2015, <https://en.wikipedia.org/wiki/Åkermanite>.

108. BT Gegel, et al. "An evidence-based review of the use of a combat gauze (QuickClot) for hemorrhage control," *American Association of Nurse Anesthetists Journal* 81, No. 6 (2013): 453-458.

and covalent in nature. Defects in the structures of ceramics (see figure below) therefore tend to result in atomic configurations that promote diffusion, which ultimately results in lattice deformations and degradation of the ceramic's material properties. Because ceramics are typically comprised of ionic substances, they need to retain their electro-neutrality to ensure their structures. As with metals, the atomic structures of ceramics can experience both vacancies and interstitials. A major difference between metals and ceramics is that in ceramics, the atomic point defects can occur with two different types of ions rather than just a single type metal atom. The nature of a vacancy or interstitial defect will differ, depending on whether a cation or anion is at the center of the defect.

### Crystal Lattice Point Defects

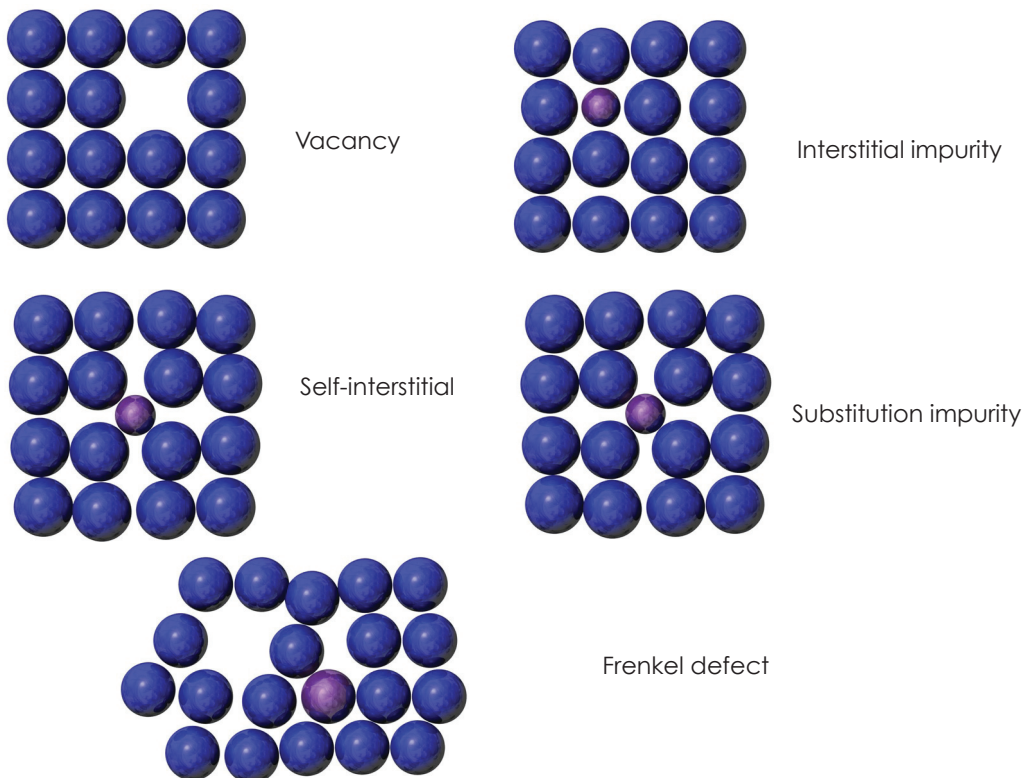

Atomic effects can displace atoms from their lattice structures, and can thereby lead to defects in the atomic structure of ceramics. Frenkel defects occur in ceramics when a cation migrates from its normal lattice position to an interstitial site within the lattice, causing deformities.<sup>109</sup> This migration can also cause a change in the lattice polarity, potentially creating a charge gradient that facilitates further ion migration within the ceramic. In metals, such events may lead to problems such as tin whiskers. In ceramics, these events can also result in adverse effects such as fracturing. In AX type ceramics, for example, Schottky defects occur when both a cation and anion vacate their interior lattice positions. In instances where a defect causes a change in the charge stoichiometry, substitutions can be made as long as the replacement ion is of similar relative size and charge.<sup>110</sup> Still, such replacements will distort lattice structures. Non-stoichiometric degradation events can occur through other mechanisms, such as when one of the ions within the lattice structure is capable of taking on multiple oxidation states. Iron oxide is such a material, and if an iron ion ( $\text{Fe}^{2+}$ ) undergoes a further oxidation event, a charge of +1 will arise within the lattice. The most likely correction of this imbalance is creation of an  $\text{Fe}^{2+}$  vacancy to retain the thermodynamically stable electroneutral structure. These moves result in changes to the ceramic's properties. The likelihood of a Frenkel or Schottky defect is a function of the energy required to form the defect, the number of lattice sites, and temperature.<sup>111</sup>

Impurities in ceramics lead to different material properties. In a sense, impurities can be a two-way street for defects in ceramic lattice structures. They can be the root cause of lattice defects, or they can be the solution to lattice defects (see figure page 120). The introduction of impurities tends to be facilitated by the need to maintain electrical neutrality in the ceramic lattice structure. When vacancies arise in ceramics they create opportunities for diffusion. Diffusion is the natural tendency of atoms, ions, and molecules to move to areas where their concentrations are lower. If a material depends

**Ceramic structures arise through strong bonds that are both ionic and covalent.**

on its atomic structure, diffusion represents a mechanism that requires an initiating event, such as a vacancy. The displacement of an atom from a lattice will create not only a temporal concentration gradient, but also a temporal charge gradient. There are many natural mechanisms that can create such displacements and trigger the onset of diffusion-induced degradation. Atomic effects can also be the culprit. These diffusion defects are not always immediately apparent, and thus the root cause of a deleterious effect may be overlooked. Damage to atomic lattice

structures leads to the eventual breakdown of microstructures, which changes macro material properties. Understanding the role that atomic effects play in creating vacancies will become more important as ceramic structures are increasingly applied in micro- and nanomaterial designs.

109. D. William, Callister, G. David Rethwisch, *Fundamentals of Materials Science and Engineering: An Integrated Approach* (John Wiley & Sons, Inc, 2012).

110. *Ibid.*

111. *Ibid.*



## Ceramics Properties

Ceramics are used for different purposes in various systems, components and technologies. Ceramics are typically more brittle than metals, but are also often stronger, harder, and more heat resistant. They are typically poor conductors because their atomic structures depend on bonding schemes that do not favor delocalization. Ceramics are therefore good insulators, and have been used as such for many years. Ceramics can take on magnetic properties (e.g.,  $\text{Fe}_3\text{O}_4$ ), and those properties depend on specific lattice configurations.<sup>112</sup>

Traditional ceramics are typically made from processed silica and clay. These create glass and cement-like ceramics. Newer ceramics are designed differently and manifest a wider range of properties, such as more ductility. Although not strictly ceramics, the properties of silicon and carbon are normally discussed in the context of ceramics. These two substances play important roles in microelectronics and nanotechnologies.

Ceramics such as those used for piping and high-temperature conditions are likely less sensitive to a few individual AEC events than other types. Due to the nature of their bonding schemes, their lattice structures are stronger, and a single displacement defect on the lattice will have less of an immediate impact on their macroproperties. Other properties though, such as their electrical and magnetic properties, can be affected by AEC, especially in materials used for microelectronics and nanotechnologies. AEC certainly play a role in initiating events that in turn can lead to the degradation of ceramic microstructures, and the concomitant loss of macroscale properties, through classical corrosion mechanisms. As with metals, AEC can couple with classical corrosion to degrade ceramics.

## Traditional Ceramics

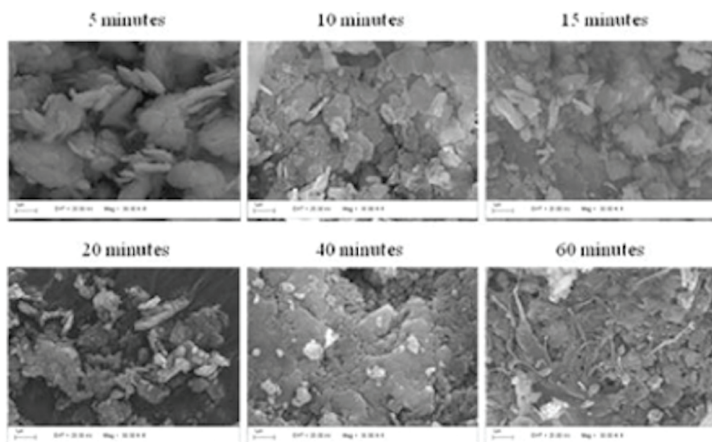

Examples of traditional ceramics/ SciELO.org

112. JM Galloway, "Biotemplating arrays of nanomagnets using the biomineralisation protein Mms6," PhD thesis, University of Leeds (2012).

Traditional ceramics (see figure 121) make good insulators (both heat and electricity) and thus are frequently used to insulate other materials. Although the properties of common insulators depend on their crystal lattice configurations, AEC is seldom a “direct” problem because it has to affect the connectivity of hundreds of thousands of atoms to be noticeable. These are the cases where AEC may act to accelerate other forms of corrosion. Traditional ceramics are strong, hard, heat-resistant and brittle. They are utilized by DoD and society for structural purposes.

The important properties of traditional ceramics used in cement, piping, and other structural applications are not likely to be significantly degraded due to AEC at the macroscale. This is not to say that AEC does not matter at the macroscale: as mentioned before, AEC caused by ionization or displacement can lead to atomic point defects that create lattice defects, which can ultimately result in microfracturing. In structural ceramic applications, microfracturing can lead to structural failure.

### *Advanced Ceramics*

Advancements in material science have enabled scientists and engineers to understand the relationships between the atomic makeups of ceramic materials and how they manifest into the material properties that make ceramics useful in modern society. With the invention of new manufacturing and processing technologies, ceramics have found new applications that take advantage of the underlying phenomena that give them their structures and properties.

MEMS are small, “smart” technological systems that integrate micron sized mechanical systems with electrical elements mounted on a silicon substrate (see figure 123).<sup>113</sup> These systems incorporate precisely engineered microstructures that act as sensors and actuators. The sensor materials have specific atoms, ions, or molecules in specific crystal lattice structures that collectively demonstrate predictable behaviors in response to mechanical, thermal, chemical, optical and/or magnetic stimuli. For example, an increase in a microsensor’s temperature might cause a change in the packing within the lattice unit cell; that change is detected by an adjacent microsystem connected through a pathway that allows for allosteric communication. Thus, changes in the material properties of the microsensors can be processed by microelectronic components of the MEMS, which in turn generate another atomic change to signal to activate a microactuator. In this sense, MEMS can form an environmental signal/response system, where the atomic substructures of their microsystems respond to various stimuli, these stimuli are processed through materials capable of mathematical operations and information processing (e.g., transistors) and then a desired response from the MEMS actuator is produced. These responses can perform functions such as moving, filtering, pumping, regulating, or positioning. Thus, MEMS can be micron-sized versions of machines such as gears or motors, or other structures such as membranes.

---

113. “Microelectromechanical systems,” *Wikipedia*, Modified 28 Sept 2015, Accessed 12 Sept 2015, [https://en.wikipedia.org/wiki/Microelectromechanical\\_systems](https://en.wikipedia.org/wiki/Microelectromechanical_systems).

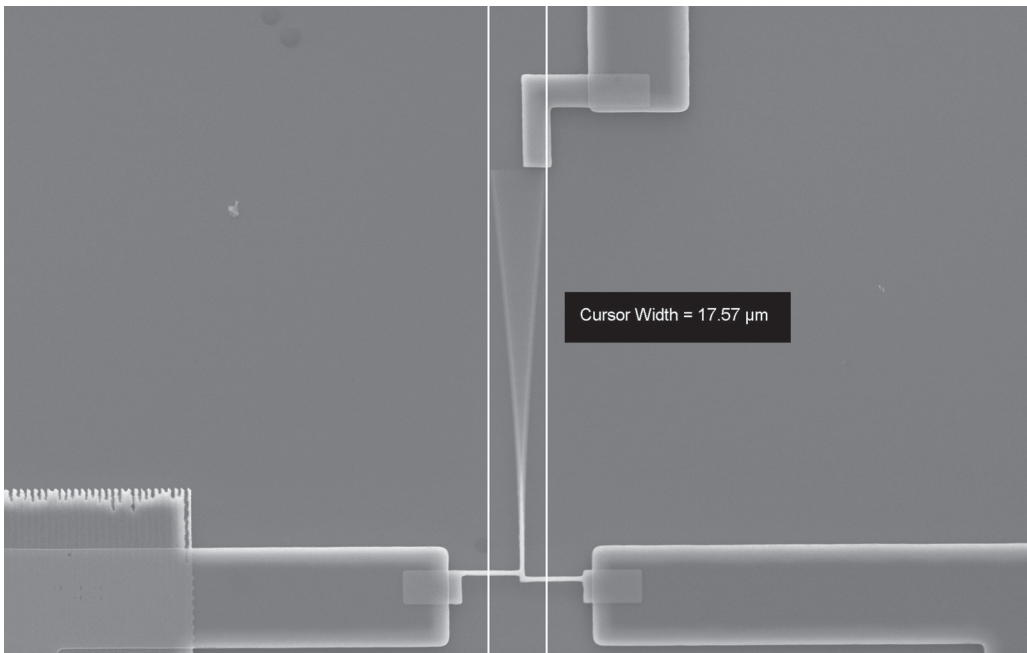

MEMS microcantilever resonating in an SEM./Pcfllet01

MEMS are produced with the same processes used to create silicon-based integrated circuits. These include photolithographic, ion implantation, etching, and deposition technologies, as well as other micromachining techniques. There are limitations with relying heavily on silicon for MEMS, due to silicon's low fracture toughness, its low softening temperature, and its reactivity in the presence of water and oxygen. For these reasons, materials such as silicon carbonitrides (silicon carbide-silicon nitride alloys) are being considered for use in MEMS.<sup>114</sup> There are already uses for MEMS today, and likely to be more applications of MEMS in the future. For example, MEMS may be used as chemical detectors for hazardous materials,<sup>115</sup> microsystems for DNA amplification,<sup>116</sup> and data storage.<sup>117</sup> The working parts of MEMS are microstructures that depend on the integrity of the underlying atomic structures to work. Just as classical corrosion can lead to degradation of modern day macromechanical equipment, AEC can be a key player in the degradation of MEMS.

Nanoelectromechanical systems (NEMS), which are the nano equivalent of MEMS, are the next scale step in this technological evolution: from macro, to micro, to nano.<sup>118</sup> Cur-

114. Victor M. Bright, Rishi Raj, Martin L. unn, and John W. Daily, *Injectable Ceramic Microcast Silicon Carbon Nitride (SiCN), Micro Electro Mechanical Systems (MEMS) for Extreme Temperature Environments with Extension: Micro Packages for Nano Devices* (New York, NY: January 2004).

115. Sarah S. Bedair and Gark K. Fedder, "CMOS MEMS Oscillator for Gas Chemical Detection," *Department of Electrical and Computer Engineering, Carnegie Mellon University* (Pittsburgh, PA), 2004.

116. Zhang C, Xu J, Ma W, and Zheng W, "PCR microfluidic devices for DNA amplification," *Biotechnological Advances* 3 (2 Dec 2005): 243-284.

117. Bo Hong, Feng Wang, Scott A. Brandt, Darrell D.E. Long, and Thomas J.E. Schwarz, "Using MEMS-Based Storage in Computer Systems-MEMS Storage Architectures," *ACM Transactions of Storage* 2, No.1 (Feb 2006): 1-21.

118. M.L. Roukes, "Nanoelectromechanical Systems," *Condensed Matter Physics* (California Institute of Technology, CA: 2000), <http://arxiv.org/pdf/cond-mat/0008187.pdf>.

rently, NEMS materials rely heavily on the science of various allotropes of carbon, such as diamond and graphene. These allotropes contain the necessary mechanical properties needed for NEMS to function, and the metalloid characteristics of carbon allow for the desired metallic and semiconductor electric behavior required in NEMS. NEMS will be highly susceptible to AEC as their nanometer scaled structures will be sensitive to a few atomic changes. At this scale, their material properties depend on the correct configuration of atoms, and the disruption of a few atoms may cause NEMS to fail.

Piezoelectric ceramics have been used for some time for both commercial and military applications, and their use continues in modern day technologies due to their electromechanical behavior. The piezoelectric property (see figure page 125) arises in ceramics with crystal lattice structures that contain a low-degree of symmetry.<sup>119</sup> The word piezoelectricity basically translates to "pressure electricity." When a mechanical stress is applied to the crystal structure of a piezoelectric ceramic, a voltage is induced between the parts of the crystal lattice that are stressed. Conversely, if a voltage is placed across a piezoelectric ceramic crystal lattice, a mechanical stress will result. Ceramics that demonstrate this property include  $\text{PbZrO}_3$ ,  $\text{NH}_4\text{H}_2\text{PO}_4$ ,  $\text{BaTiO}_3$  and quartz ( $\text{SiO}_2$ ). Piezoelectrics first made a "practical" name for themselves in submarine sonars.<sup>120</sup> The British navy developed a sonar that used two piezoelectric materials, one for emitting a signal and one for receiving a return signal. The piezoelectric emitter would have a voltage applied to it and subsequently emit a high-frequency<sup>121</sup> mechanical vibration that would travel through seawater. When the vibration wave hit an underwater object, the return signal would strike the piezoelectric receiver, which would interpret the vibrational energy signature into an electrical signal that could be analyzed to reveal the approximate location of that object. Aside from sonar, piezoelectric ceramics have found their way into many different technologies and systems. For example, they can be found in automotive wheel balancers,<sup>122</sup> air bag sensors,<sup>123</sup> as microactuators in hard disk and notebook computer transformers,<sup>124</sup> smoke detectors,<sup>125</sup> and ultra-sound equipment for medical diagnosis.<sup>126</sup>

119. E. Catherine Housecroft and G. Alan Sharpe, *Inorganic Chemistry* (Pearson Education Limited, 2001).

120. Shaul Katzir, "Who knew piezoelectricity? Rutherford and Langevin on submarine detection and the invention of sonar," *Notes & Records of the Royal Society* 66, No. 2 (June 2012): 141-157.

121. Boyle BIR 23 November 1916: 'Production and reception of high-frequency sound waves by the method of the Brown grid magnetophone' (BIR 14243/16), UKNA ADM 293/5.

122. "Piezo-ceramic sensors and sensor applications," *Ceramtec*, Accessed 30 Sept 2015, <https://www.ceramtec.com/applications/piezo-applications/sensor-technology/>.

123. "Piezoelectric Ceramic Devices Automobile Innovation," *Morgan Advanced Materials*, 13 July 2010, Accessed 29 Sept 2015, <http://www.morgantechnicalceramics.com/downloads/technical-articles/piezoelectric-ceramic-drives-automobile-innovation>.

124. Yang Jing, Luo Jianbin, Wenyan Yang, and Guoxian Ju, "Fabrication of piezoelectric ceramic micro-actuator and its reliability for hard disk drives," *IEEE Trans Ultrason Ferroelectr Freq Control* 5, no.11 (2004): 1470-1476.

125. "Smoke Detector," *Wikipedia*, Modified 22 Sep 2015, Accessed 18 Sept 2015, [https://en.wikipedia.org/wiki/Smoke\\_detector](https://en.wikipedia.org/wiki/Smoke_detector).

126. "Generation of an Ultrasound Wave," *USRA*, 2008, Accessed 29 Sept 2015, <http://www.usra.ca/generationof-wave.php>.

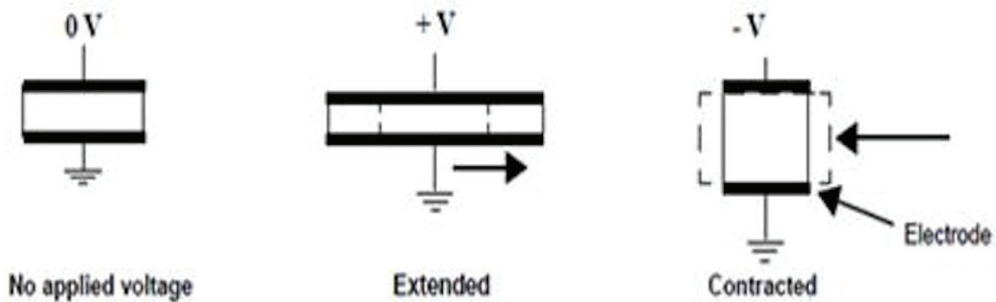

The effect of applied voltage on piezoelectric materials/Creepin475

Piezoelectric ceramic materials provide the ability to transduce mechanical energy into electrical energy. The trend, as in other areas, is using smaller structures in future applications. The piezoelectric property depends on the complex nature of the crystal lattice in piezoelectric ceramics. As a result, only a very small number of atomic changes to the crystal lattice have to occur before the material's properties begin to degrade. As future applications trend toward smaller structures, the displacement of a single atom due to interaction with a high-energy gamma ray or fast neutron may be all that is needed to degrade the piezoelectric property of that material to a level that no longer meets the material design requirements.

Silica is finding a new use as an optical fiber in the communications sector.<sup>127</sup> "Ultrapure silica" is virtually free from any impurity or defect that may cause absorption, scatter, or attenuation of light. Processors are being developed that use silica fibers that are approximately the diameter of the human hair to transmit information with improved information density, reduced error rate and increased transmission distance. Given the importance of communications within the DoD and the reliance on technologies that increase information density, fiberoptics will seek to create smaller silica cores that can be packaged to transmit more information faster. As with any submicron structure, the impact of AEC will be more destructive if its mechanisms and the resultant effects on these structures are not well understood.

Although not "true" ceramics, carbon allotropes and silicon currently play (and will play in the foreseeable future) a large role in the capabilities of modern day microelectronics. These elements are a mix between metals and non-metals (i.e., metalloids) and thus tend to experience properties of both within a single material. One such property displayed in both graphene and silicon is the property of semi-conducting. Silicon has become ubiquitous in microelectronics. The silicon transistor played a major role in bringing about

127. "Hard-clad silica optical fiber," *Wikipedia*, Modified 20 March 2013, Accessed 28 Sept 2015, [https://en.wikipedia.org/wiki/Hard-clad\\_silica\\_optical\\_fiber](https://en.wikipedia.org/wiki/Hard-clad_silica_optical_fiber).

the digital revolution.<sup>128</sup> Transistors are nanometer crystals of silicon doped with elements such as phosphorus or boron to create polarized regions within the material that provide the desired functionality. A typical MOSFET transistor is shown in the figure below.

Silicon crystals are comprised of a large lattice of tetrahedral silicon atoms, and these atoms are covalently bonded.<sup>129</sup> The electrical properties of a pure silicon crystal can be altered dramatically by the introduction of a few dopant atoms. For example, the addition of phosphorus brings an added electron that can be delocalized in the 3 d-orbitals of silicon and phosphorus.<sup>130</sup> The network of orbitals in which electrons can be delocalized within the silicon lattice is typically referred to as the “conduction band.” The energy difference between the conduction band and the valence orbital an electron normally resides in is known as the energy gap. By using different semi-conducting materials or precise doping of silicon substrates, the energy gap can be modified to meet specific needs. For example, the quantum tunneling diode works by creating an energy band gap that promotes the phenomenon of quantum tunneling. This is accomplished by precisely doping the silicon lattice at the p-n junction (an area 10 nm or less wide) to create a conduction band gap in which the n-side conduction band states are essentially equal to the p-side valence hole states.<sup>131</sup> These properties only exist within these materials at the atomic scale. Many argue that no other material is more important to technological superiority in the digital age than the materials used to transmit, pro-

128. “Transistor,” *Wikipedia*, Modified 26 September 2015, Accessed 28 Sept 2015, <https://en.wikipedia.org/wiki/Transistor>.

129. “Silicon,” *Wikipedia*, Modified 29 Sept 2015, Accessed 1 Oct 2015, <https://en.wikipedia.org/wiki/Silicon>.

130. Pr. Ali Javey, “Integrated Circuit Devices,” *Semiconductor Fundamentals Lecture 1* (University of California, Berkeley, 28 Aug 2007), [http://www-inst.eecs.berkeley.edu/~ee130/fa07/lectures/Semiconductor\\_fundamentals\\_lec1.pdf](http://www-inst.eecs.berkeley.edu/~ee130/fa07/lectures/Semiconductor_fundamentals_lec1.pdf).

131. Thomas Engel and Philip Ried, *Physical Chemistry* (Pearson Education, Inc. 2006).

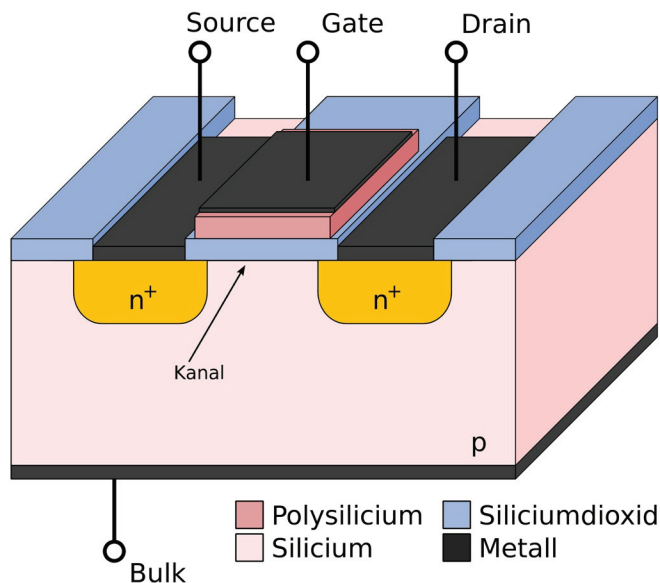

Basic structure of an n-channel MOSFETs in cross-section (planar)/Hennig

cess, and analyze information signals. And as these materials become smaller in scale in micro- and nanoelectronic technologies, they also become more susceptible to the impacts of AEC.

One of the mechanisms used to create n-type silicon is called neutron transmutation doping; this process literally uses atomic effects to create a desired property. The absorption of a high-speed neutron by  $^{30}\text{Si}$  converts the silicon to  $^{31}\text{P}$  through the nuclear reaction:

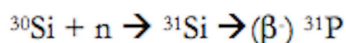

One way in which this can be accomplished is by placing a pure silicon crystal near a nuclear reactor to absorb neutrons.<sup>132</sup> Although not as widely used as diffusion or ion implantation, neutron transmutation doping has the added characteristic of creating uniform dopant distribution. The neutron transmutation doping procedure takes advantage of an environment that produces the phenomena (e.g., neutrons) capable of producing atomic effects. This leads to changes in the atoms within the lattice structures of a material, and fundamentally alters the materials properties in a way that is clearly distinguishable (i.e., changing from insulator to conductor). Both DoD and the world in general are becoming more reliant on devices like the transistor, and new materials are being designed that utilize different electrical, magnetic, and/ quantum properties to create new capabilities.

The use of doping to create new material properties is a form of AEC that is beneficial, but other AEC mechanisms are not. Developing science makes it clear that we need to understand the phenomena that degrade the lattice structures of materials as well as those that lead to desirable design features. Otherwise, we may realize, after the fact, the impact and costs of AEC are significant. This recognition occurred in the classical corrosion arena in 2002: a report by NACE<sup>133</sup> informed DoD of the true cost of classical corrosion, which was considerably higher than expected.

Carbon nanotubes are another pseudo-ceramic nanostructure that offers the potential to revolutionize the nanotechnology world in ways that may parallel what silicon has done for microelectronics.<sup>134</sup> Carbon nanotubes obtain their unique mechanical and electrical properties due to the very precise lattice orientations that form upon their creation. Carbon nanotubes are essentially a single plane of graphite (i.e., graphene) rolled onto itself and capped with a  $\text{C}_{60}$  fullerene. This gives the nanotubes a roughly 100-nm di-

132. "Neutron Transmutation Doping of Silicon at Research Reactors," *International Atomic Energy Agency* (Vienna, Austria: 2012), [http://www-pub.iaea.org/MTCD/Publications/PDF/TE\\_1681\\_web.pdf](http://www-pub.iaea.org/MTCD/Publications/PDF/TE_1681_web.pdf).

133. Gerhardus H. Koch, Michiel P.H. Brongers, and Neil G. Thompson, "Corrosion Costs and Preventive Strategies in the United States," *NACE International*, 2002, <http://www.nace.org/uploadedFiles/Publications/ccsupp.pdf>.

134. "Carbon Nanotube," *Wikipedia*, Modified 30 Sept 2015, Accessed 1 Oct 2015, [https://en.wikipedia.org/wiki/Carbon\\_nanotube](https://en.wikipedia.org/wiki/Carbon_nanotube).

ameter. Nanotubes are covalently bonded, making them an extremely large molecule: essentially a cross between a ceramic, a metal, and polymer. This phenomenon allows the nanotubes to be extremely strong (it is the strongest known material) and stiff while also being fairly ductile.

By changing the connectivity of the lattice that holds the nanotube together, different properties result, such as the ability to change from a conducting material to semiconducting material (see Nanotubes figure below). The orientation of the hexagonal subunits of the graphene motif relative to the tube axis determines the electrical conductance properties of the material. The impact these types of materials are going to have in the near future with regards to materials and technologies could be huge. Given their size and reliance on the integrity of their lattice structures for their unique properties, it is important to comprehend the impacts AEC could have on such materials.

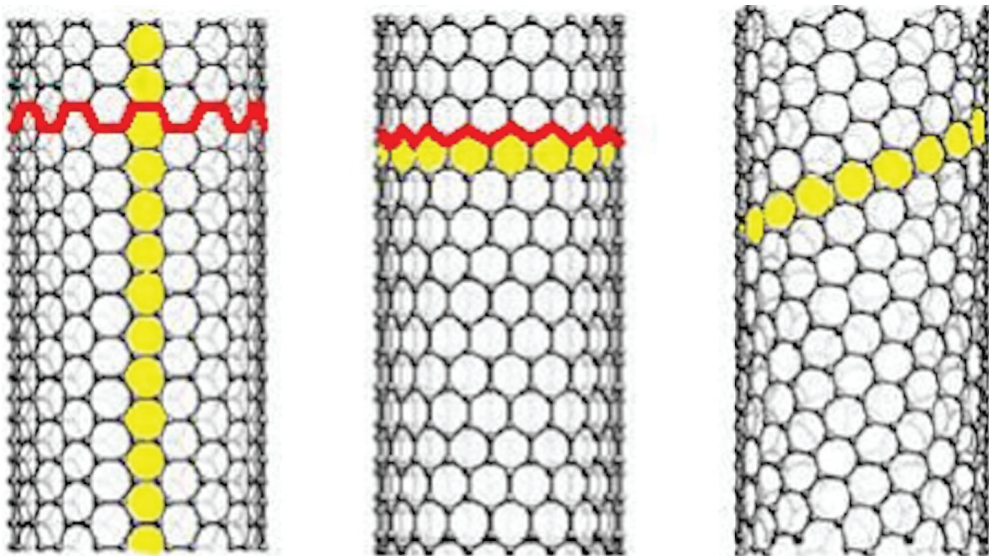

Nanotubes: armchair or zigzag/W2raphael



## POLYMERS

### Basics of Polymers

Polymers are another class of materials used to engineer systems with desirable properties and behaviors.<sup>135</sup> The figure below shows the different classifications of polymers. Compared to metals and ceramics, polymers differ in their material properties due to the nature of the molecular structures that hold them together. Polymers may be natural or synthetic. All polymers are defined by the fact their connectivity consists of a series of linked subunits, normally termed “repeating units,” bound by covalent bonds. Most polymers are hydrocarbon based, meaning that the repeating unit of the polymer is made up of covalently linked carbon atoms that are bound to at least one hydrogen atom.

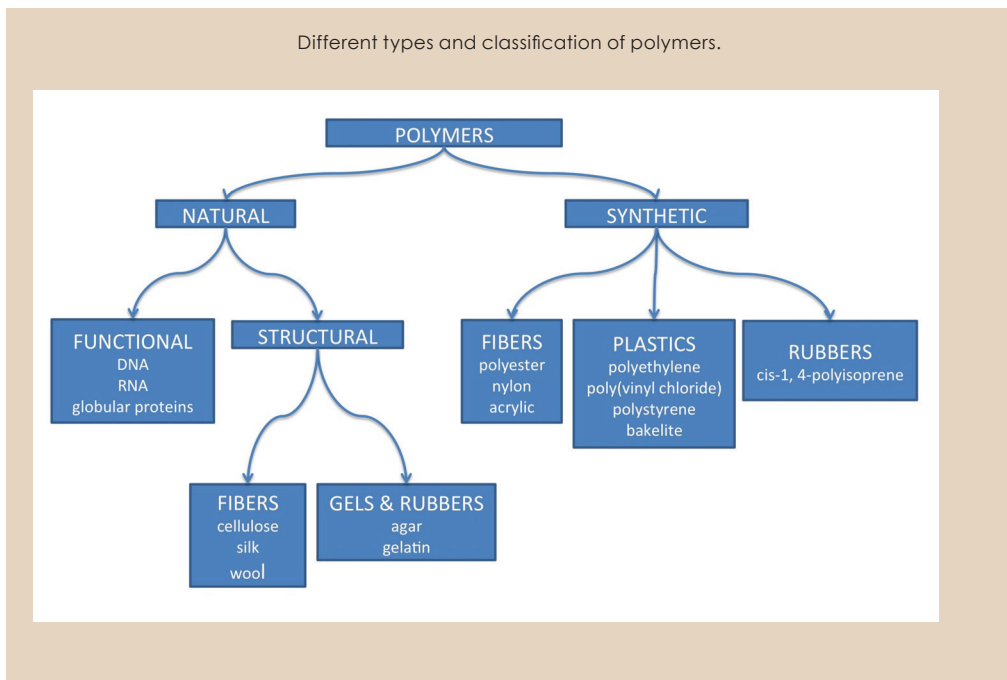

Polymers can comprise several linked repeating units (as in hydrocarbon fuels), or millions of repeating units (as in DNA). Useful natural polymers include cotton, wool, and silk. From an engineering standpoint, synthetic polymers are of greater interest because these polymers can be chemically altered or synthesized in controlled ways to have desirable properties.<sup>136</sup> Polymers can form crystalline structures, and also exist in liquid, amorphous, or a cross between amorphous and crystalline phases. By controlling the chemical nature and number of repeating unit(s), the properties of a polymer can be changed. Thus, the underlying molecular structures determine polymer properties.

135. D. William, Callister, G. David Rethwisch, *Fundamentals of Materials Science and Engineering: An Integrated Approach* (John Wiley & Sons, Inc, 2012).

136. D. William, Callister, G. David Rethwisch, *Fundamentals of Materials Science and Engineering: An Integrated Approach* (John Wiley & Sons, Inc, 2012).

Polymers tend to exist in more disordered forms than either metals or crystalline-state ceramics. The covalent nature of polymers gives their molecules great flexibility. Many of the macroscopic uses of polymers are the result of emergent properties that form as polymer molecules attempt to maximize bonding interactions, such as van der Waals forces (e.g., the hydrophobic effect). For materials at this scale, AEC is only significant when those materials find themselves in highly irradiative environments such as a nuclear reactor. Some special polymers, like graphene, have important properties that change depending on their actual molecular configuration. These polymers, like with any other material whose properties depend on the integrity of their atomic/molecular structures, are susceptible to only a few instances of AEC.

### Polymer Structures

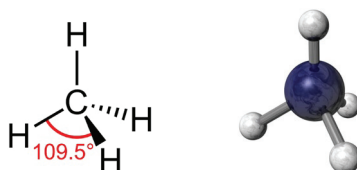

Tetrahedral bond geometry for the most simple hydrocarbon methane/Alex Taliesen

Common polymers are typically composed of hydrocarbon backbones, though there are other types of polymers with different backbones. DNA, for example, utilizes a phosphodiester backbone in order to achieve its polymerization of the component deoxyribonucleic acids. Organic polymers (with hydrocarbon backbones) occur naturally, but some of the more useful polymers are synthesized. For organic polymers, knowledge of the chemistry that describes their structures makes synthesis possible and controllable.

Hydrocarbons are molecules composed of carbon and hydrogen that have a string of connected carbons (i.e., carbon backbone) linked through covalent bonds. Carbon is located in the p-block within column IVA of the periodic table, and has 4 valence electrons. Carbon is small and relatively electronegative compared to most other metals and non-metals. The four valence electrons of carbon assume a tetrahedral geometry where the bond angle is  $109.5^\circ$ , as shown in the figure above. When carbon forms covalent bonds with hydrogen or other non-metals in this geometry, the 2-s and 2-p atomic orbitals hybridize into four  $sp^3$  orbitals that position the valence electrons in the tetrahedral geometry, as this is the most thermodynamically stable configuration. Rotation can occur around any of the four  $sp^3$  orbitals. This rotational flexibility allows long chains of hydrocarbons to have many bends and twists. The bending and twisting of long chain hydrocarbons can result in a random “folding” of hydrocarbons where sections of the chain are held together through a collective force derived from secondary bonds (e.g., van der Waals interactions). The degree of folding or aggregation in a hydrocarbon is a delicate balance between obtaining energetic gains (i.e., enthalpy) and the entropy of the polymer’s structure. The major factors that influence this structure are the polymer chain length, the connectivity of the repeating unit(s), and the chemical makeup of the repeating unit.

To better understand the chemical nature of polymers, let's start by looking at how simple hydrocarbons are put together. The compound ethane consists of two carbons covalently linked, and each of these carbons are bound by three hydrogens (see figure "Ethane three dimensional bonding structure," below). The bonding occurs between the hydrogen 1-s orbital and the carbons four  $sp^3$  orbitals. In this configuration the carbon can rotate freely around the C-C or a C-H bond, and will assume the conformation that minimizes steric hindrance between neighboring C-H bonds (see figure "Differing ethane rotational orientations," below). In ethane, this conformation is staggered. If a few other  $-CH_2$  groups are added to ethane, hexane can be made. Hexane has more degrees of rotational freedom and thus can assume more conformations. However, it is unable to form enough secondary bonds to formulate any type of amorphous or crystalline structure at normal temperatures.

The hydrocarbon backbones are not restricted to bonding schemes that force them into tetrahedral geometries with  $sp^3$  hybridized orbitals. The repeating units of hydrocarbons can also include carbons linked through double or triple bonds. Here the single bonds are formed with  $sp^2$  or  $sp$  hybridized orbitals, and the double and triple bonds are made through unhybridized p-orbitals. The introduction of double and triple bonds into polymers does two things: it creates more rigidity in the hydrocarbon backbone, and it provides a mechanism for delocalization of electrons (i.e., resonance), which is important for the electrical conductivity properties a polymeric material exhibits.

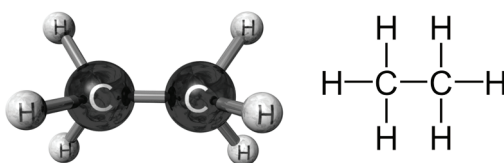

Ethane three dimensional bonding structure/Alex Taliesen

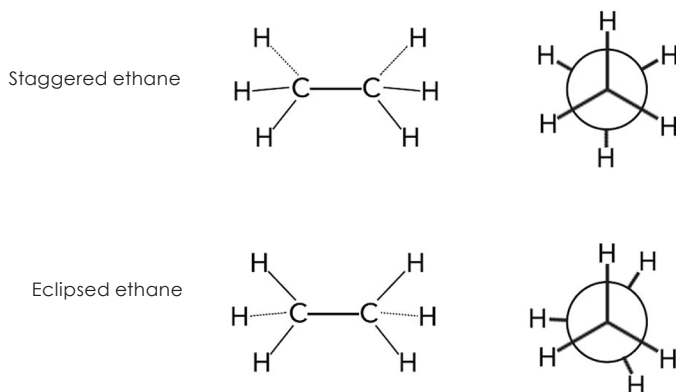

Differing ethane rotational orientations/Alex Taliesen.

The introduction of double and triple bonds to a polymeric backbone creates order within the molecular structure. Such bonds can establish “kinks” in the backbone that allow the polymer to retain a specific molecular orientation. The placement, frequency, and nature of the kinks thus can influence the material properties of a polymer. Additionally, carbons do not have to bond exclusively to other carbons and hydrogens. Part of any polymer or repeating unit within a polymer can consist of functional groups defined by covalent bonds with carbon and other non-metals such as nitrogen, oxygen, or the halogens. Because these functional groups contain non-metals, this formation creates polarization in the molecular structures. This polarization influences the material properties and chemical reactivity of the polymers. Different repeating subunits can be utilized in the construction of a polymer, and such polymers are typically referred to as copolymers because they are combinations of either different repeating units or smaller polymers of various lengths and composition (see figure below).

Alternating co-polymer:  
monomer units alternate.

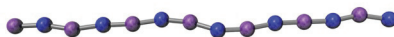

Random co-polymer:  
monomer units arranged randomly.

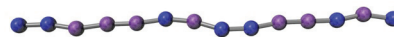

Block co-polymer:  
blocks of homopolymer units.

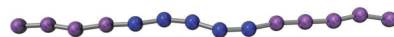

Graft co-polymer:  
homopolymer chains joined.

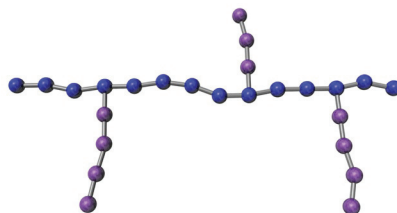

Different linkages of copolymers/Alex Taliesen

Considering their different structures and material compositions, polymers can take on a wide spectrum of properties. Many of the properties attributed to synthetic polymers depend on the unique mix of disorder and order within their molecular structures. Unlike other materials like metals and ceramics, science has not yet determined how to create polymers with specific molecular configurations; rather, properties are engineered through empirical processing techniques founded in chemical theory. Bulk properties of polymers can be fairly finely tuned, but getting a polymer to aggregate into a precise three-dimensional orientation every time is a very difficult and complicated task. To date, science can barely explain how an enzyme manages to fold into the same orientation during its synthesis, and enzymes are polymers whose end structure is precisely known.<sup>137</sup>

137. Ken A. Dill, S. Banu Ozkan, M. Scott Shell, and Thomas R. Weikl, “The Protein Folding Problem,” *Annual Review of Biophysics* 37 (2008): 289-316.

There is still a lot of science to be developed in the field of understanding the precise nature and mechanisms of how large polymers obtain stable orientations.

For more ordered polymers though, (i.e., those that have more crystalline structures) a great deal is known about how the atomic properties of the substances translate into the observed atomic structures. In general, the more “links” in a polymer chain, the more likely it will be that it can take on a solid-state structure. The principles behind this phenomenon explain why certain fats are liquid (e.g., oils) or solid (e.g., lard) at room temperature: the longer the hydrocarbon chain, the more secondary bonding interactions can take place that allow the different polymeric chains to stack into ordered structures. These are typically termed hydrophobic interactions. When hydrocarbons contain functional groups with electronegative non-metals, stronger dipole interactions between adjacent polymers can help create more rigidity within the material. Polymers can also have their chains covalently linked together in a process known as cross-linking. Order can also be established when polymers form networks utilizing a repeating unit with three active covalent bonds. It is important to remember, though, that unlike a metal the order established in polymeric networks and systems is somewhat random in nature. The same types of bonding patterns and structures form when polyvinyl chloride (PVC) is made, but each sample of PVC is unique in its precise network of atomic/molecular connectivity.

The atomic structures of metals and ceramics are made from atoms and ions, while polymeric molecular structures are made from molecules. This makes the nature of those polymers that do crystallize much more complex than other materials. The polymeric chains pack in unique ways to create vast atomic arrays, and some of these have useful emergent properties at the micro- and macroscales. Typical polymer crystals consist of regions that contain both amorphous and crystalline regions (see figure below). The amorphous regions of polymeric chains are twisted, coiled or kinked; and the crystalline regions are more ordered structures held in place through various bonding patterns. The

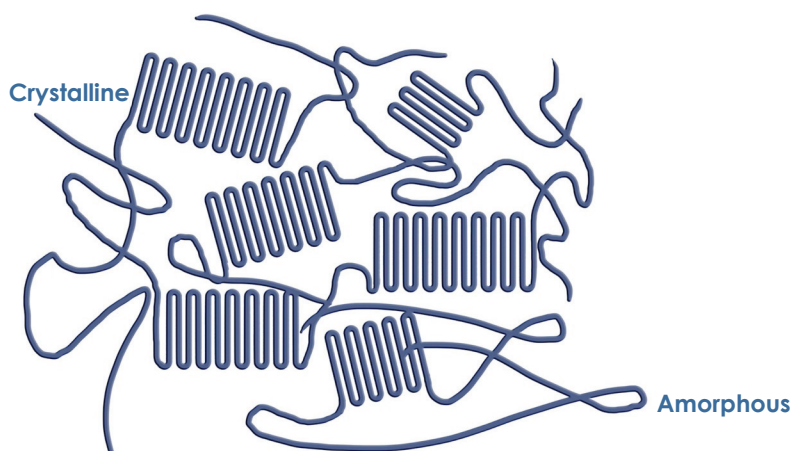

Polymer with both amorphous and crystalline structures/Alex Taliesen

more complex the chemical properties of the repeating unit in the polymer, the less likely it will crystallize. Cross-linked polymers are also less likely to obtain crystalline structures because the covalent linkages prevent the necessary rearrangements needed for crystalline formation. The differences between crystalline and non-crystalline polymers are similar to those of ceramics. A crystalline polymer is typically stronger, less ductile, and a better conductor of heat and/or electricity.

The impact of AEC on polymers such as plastics is distinctly different than what occurs in other materials. Polymers are generally used for to their macroscopic properties, and those properties tend to depend on the length of the polymeric chains that make them up. Atomic effects on polymers can result because interactions with, for example, high-energy gamma photons can break the covalent bonds in the polymer's backbone. This in turn reduces the average molecular weight of the polymeric chains and allows the polymeric system to take on more disorder. Plastics in radioactive environments are known to degrade this way, essentially being "cut" into smaller polymeric pieces by high-energy particles.<sup>138</sup> Additionally, polymers are finding new uses in more high-tech applications such as organic semiconductor materials. As with metals and ceramics, when a material's property (e.g., information storage/processing) depends on the specific orientation of its underlying atomic/molecular structure, AEC is a serious concern.

### *Polymer Properties*

The majority of synthetic polymers have properties characteristic of plastics and rubber. Generally, synthetic polymers are not very strong or stiff, are ductile, are easily formed into complex shapes, are relatively inert chemically, and are resistant to traditional electrochemical corrosion. These polymers find applications from structural materials, to coatings, to films. Normally the structures of polymers lack the necessary arrangements needed for delocalization electrons to conduct electricity. However, recent advancements in polymer science have enabled the study of polymer properties at the atomic scale making it possible to synthesize polymers that have more desirable properties such as semi-conductivity. This bottom-up science approach is likely to lead to expanding the use of polymer materials, and also to a new reliance on properties that are more characteristic of the individual polymer chains than their macroscale properties.

---

138. "The Effect of Nuclear Radiation Exposure to RT/duroid PTFE-Based Composites," *Rogers Corporation*, 2015, <https://www.rogerscorp.com/documents/753/acs/The-Effect-of-Exposure-of-RT-duroid-PTFE-Based-Composites-to-Nuclear-Radiation.pdf>.

## Plastics and Other Polymers

### Amorphous Solids (Polymers)

#### Different Monomers

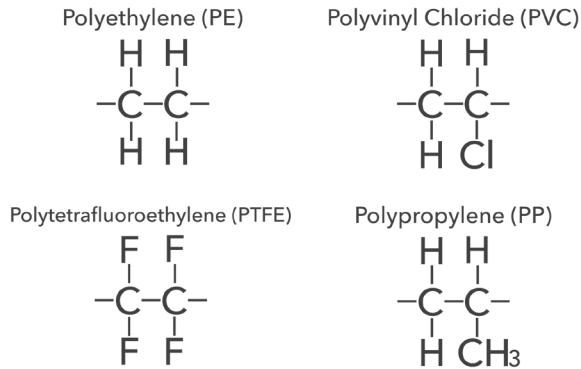

Structures of different types of monomers for plastics/Alex Taliesen

Plastics (see figure above) such as polyvinyl chloride (familarly known as PVC), polystyrene, polyesters and epoxies all exhibit a range of material properties. These properties manifest from the degree of crystallinity these materials form at various scales. Linear, branched, cross-linked, and networked assortments of polymeric chains will exhibit different properties because their molecular arrangements determine the ways in which these chains can pack and crystallize. Ordered structure is necessary for electrical conductivity and strength, but this degree of order is not important to a material's ability to be molded into any shape. Plastics such as polystyrene are used in applications that require a material with optical transparency; this property is actually dependent on the amorphous nature of these structures. Amorphous or fluid-like materials have a disordered microstructure and are less susceptible to the impacts of a few occurrences of AEC because the phenomena that tend to cause atomic effects create disorder in an ordered system. What matters in these materials is the frequency at which they experience AEC: there is a threshold at which enough AEC can accumulate to make a discernible difference in a polymer's behavior. If that threshold is not reached during a material's design life-cycle, then what matters is the extent AEC aids other degradation phenomena (i.e., classical corrosion).

Elastomers are polymers that give us materials such as rubber. The elastic properties of these materials depend on the molecular structures formed during processing procedures such as vulcanization.<sup>139</sup> Arguably one of the most important elastomers is styrene-

139. "Vulcanization," *Wikipedia*, Modified 15 Sept 2015, Accessed 28 Sept 2015, <https://en.wikipedia.org/wiki/Vulcanization>.

butadiene copolymer, which is used to manufacture automobile tires; this elastomer is improved with the addition of carbon black to have increased tensile strength, wear and tear resistance, and stiffness.<sup>140</sup> Silicone elastomers possess a high degree of flexibility and are resistant to the damage induced by wear and tear, making them potentially useful materials in things such as automobile engine components. All elastomers are by nature cross-linked, and their elastic properties depend upon the degree to which they can form ordered molecular structures. Elastomers, just as steels used in nuclear reactors, can be better designed to withstand both the direct and indirect effects of AEC.

The other important polymer category is polymeric fibers. These fibers are used mainly in textiles, which means they have important roles in the material properties of DoD systems such as tents and clothing. The use of polymers as fabrics requires that they possess properties that allow for deformation, elasticity, high-tensile strength, and limited chemical reactivity. These properties are determined by the chemical nature of the polymer chains and the degree of crystallinity in the polymer structure. The properties of fibers will deteriorate in the presence of phenomena that cause AEC, just as will any other polymer.

Polymers are used as coatings, adhesives, films, and foams, among other things. The many different uses of polymers reflect the degrees of crystallinity that can form with polymeric chains of varying sizes and chemical compositions. For the different types of materials derived from polymeric hydrocarbon chains, the mechanical properties are the manifestation of their molecular structures. Changes to their structures will have varying degrees of impact on the materials' capabilities. If science can achieve the ability to understand how material properties manifest from the "bottom-up," then we can custom design new polymers and polymeric materials. Learning how the properties of polymers emerge from their molecular underpinnings will also reveal how AEC can cause the degradation of these materials. By investigating the mechanisms of AEC in polymers from the bottom up, new information about the causes of failures can be identified and incorporated into predictive models. These models can then be used to more accurately determine a material's reliability.

### *Advanced Polymers*

As polymers are understood in greater detail at the atomic scale, new techniques are being invented to control the assembly of various polymeric molecular architectures, and thus create advanced polymers that have desirable properties. For example, ultra-high-molecular-weight polyethylene (see Figure 31) has molecular weights on the order of  $4 \times 10^6$  g/mol.<sup>141</sup> This material is currently being utilized as a component of bulletproof

---

140. "Styrene-butadiene," *Wikipedia*, Modified 5 Sept 2015, Accessed 12 Sept 2015, <https://en.wikipedia.org/wiki/Styrene-butadiene>.

141. "Ultra-high-molecular-weight polyethylene," *Wikipedia*, Modified 7 Aug 2015, Accessed 2 Sept 2015, [https://en.wikipedia.org/wiki/Ultra-high-molecular-weight\\_polyethylene](https://en.wikipedia.org/wiki/Ultra-high-molecular-weight_polyethylene).



vests and military helmets. It is also used in valve gaskets, golf-ball cores and other technologies. This form of polyethylene is versatile, but due to its high molecular weight it is sensitive to phenomena that can cause covalent breakage of its long polymeric chains. Such phenomena can include heat or radiation (i.e., AEC).

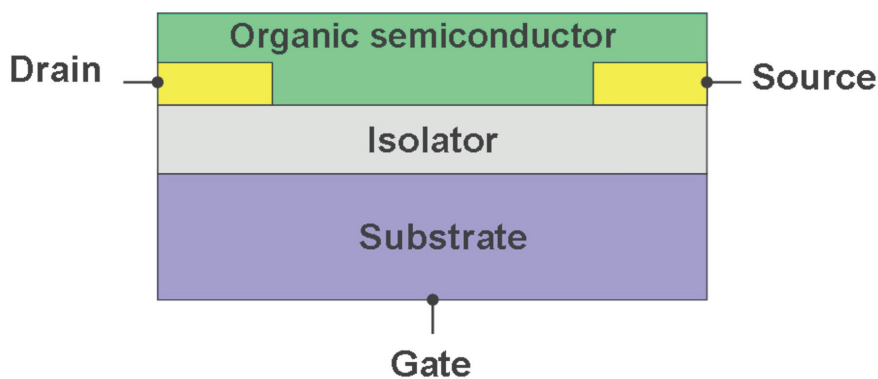

Schematic of an organic field effect transistor/Materialscientist

Recently, polymers have been explored for their use as organic semiconductors.<sup>142</sup> In silicon, the crystal lattice structures are virtually perfect, and it is relatively easy to manipulate the physical environment around silicon crystals to move electrical charges. Therefore, silicon based semiconductors are currently the backbone of microelectronics. The problem is that silicon semiconductor manufacturing requires complex, multi-layer processes, and developing efficient manufacturing processes is becoming increasingly difficult as feature sizes decrease. Organic semiconductors offer the advantage of realizing complex electronic circuits with a single semiconducting layer, deposited by simple coating techniques. The problem is that organic polymers' crystal lattice structures are far from perfect, and constructing polymeric materials that have semiconducting properties efficiently has been a huge challenge. If this challenge can be overcome, polymers that are much simpler to manufacture can be used in microelectronics and other advanced technologies.<sup>143</sup>

The problem with polymers is that in order to have a useable semiconducting property, the conjugated pi-electron orbital systems of organic polymeric molecules must exist in a state that can mimic the delocalization network of traditional inorganic semiconducting materials like silicon. The rates of current transfer through conjugated pi-electron systems currently lag the rates possible with silicon-based semiconductors. However, manufacturing organic electronic materials is much simpler and less costly than traditional silicon/metallic materials. Furthermore, organic materials can be used to create what is known as "flexible electronics," which have many potential uses.<sup>144</sup> For example,

142. Giorgio Dell'Erba, Alessandro Luzio, Dario Natali, Juhwan Kim, Dongyoon Khim, Dong-Yu Kim, Yong-Yong Noh, and Mario Caironi, "Organic integrated circuits for information storage based on ambipolar polymers and charge injection engineering," *Applied Physics Letters* 104, No.15 (16 April 2014).

143. I.G. Hill, D. Millron, J. Schwartz, and A. Kahn, "Organic semiconductor interfaces: electronic structure and transport properties," *Applied Surface Science* 166 (2000): 354-362.

144. Alan S. Brown, "Flexible electronics could transform the way we make and use electronic devices," *Pennsylvania State University*, April 8, 2013, <http://news.psu.edu/story/272086/2013/04/08/research/flexible-electronics-could-transform-way-we-make-and-use-electronic>.

developers have been working on “wearable computers” for years; organic electronics could make them significantly more affordable. For organic electronics that are likely to be low processing (e.g., display electronics) and inexpensive, their degradation due to AEC mechanisms will be less of an issue in terms of material sustainment – at least in environments where they can be easily replaced.

If major breakthroughs occur in the science of organic semiconducting materials, the result could be organic transistors that perform as well as their inorganic counterparts. We already know that the electrical properties of organic semiconductors degrade due to the effects of gamma radiation, but it is not clear why that is so.<sup>145</sup> One “educated guess” is that these atomic effects create disorder that disrupts the ability to establish the needed conjugated pi-electron system in these materials. But if newer, high-speed organic electronics are developed, and these remain susceptible to AEC, then it will be important to understand the degradation mechanisms induced by AEC<sup>146</sup>. The point is that as organic semiconductors are developed, it is also necessary to explore the degradation mechanisms that may affect their performance and longevity. Given the potential versatility and cost-effectiveness associated with organic microelectronics, there could be a successful future for these technologies in critical DoD systems. Thus, it is in DoD’s interest to further research such materials, and to consider the impacts AEC can have on the reliability of such materials.

## COMPOSITES

Composites are unique hybrids of materials that contain elements of metals, non-metals, and polymers. Composites can degrade as other materials do, and the impacts of small changes in the molecular structures of these materials could contribute to their eventual macroscopic failure. If and when these materials are used at the micro and nano scales, atomic effects may result in degradation of a composite’s desired properties to a level that is unacceptable for the particular needs of that material. So we cannot rule out significant AEC in composites. Given the complex atomic structures and variety of chemical structures contained within composites, however, the investigation and discussion of degradation in composite materials is deferred to the next book addressing biological effects corrosion.

---

145. L.G. Kaake, P.F. Barbara, and X.Y. Zhu, “Intrinsic Charge Trapping in Organic and Polymeric Semiconductors: A Physical Chemistry Perspective,” *The Journal of Physical Chemistry Letters* 1, No. 3 (2010): 628-635.

146. Dalaver Anjum, Rachid Sougrat, Kui Zhao, and Aram Amassian, “Investigation of radiation effects on the properties of organic semiconductors using low-dose TEM analysis,” *Microscopy and Microanalysis* 18, No. 2 (May 2012): 1436-1437.

# APPENDIX 2

## AEC In DoD Military Infrastructures and Systems Containing Microelectronics

This appendix provides examples of atomic effects corrosion (AEC) degrading system functionality. The appendix is organized into two parts: the first part discusses AEC in microelectronics; the second part discusses AEC in the nuclear reactors on Navy submarines. The purpose of the appendix is to provide illustrative examples for which AEC matters to the sustained operation of DoD systems and infrastructure.

In 1958 the Department of Defense, in collaboration with the Department of Energy, conducted a nuclear test series under the designation Operation HARDTACK in the Pacific Ocean and Nevada. This series of 35 tests occurred in three parts.<sup>1</sup> The first part was an examination of the basic effects on ground motion, structures, and materials following a nuclear blast from megaton devices. The second part was aimed at studying the effects of nuclear blasts underwater. The third part was aimed at understanding nuclear weapons in air and ballistic missile defense.

Project 6.3 in Operation HARDTACK was affiliated with the first part of the series. This project had three objectives, stated as follows:

*“(1) expose electronic component parts and materials that are used in ordnance electronic fuzes to the same radiation environment that will be experienced by the fuzes when they are tactically operated or stored in the vicinity of a nuclear detonation; (2) evaluate the performance of component parts and materials under simulated operating conditions before, during, and after a detonation; and (3) evaluate the behavior of an operating captive, typical guided missile fuze system (Corporal) when exposed to the same radiation environment as the individual electronic component parts.”<sup>2</sup>*

These tests were analyzing the effects of radiation following neutron fluxes of 1012 neutrons/cm<sup>2</sup> s and 10,000 Roentgen (which is approximately 93 Sievert; Sv) of gamma radiation. The results of this test series led to the conclusion that the reliability of electronic systems operating in the vicinity of a nuclear blast will likely be compromised.<sup>3</sup> Although the precise mechanisms for radiation-induced failures in electronic systems were unknown, by 1961 the DoD knew that electronic systems could degrade due to the effects of radiation.

- 
1. Defense Nuclear Agency, “Operating HARDTACK I,” *Department of Defense* (1958), <http://www.dtic.mil/dtic/tr/fulltext/u2/a136819.pdf>.
  2. E.E. Conrad, B.J. Dobriansky, A. Simon, R.W. Tucker and F.N. Wimenitz, “OPERATION HARDTACK, Effects of Nuclear Radiation on Electronic Fuze Components and Materials,” *Defense Technical Information Center* (April – Oct 1958), <http://www.dtic.mil/docs/citations/ADA995242>.
  3. Defense Nuclear Agency, “Operating HARDTACK I,” *Department of Defense* (1958), <http://www.dtic.mil/dtic/tr/fulltext/u2/a136819.pdf>.

The B-52, Navy A4D, and Navy F54 aircraft were also tested to determine the radiation effects on their structural components. No measurements regarding the impacts on the micro- or nanostructures within these aircraft materials were recorded because the necessary technologies to do so did not exist. Despite this limitation, it was clear that material properties could degrade due to exposure to high-energy radiation environments, such as those that exist following a nuclear blast.

In sum, AEC is not a new phenomenon, we now do have the means to measure impact on micro- and nanolevel structures, and we propose that it is time to recognize AEC's importance in the corrosion spectrum in order to combat the total impact of corrosion on DoD equipment, infrastructures and systems. AEC can directly destroy nanomaterial capabilities, and can indirectly act as a catalyst or nucleating event that leads to accelerated microscopic and macroscopic material failures, in both cases resulting in a loss of

**AEC is not a new phenomenon, but it is time to recognize its importance in the corrosion spectrum.**

capabilities. The purpose of this appendix is to examine these two degradation pathways in detail within the context of the equipment, infrastructures, and systems that are important to our military forces. To do so, we have chosen two illustrative examples: we discuss direct damage effects to microelectronic systems, and indirect damage effects to Navy nuclear powered submarines.

## **DIRECT AEC DAMAGE: LOSS OF CAPABILITY IN MICROELECTRONIC MATERIAL PROPERTIES**

This section will provide a more in depth analysis of how materials degradation in microelectronics due to AEC can adversely affect military equipment, and to emphasize the importance of creating an appropriate material sustainment strategy to combat these impacts. This section is divided into four parts that together provide a complete "story" of AEC in specific DoD assets that contain microelectronics.

First, we present a historical context regarding the relationship between DoD capabilities and microelectronics, to provide background that demonstrates the importance of reliable, trusted microelectronics in DoD assets. Second, we describe the fundamental components of microelectronics systems in order to establish the scientific underpinnings for explaining how these component parts can be destroyed by phenomena associated with AEC, and how these phenomena can lead to failures in critical DoD equipment.

Third, we provide examples of two types of AEC degradation that can degrade the core components of any state-of-the-art microelectronic component; the point is to demonstrate the importance of a material sustainment strategy that incorporates the impacts of AEC. Due to the almost ubiquitous nature of microelectronics in many DoD assets and the continued application of even more advanced microelectronics, we do not discuss the microelectronics in a specific system, but rather the mechanisms that can lead to the destruction of virtually any microelectronics component. A complete description of how AEC can lead to the failure of each of the microelectronic systems within a complex

system such as the F-35 (Joint Strike Fighter), for example, would warrant an entire book in and of itself.

Fourth, the final part of this section focuses on preparing a material sustainment strategy for AEC. In this we discuss current approaches to predicting failures due to AEC and how these can be incorporated into the CPO's corrosion prevention and control strategies to create a more complete material sustainment strategy that combats materials degradation mechanisms throughout the corrosion spectrum.

### *History of Microelectronics in Military use*

Many would argue that no technology advance of the twentieth century transformed the capabilities of the United States military as much as microelectronics. In less than a generation, microelectronics have enabled massive advances in the communications technologies, radar detection systems, and computing capabilities, to name a few examples, compared to what we had during WWII and the Korean War. The electronic systems of the past were limited in their performance by factors such as the size restrictions of electronic circuit components (e.g., capacitors, vacuum tubes, individual transistors, and so forth). The need for higher performance electronics led the DoD to invest heavily in miniaturizing the components of electronic systems.<sup>4</sup> Without these investments by the DoD, it is quite likely the microelectronics industry would be decades behind where it is today.

A primary goal in microelectronics has always been miniaturization. The smaller you can make components for an electronic circuit, the more components you can put into a given volume (e.g., on a single chip) and the more complex configurations can be designed. The ability to increase the density of components and complexity of design features led to many new capabilities of microelectronics that were not possible in 1904 when the first diode was invented by John Ambrose Fleming.<sup>5</sup> In fact, it was the invention of the first bipolar transistor in 1948 at Bell Telephone Laboratories<sup>6</sup> that made the field of microelectronics possible. Until that time, transistors, the switches in electronic circuits, were bulky and required the use of vacuum tubes. The bipolar transistor created the ability to move electrons in a controlled manner through a solid state rather than a vacuum tube system. This was the crucial first step needed for miniaturization.

The original bipolar transistors were about the size of dice (ridiculously large by today's standards, but orders of magnitude smaller than vacuum tubes); over time, advances in transistor design enabled size reductions to the point that they were eventually the size of a spec of dirt. As transistors began to approach the size at which they could not be seen with the naked eye, a new problem began to emerge. The components on an electrical circuit are connected through pieces of metal known as interconnecting wires (or simply interconnects). These interconnects are the roads by which electrical current can

4. John D. Moteff, "The Role of DoD's Investment in Electronics on the Decline of the Consumer Electronics Industry," *Industrial College of the Armed Forces* (Washington DC: Aug 1995- Aug 1996), <http://oai.dtic.mil/oai/oai?verb=getRecord&metadataPrefix=html&identifier=ADA314887>.
5. DoD DMEA Microelectronics Trusted Source," *Zephyr Photonics*, 2015, Accessed 28 Sept 2015, [https://en.wikipedia.org/wiki/John\\_Ambrose\\_Fleming](https://en.wikipedia.org/wiki/John_Ambrose_Fleming).
6. Peter Ashburn, *SiGe Heterojunction Bipolar Transistors* (England: John Wiley & Sons Ltd., 2003), 1, 2.

travel, and the complex orchestration of the flow of electricity through the circuit gives it the ability to do things such as compute and store information. As components became smaller, more components could be placed onto chips, but this led to a problem of numbers of interconnects. At the time, chips were assembled by hand and the military requirements for chips were becoming sensitive enough that consistency in interconnect length and thickness (and thus electrical resistance) began to matter. What this meant was that a new method of chip manufacture was needed that didn't require circuits be built by hand.

In 1959, Jack Kilby of Texas Instruments helped solve this problem with the invention of the integrated circuit (IC).<sup>7</sup> This pursuit was driven largely by the needs of the space race and demands associated with the Cold War. In the 1960s, the DoD's Minuteman program, a nuclear-armed ballistic missile program, required approximately 4000 ICs per month.<sup>89</sup> This program was needed to ensure military superiority during the cold war by deterring other nations from engaging in open conflict with the United States for fear we could overmatch them in a nuclear exchange.<sup>10</sup> At the same time, the DoD was also investing heavily in the development of satellites for multiple purposes, from communications to surveillance to remote sensing. Combined, these programs meant that the DoD required not just more, but better, miniaturized electronic components. Increased funding into microelectronics R&D resulted in the development of new transistors and ICs that created breakthroughs in new applications such as phased array radar and smaller-scale computer technologies; improved ICs enabled the higher processing speeds required to make these new systems viable.

By the 1970s, following the DoD's support of the very high-speed integrated-circuit (VHSIC) program, major weapons systems began to incorporate increasing numbers of electronic components, leading to improved capabilities. ICs were included in numerous advanced systems, such as the F-16 fighter, Trident ballistic missile submarine, and also smaller systems such as Stinger, Maverick and TOW guided missiles.<sup>11</sup> As DoD systems incorporated ICs, commercial IC applications were also becoming a viable market for industry. As commercial IC applications expanded, industry began regarding commercial applications as a lucrative marketplace. As a result, DoD eventually lost the leadership role in the microelectronics market. With commercial applications driving advances in microelectronics, DoD struggled to ensure the defense systems that relied on microelectronic components incorporated the latest state-of-the-art microelectronics. Furthermore, as commercial markets continued to develop, "disposable" electronics became more common: why would a consumer try to maintain the \$100 electronic calculator when he could replace it with a better model for \$20. Such economies were not available, however, for sophisticated weapons systems. Thus, the DoD was faced

7. "The History of the Integrated Circuit," *Nobelprize.org*, May 5 2003, Accessed Sept 29, 2015, [http://www.nobel-prize.org/educational/physics/integrated\\_circuit/history/](http://www.nobel-prize.org/educational/physics/integrated_circuit/history/).
8. John D. Moteff, "The Role of DoD's Investment in Electronics on the Decline of the Consumer Electronics Industry," *Industrial College of the Armed Forces* (Washington, DC: National Defense University, 1996).
9. "Minuteman Missile History," *Strategic-Air-Command*, Accessed 29 Sept 2015, [http://www.strategic-air-command.com/missiles/Minuteman/Minuteman\\_Missile\\_History.htm](http://www.strategic-air-command.com/missiles/Minuteman/Minuteman_Missile_History.htm).
10. "Air Force Histories Released through Archive Lawsuit Show Cautious Presidents Overruling Air Force Plans for Early Use of Nuclear Weapons," *The National Security Archive* (George Washington University, 30 April 2008), <http://nsarchive.gwu.edu/nukevault/ebb249/>.
11. *Ibid.*.

with the need to maintain sophisticated systems for long life-cycles in a microelectronics market that was simply throwing out old devices and replacing them with newer, better, less expensive models. Yet even with regard to microelectronics components, DoD could not simply insert newer commercial ICs because they were not compatible with other existing system components. In sum, the DoD faced a dilemma: it was costly to custom build their own state-of-the-art microelectronic components, but they could not simply swap out the more affordable state-of-the-art microelectronics designed for commercial applications.

This problem still exists within the DoD today. High-volume microelectronics are designed almost exclusively for commercial applications, and new generations of microelectronics emerge every few years. On the other hand, the DoD has to integrate electronic components into sophisticated systems, such as the like the F-35, that take years to develop. As a result, the microelectronics in many new systems are out of date compared to commercial designs before the new systems are even fielded. In order to manage the costs associated with fielding and maintaining sophisticated systems, microelectronic components must last much more than the few years common to commercial microelectronic systems.<sup>12</sup> Thus, understanding all the ways in which microelectronic components can degrade, to include considering the harsher environments in which DoD systems must operate, is extremely important. This means the DoD must understand the impacts of AEC on systems containing microelectronics components, and develop material sustainment strategies to prevent their premature failure, thus ensuring they function reliably when the military needs them.

### *Microelectronics Basics*

Microelectronics, as the name suggests, are made of the same basic components as traditional electronics – e.g., transistors, resistors, capacitors, inductors, and diodes – except their individual component dimensions are many times smaller than can be seen by the naked eye. In recent years, components have reached sizes of less than 10 nm, which is well within the range where single atom defects can adversely affect a component's performance. This section will briefly review the various types of basic components used in microelectronics, how they function, and some of their common uses. Understanding how a system's components work helps to understand how the components can fail, and the consequences their failures can have on the overall system.

**DoD has to integrate electronic components into sophisticated systems that take years to develop.**

Electronics are so named because they make use of the flow of electrons in materials: for example, making calculations and storing information by moving electrons around and placing them in specific locations. Individual components interact with each other, and external users interact with the electronics system as a whole; electric potential differences, also known as voltages, make the movements of electrons and interactions of electronic components possible. In the next few paragraphs, we briefly overview electronic component functions.

12. Department of Defense, "Department of Defense Assured Microelectronics Policy," *Office of the Under Secretary of Defense for Acquisition, Technology, and Logistics*, July 2014.

Resistors resist the flow of electric current, and in doing so generate a measurable voltage drop as electric currents move through resistive components.<sup>13</sup> All objects have a natural resistance to electric current; the amount of resistance depends on the specific material, as well as the size and shape of the object. When used in electronics, resistors must have a specific, known resistance so that designers can predict what voltages need to be applied to achieve desired results. In normal electronics, the type of material is the main factor in determining the value of an individual resistor, but as microelectronics become smaller and smaller, the size and shape of a resistor takes over as the dominant factor determining the value of a resistor. The dimensions become so small, in fact, that even the electrical resistance of components not used as resistors must be carefully taken into account. Therefore, considering the electrical resistance of all microelectronics components influences the design and physical layout of the entire system. Since the typical distance between two atoms in a microelectronics component is roughly half a nanometer, when entire component sizes are only 10 nanometers or less, a change in the properties of one atom in that component can change the dimensions of that component significantly, and in turn alter its resistance.

The purpose of capacitors in electronics is to store charges (electrons and positively charged ions). They are composed of two pieces of electrically conductive material, the electrodes, which are separated from each other by an electrically insulating material, the dielectric. These individual electrodes are then connected to the circuit. Applied voltages cause electrons to accumulate on one electrode, which causes an excess amount of electrical charge and attracts positive ions in the other electrode towards it. The insulating material between the electrodes, however, prevents the electrons from travelling directly between the electrodes. It is only when the electrodes are connected to the circuit, and a full path through conductive material opens up, that the electrons can flow from the electrode where they have been stored to the other electrode, and balance the electric fields. In order for a capacitor to function correctly, electrons must not be able to pass directly between the two electrodes, thus the dielectric is a critical part of the capacitor. On the macroscopic scale, many materials are sufficiently insulating that passing an electric current through them is extremely unlikely. However, when capacitor dimensions are reduced to only a few nanometers thick, there are very few materials capable of preventing at least a few electrons from passing through them. Furthermore, some dielectrics can increase the amount of charge a capacitor can store, not through stronger insulation, but instead through the ability to polarize, meaning that even smaller degradations in their performance can allow them to pass current and cause the capacitor to fail. Capacitors designed for today's microelectronics have extremely exacting properties, and even slight deviations can cause significant changes.

Inductors are coils of wire and they function to resist changes in electrical current; that is, inductors are used to smooth out fluctuations in current. Inductors are used almost exclusively in analog circuits. In the current digital age, analog circuits are becoming

---

13. Because of Ohm's law, which states that the size of the voltage in an object is proportional to the size of the current flowing through that object, multiplied by the resistance of that object:  $V=IR$ .



increasingly rare, but there are still specialized applications, such as communications and signal recording, in which inductors are used. Faraday's law states that any change in an electric field (or current) generates a magnetic field, therefore an inductor generates magnetic fields when operating. These magnetic fields extend into the region surrounding the inductor. Magnetic fields, especially changing ones, are often dangerous to electronics. Engineers attempt to take magnetic field generation into account when designing microchips that use inductors; however, engineering models are neither completely accurate, nor do they always account for the fields produced by a misfiring or improperly operating inductor. Inductors thus present not only the risk of degrading themselves, but in the process of degrading also induce the added risk of their magnetic fields causing the degradation of surrounding materials. As inductor dimensions become smaller to meet the demands of modern state-of-the-art microelectronics, the integrity of their underlying lattice structures increases.

Diodes function as one-way gates. Today's diodes are almost exclusively solid-state, made from semiconductors. The way that unidirectional current flow is achieved is by sandwiching two pieces of the same material together. One piece, however, has been doped with atoms that add extra electrons to the material (called n-doped), while the other piece has been doped with atoms that add extra holes (called p-doped). When the two pieces are placed in contact with each other, the extra electrons and holes in the region surrounding the contact point can move across the contact boundary and cancel each other out. The region around the boundary where this charge cancellation happens is called the "space-charge region." The movement of electrons and holes across the boundary is mainly possible because the n- and p-type pieces are made of the same material, which minimizes other differences that would restrict such electron movement.

In the resulting setup, illustrated in the figure below, one side of the diode has excess holes to carry electrical current, and the other side of the diode has excess electrons to carry current, but the center of the diode has a region with no particles available to

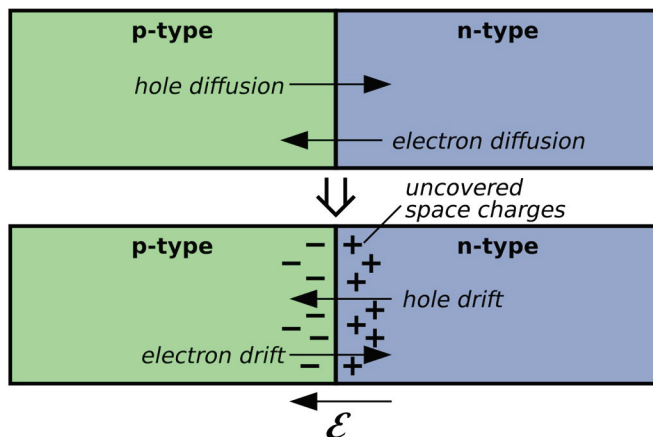
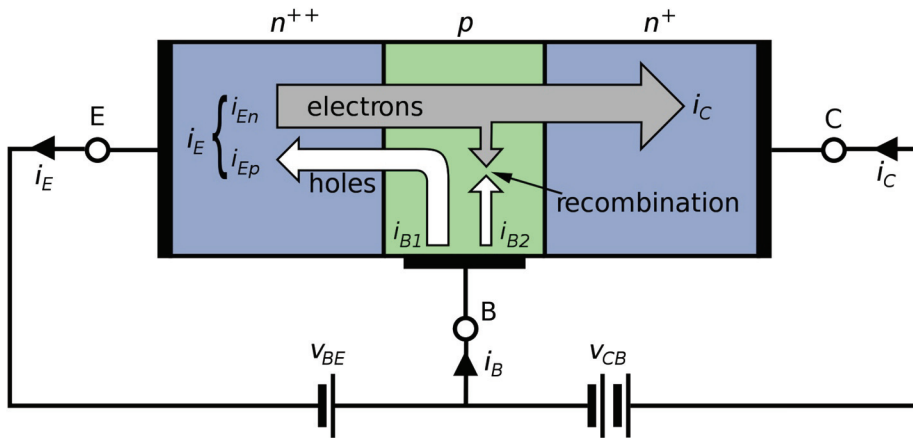

Diagram of the diffusion across a pn junction, with the resultant uncovered space charges, the electric field and the drift currents/Inductiveload

carry current. When the diode is hooked up to a circuit, however, if the voltage is placed across the diode in one direction (left to right, for example, in the figure below) then it pulls some of the electrons back over to the n-doped side, which shrinks the space-charge region, allowing current to flow in that direction across the diode. If the voltage across the diode is in the other direction, however, more electrons will be pushed into the p-doped side and will simply fill the holes, and the circuit will not conduct current. One can also think of the voltage as causing the space-charge region to grow, strengthening



The basic operation of an NPN BJT in Active mode/Inductiveload

the blockade for current across the diode. The purpose of a diode is to allow current to flow in one direction but not the other. For diodes, and p-n junctions in general, the properties of the p- and n-doped regions must be controlled in order to work properly. AEC that causes degradation of either side, or of the space-charge region in the center, can either cause the blockade to break down and allow current to flow in both directions, or to persist when it should not and therefore block all current from flowing.

By far the most common component in microelectronics is the transistor. A transistor acts like a gate for electrical current. When the gate is open, the transistor can conduct electrical current. When the gate is closed, current will not flow through it. To achieve this function, transistors use the advantages of doping, similarly to the p-n junctions used in diodes.

The most basic type of transistor is a bipolar junction transistor (BJT), and it is formed by two similarly doped regions of a semiconductor separated by a thin region of oppositely doped semiconductor. It is very similar to placing two p-n junctions next to each other. The outer pieces can be electron doped, called an n-p-n type, or they can be hole doped, called a p-n-p type. Figure 2 shows the basic design of a BJT. For explanation

purposes, we will describe an n-p-n type BJT. This type of transistor differs from two simple diodes connected to each other in opposite orientations in that one of the n-type regions is more heavily doped than its counterpart. The more heavily n-doped section is called the emitter and the less heavily n-doped section the collector, with the p-doped region in between called the base.

The mismatch in doping levels between the two electron rich regions means that current will naturally flow from the emitter to the collector, however the opposite doping in the base prevents this. The base is electrically connected to the rest of the circuit as well, and a voltage applied to it determines how high or low its resistance is to the flow of electrons from the emitter to the collector. When the resistance is low the gate is open, and when the resistance is high the gate is closed.

The amount of voltage needed to control the base in a BJT is extremely small, especially compared to the voltage difference across the junction that can be achieved, meaning that a small change in voltage can control a much larger change in voltage, making BJT transistors extremely useful for amplifying signals, as switches, or as components of logic circuits. Because the difference in doping of the n-regions is what makes the BJT work, it is inherently designed to only work in one direction, different from the other basic type of transistor (the field effect transistor), which can work with current flowing either direction.

The figure below shows the layout of a field effect transistor (FET). Instead of an emitter and collector, electricity flows through a transistor from the source region into the drain region. The source and drain regions are surrounded by what is commonly called the bulk region. Just as with the BJT, we will describe the case when the source and drain regions are n-doped and the bulk is p-doped, but FETs can also have p-doped source and drains, with an n-doped bulk. A thin layer of insulating material is placed on the surface of the bulk between the source and drain. A conductive material is then placed on top of the insulating layer, forming what is called the "gate."

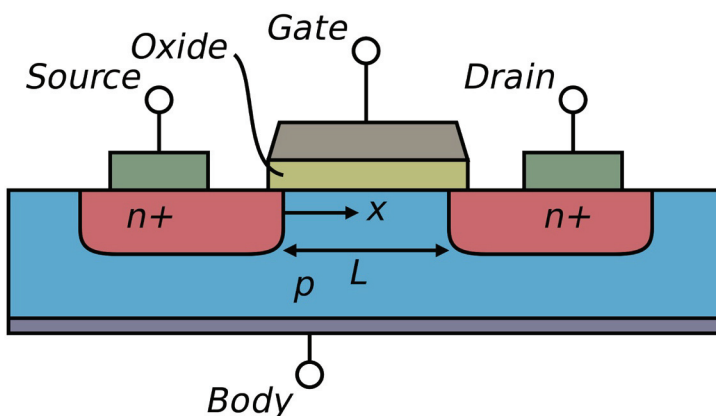

Field effect transistor of the n-p-n type/ Cyril BUTTAY

Both electrons from the source and drain, and holes already present in the bulk, populate the region in the bulk directly between the source and drain. These opposing charges cancel each other out, so that no charge carriers remain to conduct current within that region, named the charge depletion region. Both the source and drain are equally doped, meaning that when the transistor is not connected to anything, there is no electric field that would cause current to flow between them. However, when voltage is applied between the source and drain regions, a current can flow through the bulk, around the charge depletion region. Applying a voltage to the gate can have two different effects on the transistor: negative voltage applied to the gate, brings more electrons near it, expanding the charge depletion region and cutting off the flow of current through the bulk; positive voltage applied to the gate pushes electrons away from it, shrinking the charge depletion region and allowing more current to flow. Electricity can flow either direction when the channel is open, and the source designates the region where the current flows into the transistor. Thus the n-doped region on the left in Figure 3 can be the source at one point in time, or the drain at a later point. The bi-directional nature of FETs makes them more versatile than BJTs.

A simpler, modified version of the FET, known as the junction field effect transistor (JFET) uses the same principle described above, except the gate closes off a conducting channel instead of opening one. In the design of a JFET, shown in the figure below the source and drain regions are not separated and, instead, are merely part of the bulk. The bulk region is made up of a doped semiconductor with a very narrow section, and the gate is merely a region of oppositely doped material next to the narrow section of the bulk. The gate is controlled by a voltage that, when increased, attracts the doped charge carriers in the narrow section of the bulk to the gate region, effectively pulling them out of the bulk and creating a charge depletion region that stops electrons from flowing through the bulk.

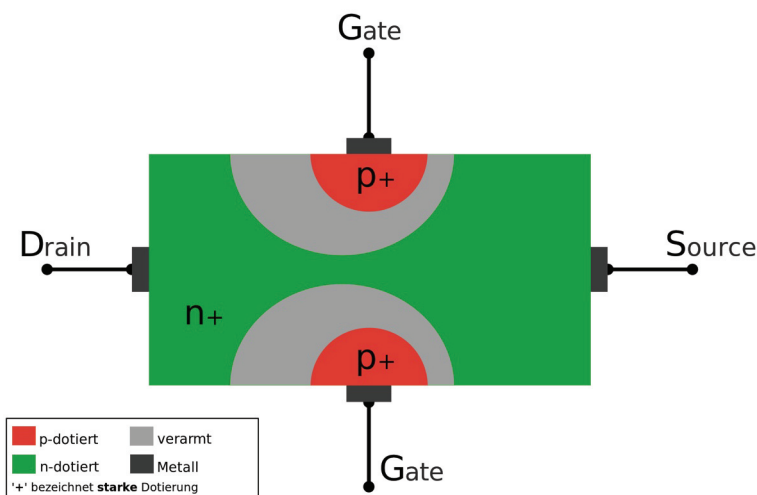

Scheme of n-junction field-effect transistor de/ Norro

No transistor works perfectly, meaning that the flow of electricity across the bulk or charge depletion region (CDR) can never be stopped completely, or open to the point of causing zero resistance. Furthermore, switching the base from closed to open requires that carriers be injected into or removed from it, and opening up the CDR requires that electrons travel through the bulk to that region, which does not happen instantaneously. Research in transistor technology seeks not only to make the transistors physically smaller, but also to improve how well the base can insulate in the "closed" state, how well it can conduct in the "open" state, and how reliably and quickly it can switch between those states.

Transistors perform different functions, such as gates or amplifiers, and their specific functions are controlled by many different design parameters. Therefore it is important not only to understand how transistors function, but the different parts they play in system-level applications. There are entire books written on this topic; to illustrate it, let's use the communications system in an unmanned aerial vehicle (UAV) as an example.

A drone's first step in communicating with its pilot is receiving the control signal. This signal has been sent from some distance away and the signal strength is usually relatively small; also, the control signal is embedded in the surrounding "noise" of electromagnetic waves of many different frequencies from many other sources. Inductors and capacitors are used to isolate a single desired frequency from the cacophony the UAV antenna picks up. If any of those components deteriorates significantly, then the antenna won't be able to isolate the intended frequency, and therefore won't even receive the communication from the pilot. Assume for the purpose that there has been no degradation, and the control signal is successfully detected. That signal will first be amplified, most likely by serving as the controlling voltage for a larger current running through a BJT. Once the signal has been boosted, it must be converted from an analog wave to a digital signal of ones and zeros, a process that heavily employs transistors and diodes. Failure at this step compromises the communications packet.

If the instructions from the pilot are successfully received, amplified, and converted, the digital signal must then be analyzed by the drone's onboard computer. By far the most common use of transistors is as logic gates, which are the basic building blocks of processor chips. Metal Oxide Semiconductor Field Effect Transistors (MOSFETs) are most frequently used for this function. When any computer analysis job is performed, current flows through a series of logic gates, and the specific computations determine which gates are open and which are closed, which controls where the electrical current flows and thus the outcome the computer reaches. When a transistor inside a chip fails, that can affect one type of calculation or many, depending on where the transistor is placed and its role in the computation. A transistor failure could cause a slight miscalculation in the instructions received, or a complete failure of the communications system in the drone to interpret the pilot's instructions. The results of the instructions control the components (e.g., motors that control the flight surfaces, or weapons release controls) within the drone. These components also include microelectronics that are involved in carrying out the instructions. So even if the central computer functions properly and can communicate with its pilot, failures of the electronics in the motors that steer the drone or release its payload could have catastrophic results. Therefore the specific use of the transistor, in addition to its design, determines the nature of failures that might happen.

Fundamentally, an AEC-induced fault in a single micro component such as a transistor could result in a macro system failure. As we have already said, as the components in microelectronics become smaller, single or a few atomic effects could lead to that component failure. The future of microelectronics is nanoelectronics. Components of electronic circuits are going to continue to decrease in size, and future DoD systems are going to incorporate new electronic systems composed of nanomaterials that will be extremely susceptible to the impacts of AEC. The basic principles that govern the components (i.e., diodes, transistors, etc.) of current microelectronics will continue to be used in the nanoelectronic components of the future. As the DoD acquires future systems, a complete material sustainment strategy needs to consider how AEC can lead to failures in DoD systems due to changes in the underlying atomic properties of microelectronic components, as well as other “traditional” forms of corrosion.

### *Degradation of Microelectronics By AEC*

In this section, we present a more detailed discussion than that in chapter 2 regarding single event effects in microelectronics caused by AEC. These effects represent the “direct” types of damage that can be caused by AEC: that is, AEC that can lead to component failures. Following this description, we provide an example of how AEC in

**AEC can lead to component failures.**

a microelectronic circuit can catalyze degradation of that circuit, as well as showing how failure to consider such impacts can impair the ability to predict material failure with accuracy. These degradation events represent how “indirect” damage can also occur in microelectronics due to AEC, and these effects can become the catalysts for classical degradation.

### *Single Event Effects in Microelectronics*

Currently, the main concern with radiation effects on microelectronics relates to “single event effects” (SEEs). These include single-event upsets (SEUs) wherein a bit within the microcircuit is changed from its correct value. In a memory chip, this can change the stored value. Multi-bit upsets are also possible, wherein a set of bits are changed. For the most part, SEEs are “soft errors,” meaning that the damage is limited to the error, and that any permanent damage is insignificant and inconsequential. It is however possible, for a SEE to cause a “hard error,” wherein some part of the microcircuit is permanently damaged. For example, a “single event latchup” (SEL) can, in some instances, cause high currents that damage channels or junctions to cause a hard error. Single-event upsets (SEUs) are particularly problematic for SRAM Field Programmable Gate Arrays (FPGAs), and are becoming more significant as geometries continue to get smaller.<sup>14</sup> A change to the stored bit stream that programs the FPGA can cause a program error, which might cause a failure upon execution. Whether a soft or hard error, radiation-caused events typically cause a degradation of the microelectronic device.

---

14. Dr. Keith E. Holbert, “Single Event Effects,” *Arizona State University*, 18 Jan 2006, Accessed 7 Oct 2015, <http://holbert.faculty.asu.edu/eee560/see.html>.

Most of the consequences of single-event effects are due to ionization tracks from charged particles that are emitted due to a nuclear event within the chip. These events are instigated by external radiation with a source typically from one of the following:

- A galactic cosmic ray that has made it through the atmosphere to arrive at the terrestrial level to interact with the microelectronic device, or a byproduct of a cosmic ray in a cascade event in the atmosphere. The particles of significance are generally neutrons.<sup>15</sup>
- Alpha particles emitted as radiation from a contaminating source in close proximity to the semiconductor. These can originate from uranium or thorium contaminants in packaging material, from an alpha emitter such as a byproduct of a lead isotope in solder, or an alpha particle cosmic ray.
- A decay product from an isotopic transmutation that has taken place by virtue of the absorption of a neutron within the active layers of the microcircuit (i.e., neutron activation within the microchip). For example, absorption of a cosmic neutron in an elastic collision with a silicon atom nucleus.
- Neutrons produced by radioactive materials or other sources of nuclear particles. Neutrons will pass through many materials, so special shielding is often required, and the shielding material can subsequently cause secondary emissions.

SEEs are typically instigated by linear energy transfer (LET), which is categorized according to a measure of energy deposited in a material. High-LET radiation is generally caused by protons, neutrons, or alpha particles. Low-LET radiation comes from photons (including X-rays and gamma rays), electrons, positrons and muons.<sup>16</sup> In either case, energy is transferred to create a shower of ion charges deposited into the microelectronics material, creating electron-hole pairs, some of which can be trapped and change the properties of the electrical components such as diodes, capacitors, and transistors. At sufficient energy levels, transients in microelectronics at reverse bias junctions can cause irreparable damage. Exceeding the peak reverse bias on a diode can cause breakdown, which is why static discharges are avoided with microelectronics. Both high and low LET events can cause problems as gate sizes in transistors become extremely fine.

Traditionally, the reliability of microelectronics is measured in Failures in Time (FIT). One FIT is equivalent to one error (hard or soft) per 10<sup>9</sup> hours (one billion hours) of operation. Soft error rates in microchips can vary from a few hundred to many thousands of FITs.<sup>17</sup> At 100,000 FIT, one can expect roughly one error per year of continuous operation. Hard error rates are expected to be less than 10 FIT. For SRAM memory chips with gigabit capacities, soft error rates of 50,000 FIT are typical, according to one source.<sup>18</sup> For most consumer applications, this is not a significant problem, especially given that most consumers replace their computers, cell phones and other devices every few years.

---

15. "Measurement and Reporting of Alpha Particle and Terrestrial Cosmic Ray-Induced Soft Errors in Semiconductor Devices," *JEDEC Solid State Technology Association* (Arlington, VA) 2001.

16. Claude Leroy and Pier-Giorgio Rancoita, *Principles of Radiation Interaction in Matter and Detection* (World Scientific, Sep 2011).

17. Santosh Kumar, Shalu Agarwal, and Jae Pil Jung, "Soft Error Issue and Importance of Low Alpha Solders for Microelectronics Packaging," *Rev. Advanced Materials Science* 34 (2013): 185-202.

18. *Ibid.*

For certain DoD applications, this could be problematic, both due to their operating environments and the extended life cycles we expect from military systems. For example, aircraft flying at an altitude of 30,000 feet or higher are subject to neutron densities hundreds of times higher than at sea level. One can expect FIT rates for soft errors to increase proportionately. For hard errors, greater scaling is possible as multiple events in proximity within a microchip might compound problems, causing a degradation that eventually results in failure. Much research relates to NASA and DoD satellite systems, where it is understood that microelectronic components are subject to various kinds of radiation effects, both within the earth's atmosphere and outer space. For NASA, a single event upset (SEU) is defined as "radiation-induced error in microelectronic circuits caused when charged particles (usually from the radiation belts or from cosmic rays) lose energy by ionizing the medium through which they pass, leaving behind a wake of electron-hole pairs."<sup>19</sup> As such, a SEU is typically a soft or recoverable problem, but can also cause degradation of the material. When an SEE causes a hard error, it is clearly a degradation event. In space electronics, SEUs are caused by galactic cosmic rays, cosmic solar particles, and are often heavily influenced by solar flares or protons trapped in radiation belts. There are various other kinds of single damage events including single event transients (SETs), single event latchups (SELs) and single event burnouts (SEBs). Cumulative damage is also possible due to repeated ionizing events that overlap in critical areas.

In terrestrial applications, the radiation of consequence is most likely to be neutron events from cosmic rays and nearby radiation sources, and alpha particles from nearby materials. These events may be rare, but can cause upsets and reliability problems, and might become more consequential in new forms of microelectronics. Similarly, electronics confined to the earth's surface in close proximity to high neutron fluxes can experience higher rates of SEEs, and potentially greater rates of hard errors, including degradation-induced failure. For example, electronics embedded deep within a nuclear power plant might be well-shielded from gamma radiation, but still experience high neutron flux density.

U.S. industries are developing microchips with increasing numbers of nanometer-sized components, yet we counter that advantage by having to use "brute force" design techniques such as incorporating multiple redundancies into those chips so that if one component fails, a backup component is available to pick up its function. This design also introduces additional computational (processing) requirements to check whether or not

**U.S. industries are developing microchips with increasing numbers of nanometer-sized components.**

the primary component has failed so a backup needs to take over. If, however, we can understand the *specific mechanisms* of AEC degradation and their implications on nanotechnology systems, then we may be able to devise other ways to overcome these AEC effects. As a result, we may no longer need to resort to building in redundancies, or may at least be able to reduce redundancies. This is one motivation behind addressing AEC as a degradation/corrosion mechanism – and

19. Claude Leroy and Pier-Giorgio Rancoita, *Principles of Radiation Interaction in Matter and Detection* (World Scientific, Sep 2011).



it is why this non-classical degradation phenomenology is important to understand in order to promote improved material sustainment policies.

### *AEC Catalyzed Electromigration in Microelectronics*

The DoD has many assets that critically rely on microelectronics and thus identifying the various phenomena that can cause degradation in these systems is essential for proper material sustainment strategies. The goal of material sustainment is to ensure that acquired systems last for their expected lifetimes, require minimum maintenance, and remain reliable.

In order for the DoD to properly manage their systems to maximize their life cycles a thorough understanding of the effects that lead to their degradation is needed. In systems that critically depend on microelectronics to operate it is important to understand the various chemical and physical phenomena that can lead to their degradation. An area of degradation effects that is receiving more attention as the line widths between electronic interconnects approaches single digit nanometers is material migration.<sup>20,21,22</sup> Material migration can refer to metal atoms/ions diffusing due to chemical or temperature gradients; as a result of mechanical stress; or as a result of an interaction with an applied electric field.

The migration of materials due to an applied electric field is also referred to as electromigration. Of the different mechanisms by which atoms in material materials can migrate, electromigration is likely the most influenced by interactions of materials with radiation (i.e., AEC). In an electrical circuit, the interconnects are typically made of a conducting metal such as Cu or Al and these are polycrystalline structures constructed of grains that are identical in their lattice structures, but arranged in different orientations (see the figure below).<sup>23</sup>

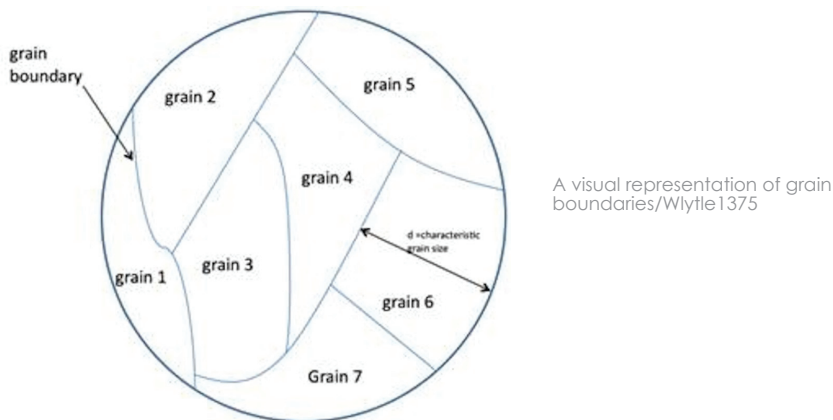

20. Jens Lienig, "An Introduction to Electromigration-Aware Physical Design" Proc. Of the Int'l Symposium on Physical Design, *Dresden University of Technology* (Dresden, Germany: 2006).
21. Hirokazu Tanaka, "Factors leading to ionic migration in lead-free solder" *ESPEC Technology Report*, No. 14 (Jan 2007).
22. Shigeharu Yamamoto, "How impurities affect ionic migration, and how to counter their impact" *ESPEC Technology Report*, No. 22 (1 Sept 2006).
23. Lienig, J. (2006), "An Introduction to Electromigration-Aware Physical Design" Proc. Of the Int'l Symposium on Physical Design I.

The consequence of this arrangement is that the areas where two grains touch (grain boundaries) represent a weakness in the entire polycrystalline structure because the metal atoms/ions at these edges are more weakly bound to the grain. As a result, these edge atoms/ions are susceptible to migration across the grain boundary when exposed to an appropriate force.

In microelectronics, the force that facilitates electromigration is caused by current flowing through the interconnects. The current is the flow of electrons moving through the conductive material, much like water that flows through a riverbed. This flow of electrons creates two forces that can act upon the metal ions/atoms, especially those at the grain boundaries, and dislodge them from or the change their orientation in their lattice structure. The first force is the force from the applied electric field ( $F_{\text{field}}$ ) in the interconnect and the second force is caused when the electrons flowing through the conducting metal transfer some of their momentum to the metal ions/atoms in the polycrystalline lattice ( $F_{\text{wind}}$ ). This force is commonly referred to as the "electron wind" and is typically the major force behind electromigration.<sup>24</sup>

When the force of the electron wind reaches a particular threshold, metal ions/atoms at the grain boundaries will begin to migrate in the direction of that force and typically in the direction of the grain boundary as well. Overtime, the migration of metal ions/atoms from the grain boundaries can lead to two types of formations that can facilitate the failure of the circuit known as hillocks and voids.

Hillocks are protrusions out from the surface of the crystal lattice that can cause shorts between adjacent interconnects and voids are holes within the polycrystalline lattice that reduce the current flow, increase current density, and eventually lead to interconnect failure (interconnect no longer conducts).

The likelihood an electronic interconnects will fail due to the accumulation of voids and/or hillocks is somewhat calculable thanks to the work of J.R. Black who developed a model to estimate the mean time to failure (MTTF) of a wire.<sup>25</sup> The equation derived from his work predicts the half life of a wire and is given as:

$$MTTF = \frac{A}{J^n} * \exp\left(\frac{E_A}{k \cdot T}\right)$$

where A is a constant derived from the cross-sectional area of the wire (units?), J is the current density (units?), n is a scaling factor determined to be 2 by Black,  $E_A$  is the activation energy needed to dislodge a metal ion/atom at the grain boundary in Joules, k is

24. Lienig, J. (2006), "An Introduction to Electromigration-Aware Physical Design" Proc. Of the Int'l Symposium on Physical Design I

25. James R. Black, "Electromigration - A Brief Survey and Some Recent Results," *IEEE Transaction on Electron Devices* 16, No. 4 (April 1969): 338-347.

the Boltzman constant ( $1.38 \times 10^{-23}$  J/K) and T is the temperature in Kelvin. From looking at this equation it should be obvious that current density and the temperature of the wire are major factors in the MTF.

The Black's equation allows one to predict the lifetime of a particular circuit design with respect to failure from electromigration. The output of this equation is affected by many of the design choices for a particular circuit such as: the wire material, the wire temperature, the wire size and metal slotting, the wire length, the via arrangements and corner bends, and the terminal connections. What is also evident from this equation is that additional energy added to the system in the form of radiation can also accelerate the degradation processes due to electromigration.

When radiation penetrates microelectronics they can interact with the environment and material in a number of ways (many which have been described extensively throughout this book). The exact nature of the interaction will depend on the type of radiation as particulate radiation, such as neutrons, and electromagnetic radiation, such as gamma photons, will cause different effects. The impact of particulate radiation can weaken the strength of the crystal lattice lowering the required energy needed to force a metal atom/ion at the grain boundary to migrate. Electromagnetic radiation can facilitate the Compton effect (and effects like it) that disrupt the flow of electrons leading to potential changes in the properties of the interconnect and could even increase the affect of the electron wind. The overall conclusion here is that the AEC caused by radiation can decrease the MTF by accelerating the forces that lead to the degradation of the function of circuit interconnects. Most important is that ***the MTF equation does not contain a term that incorporates the frequency or magnitude of radiation events, and therefore the Black equation underestimates degradation impact in environments where materials are subjected to those phenomena that cause AEC.***

Despite this limitation, people and organizations are trying to bring awareness to the important reality that future microelectronics designs are going to suffer more from degradation events such as electromigration. Strategies are being developed in an attempt to mitigate these effects in the design stage. One such proposal, referred to as the electromigration-aware physical design flow, has already been implemented and verified in a commercial design for analog and mixed signal integrated circuits for automotive applications.<sup>26,27</sup> While plans such as this are the important steps in material sustainment strategies, the current plans fail to address the role AEC plays in accelerating degradation events such as electromigration. More research into the exact role AEC induced by radiation needs to be performed in order to increase the predictive power of equations such as Black's equation and lead to better design strategies to

**Strategies  
for material  
sustainment  
need to include  
bottom-up  
models that  
include AEC.**

26. G. Jerke, and J. Lienig, "Hierarchical current-density verification in arbitrarily shaped metallization patterns of analog circuits," *IEE Transactions on Computer-Aided Design of Integrate Circuits and Systems* 23, No. 1 (Jan 2004): 80-90.
27. G. Jerke and J. Lienig, "Reliability-driven layout decompaction for electromigration failure avoidance in complex mixed-signal IC designs," *Proc. Design Automation Conf* (2004): 181-184.

mitigate the degradation events that will become more common in microelectronics as electronic components such as transistors and line widths between interconnects continue to get smaller.

### *Planning the Future for AEC in Microelectronics*

As the Services continue to rely on microelectronics in their assets, and develop new systems that incorporate more state-of-the-art microelectronics, strategies for material sustainment will need to include "bottom-up" models that describe how materials degradation can occur through phenomena that cause AEC. As mentioned many times before in this book, the goal of material sustainment is material reliability throughout the material's life cycle. When the materials are the components of microelectronics systems, a precise understanding of the atomic properties of each material and how the environment can manipulate and change these properties is needed. The CPO is currently charged with ensuring material sustainment strategies aimed at preventing and controlling the degradation of DoD materials. Therefore, the CPO's corrosion prevention and control strategies that are core to their material sustainment approach need to incorporate the ways that materials such as those used in critical microelectronics systems can degrade due to AEC.

To date, there is insufficient understanding of how the properties of microelectronic materials change throughout their life cycle due to interactions with their environment. The microelectronics that will be built into future military avionics or other equipment will need to be understood from the bottom-up in order to ensure low failure rates can be designed into future systems, particularly as the importance of AEC increases with decreasing microelectronic feature sizes. Currently, high-volume (and thus low cost) microelectronics are developed for commercial applications, which have expected 3-7 year lifetimes.<sup>28</sup> The requirements of most military assets containing microelectronics exceed these expected commercial lifetimes by factors of 3-10. Consequently, the DoD needs well-developed material sustainment strategies to ensure that microelectronics-dependent systems will continue to function reliably during their DoD life cycles. This strategy has to consider how the phenomena that cause AEC in microelectronics can impact the reliability of those microelectronics.

A major step towards this type of strategy was made in 1994 when then Secretary of Defense William Perry issued a memorandum that stopped the use of MIL-HDBK-217 series, which was the military handbook used for reliability prediction of electronic equipment.<sup>29</sup> This handbook utilized several different exponential models known as constant failure rate (CFR) models to explain when microelectronic components would fail. In the 1990s it became increasingly clear that the CFR models were unable to explain the unique ways complex IC designs were failing, and the "Perry Memo" was the response. In addition to

- 
28. Mark White and Joseph B. Bernstein, "Microelectronics Reliability: Physics-of-Failure Based Modeling and Lifetime Evaluation," *Jet Propulsion Laboratory* (California Institute of Technology, CA: Feb 2008).
  29. Office of the Secretary of Defense, William J. Perry, *Memorandum for Secretaries of the Military Departments* (Washington, D.C.: 29 June 1994), <http://sw-eng.falls-church.va.us/perry94.html>

eliminating the use of the MIL-HDB-217 series, Secretary Perry's memo encouraged the DoD to adopt industry standards for quality assurance of microelectronics.

Much of industry uses what is known as a physics-of-failure approach when it comes to reliability modeling for microelectronics components.<sup>30</sup> This approach attempts to understand the physics of failure (i.e., a bottom-up approach) that requires understanding how materials degradation leads to failure at the atomic scale. The CFR approach did not incorporate physical mechanisms because it modeled failure as a mathematical distribution wherein failures were due to random chance. Furthermore, these models failed to account for how multiple initiating events could eventually lead to failure; the CFR approach assumes microelectronic components only fail because of a single type of failure. The physics-of-failure approach considers all potential failure mechanisms that are chemical, electrical, physical, mechanical, structural, or thermal in nature. In doing this, a mathematical model founded in the physical structure of the material at the smallest possible scale is created through experimentation and computational modeling. The ultimate output of this approach is an equation for the dominant failure mechanism of the microelectronic system and its mean-time-to-failure (MTTF). Physics-of-failure approaches include models such as Black's equation discussed in the previous section. As discussed there, these models clearly have room for improvement to incorporate the impact of AEC on materials degradation in microelectronics.

Even though there are now better models that can be incorporated into material sustainment strategies for microelectronics, many engineers still rely on MIL-HDBK-217 when they go about designing new microelectronic circuits.<sup>31</sup> Planning for the impact of AEC on microelectronic components is not a new concept or idea. Both NASA and DMEA are aware of the importance of physics-of-failure models in assessing microelectronics reliability. Both organizations have been engaged in efforts to ensure that microelectronics acquired by NASA or the DoD are resistant to the impacts of AEC.

The CPO can coordinate the research needed to expand these excellent efforts, with the goal of ensuring that bottom-up predictive models are being employed and developed assess all possible microelectronic failures due to AEC. This means coordinating material sustainment strategies for microelectronics with NASA and DMEA (and others working in similar areas) to ensure that the most bottom-up predictive models, founded in the laws of physics and represented at the smallest scale possible, are being used by the Services as they consider the life cycles of existing and future microelectronic components.

**The  
CPO can  
coordinate  
the  
needed  
research**

30. Mark White and Joseph B. Bernstein, "Microelectronics Reliability: Physics-of-Failure Based Modeling and Lifetime Evaluation," *Jet Propulsion Laboratory* (California Institute of Technology, CA: Feb 2008).

31. *Ibid.*

## INDIRECT AEC DAMAGE: LOSS OF CAPABILITY IN NUCLEAR REACTOR MATERIAL PROPERTIES ON NAVY SUBMARINES THROUGH LATTICE DEFECTS

The purpose of this section is to provide a specific example of the impact atomic effects corrosion can have on a military platform that is critical to our national security. Navy nuclear submarines (SSNs, guided missile submarines – SSGNs, and ballistic missile submarines – SSBNs) use nuclear power to operate, and their materials, particularly in the vicinity of reactors, are exposed to highly irradiative environments. This exposure leads to materials experiencing atomic effects corrosion. For these materials, the atomic effects can start as nucleating or catalyzing events at the nanoscale that eventually lead to macroscopic property failure and the need to replace or decommission the nuclear reactor.<sup>32</sup>

In the near future, the Navy intends to replace its current Ohio-class (SSBN/SSGN) nuclear powered submarines.<sup>33</sup> By combining both science and empirical exploration into nuclear operations, the Navy has maintained an excellent historical track record of safety, reliability, and superior capability relative to other nations' nuclear submarine programs. The Ohio-class replacement program offers the opportunity to design the next nuclear submarine from the “atom up” – a science-based, bottom-up approach to reactor selection and design that considers all associated reactor materials and potentially new reactor types. For example, the pressurized water reactors of the past were selected without knowledge of how materials in nuclear reactor environments degrade at the atomic scale. This knowledge is now available and can be incorporated into the design for the Navy's new SSBN(X). The Navy has in the past demonstrated an ability to lead in the nuclear energy area<sup>34</sup> and their choices with the SSBN(X) will have an impact on the future of nuclear energy. The Navy can, therefore, use this opportunity to set a precedent in designing future nuclear reactors to withstand and mitigate the impacts of AEC.

The description below overviews and highlights the historical use of pressurized water reactors in Navy submarines. Then, we discuss the material properties of these reactors, how they degrade through AEC, and how the Navy can use this information to better mitigate and plan for the impact of AEC as they replace the Ohio-class ballistic missile submarine.

---

32. C.R.F. Azevedo, “A Review of Neutron-Irradiation- Induced Hardening of Metallic Components,” *Engineering Failure Analysis* 18, No. 8 (Dec 2011): 1921-1942.

33. Stew Magnuson, “Nuclear Power Plants on New Submarines May Last 40-Plus Years,” *National Defense Magazine*, Feb 2015, <http://www.nationaldefensemagazine.org/archive/2015/February/Pages/NuclearPowerPlantson-NewSubmarinesMayLast40PlusYears.aspx>.

34. “Nuclear Reactor Design Chosen – Not Because It Was Safe – But Because It Worked on Navy Submarines,” *Washingtons Blog*, 20 June 2011, <http://www.washingtonsblog.com/2011/06/nuclear-reactor-design-chosen-not-because-it-was-safe-but-because-it-worked-on-navy-submarines.html>.

## History of Nuclear Reactors in Military

The United States Navy has been using nuclear propulsion in their submarines since the 1950s.<sup>35</sup> Unlike their diesel counterparts, which required frequent surfacing (or near-surfacing if they used snorkels) to charge the batteries used for propulsion while submersed, nuclear powered submarines can remain submersed for extended periods. The ability to remain submersed was a huge advantage because it meant the Navy could avoid exposing submarines on or near the surface. Admiral Hyman Rickover led the development of Naval nuclear power, including submarines, for over three decades;<sup>36</sup> during the initial development, he had several options to choose from as different laboratories were working on prototype reactors that used different materials, different designs, and different fuel sources.<sup>37</sup> Admiral Rickover settled on a prototype built by the Westinghouse Electric Corporation that used a uranium fuel cycle in a pressurized light water reactor vessel called the Submarine Thermal Reactor. This prototype was developed into the S1W reactor that was used in the first Navy submarine, the USS *Nautilus*.<sup>38</sup> Admiral Rickover's choice of pressurized water reactors with a uranium fuel cycle was likely based on two things: (a) the desire to use a fuel cycle that produced plutonium as a decay product that could be purified to create nuclear weapons, and (b) the fact the pressurized water reactor prototype met the size, safety, performance, and weight requirements for Navy submarines.<sup>39</sup>

Admiral Rickover's decision had a profound impact on the future of nuclear energy within the United States as well as globally. At the time, no standards existed regarding the types of nuclear reactor to be employed for either land or sea based nuclear power. Multiple laboratories were working on different reactor types such as liquid metal reactors,<sup>40</sup> molten salt reactors,<sup>41</sup> and pressurized water reactors.<sup>42</sup> Most of these reactors used uranium-based fuel cycles, but others used a fuel cycle based on thorium. Different fuel cycles create different decay products, which cause different mechanisms for degradation within the materials that contain these nuclear reactions. Admiral Rickover's choice gave pressurized water reactors government backing, and as their advantages became apparent it was extremely difficult for alternative reactors and fuels to break into the nuclear energy market.<sup>43</sup> This choice also highlights the im-

- 
35. "Nuclear-Powered Ships," *World Nuclear Association*, Modified Aug 2015, Accessed 22 Sept 2015, <http://www.world-nuclear.org/info/Non-Power-Nuclear-Applications/Transport/Nuclear-Powered-Ships/>.
  36. "Hyman G. Rickover," *Wikipedia*, Modified 20 Sept 2015, Accessed 24 Sept 2015, [https://en.wikipedia.org/wiki/Hyman\\_G.\\_Rickover](https://en.wikipedia.org/wiki/Hyman_G._Rickover).
  37. M. Ragheb, "Nuclear Marine Propulsion," *Rensselaer Polytechnic Institute*, 14 April 2015, <http://mragheb.com/NPRE%20402%20ME%20405%20Nuclear%20Power%20Engineering/Nuclear%20Marine%20Propulsion.pdf>.
  38. "Nuclear Propulsion," *FAS.org*, Modified 29 Feb 2000, Accessed 26 Sept 2015, <http://fas.org/man/dod-101/sys/ship/eng/reactor.html>.
  39. "Nuclear Reactor Design Chosen – Not Because It Was Safe – But Because It Worked on Navy Submarines," *Washingtons Blog*, 20 June 2011.
  40. Office of Technology Assessment, *Technical Options for the Advanced Liquid Metal Reactor* (Washington, D.C.: U.S. Government Printing Office, May 1994).
  41. "Thorium-Fuelled Molten Salt Reactors," *The Weinberg Foundation*, June 2013, <http://www.the-weinberg-foundation.org/wp-content/uploads/2013/06/Thorium-Fuelled-Molten-Salt-Reactors-Weinberg-Foundation.pdf>.
  42. Office of Nuclear Energy, Science and Technology, *This History of Nuclear Energy* (Washington, D.C.: U.S. Department of Energy).
  43. "Nuclear Reactor Design Chosen – Not Because It Was Safe – But Because It Worked on Navy Submarines," *Washingtons Blog*, 20 June 2011,

pact decisions the U.S. Military makes can have on civilian and commercial markets in terms of technology adoption.

Pressurized water reactors utilizing a uranium fuel cycle are still the main reactor design for the Navy's nuclear submarine program. As of 2014, the U.S. Navy operates 75 submarines that are powered using pressurized water reactors. Decades of experience in multiple reactors offer the opportunity to leverage the science associated with their materials degradation in new designs. Understanding how the materials used to build these reactors degrade at the atomic scale due to atomic effects corrosion can lead to better predictive models of reliability and safety. The next sections describe these reactors and explore some of the AEC mechanisms and their effects.

### *Pressurized Water Reactors*

It was clear from the beginning that pressurized water reactors (PWR) were going to require unique material properties to deal with the harsh environments in which they operated. For example, it was quickly realized that the materials of the Submarine Thermal Reactor (STR) were sensitive to classical corrosion caused by

**Pressurized water reactors are still the main reactor design for Navy nuclear submarines.**

the extremely hot water reacting with the metal cladding that surrounded the fuel.<sup>44</sup> From empirical studies, the first solution used zirconium for the cladding because it resisted these classical corrosion effects. A more sophisticated understanding of the mechanism causing this degradation led to the development of better materials for the cladding like Zircaloy, a zirconium alloy that has better performance than its pure zirconium predecessor.

Most Naval nuclear submarines contain a miniaturized version of the land-based pressurized water reactor (PWR) types used to provide commercial electrical power in the United States.<sup>45</sup> These naval reactors differ in several ways from their land-based counterparts. Land-based PWRs are much larger, produce more power, and use a less-enriched uranium fuel source made of uranium dioxide. Despite these differences, both the naval and land-based PWRs use the same principles to produce power.

Naval PWRs deliver a lot of energy from a very small volume of fuel. This fuel is made of highly-enriched uranium (93% U-235) alloyed with either zirconium or aluminum.<sup>46</sup> This combination helps provide long core lives, and the reactors only need to be refueled after a decade or more of use. These cores are designed to last between 30-40 years. The long core life is due to the purity of the fuel and the introduction of "burnable poison particles" (BPPs) such as boron, which reacts with fission products as the fuel is used up; the BPPs compensate for reactivity loss as the fuel is consumed, and thereby provide a means of long-term reactivity control.<sup>47</sup>

44. M. Ragheb, "Nuclear Marine Propulsion," *Rensselaer Polytechnic Institute*, 14 April 2015.

45. M.F. Ashby and Michael Smidman, "Materials for Nuclear Power Systems," *GRANTA Material Inspiration* (January 2010), <http://www.grantadesign.com/download/pdf/nuclear.pdf>.

46. "Nuclear- Powered Ships," *World Nuclear Association*, Modified Aug 2015, Accessed 22 Sept 2015, <http://www.world-nuclear.org/info/Non-Power-Nuclear-Applications/Transport/Nuclear-Powered-Ships/>.

47. J.L. Kloosterman, "Application of boron and gadolinium burnable poison particles in UO<sub>2</sub> and PUO<sub>2</sub> fuels in HTRs," *Annals of Nuclear Energy* 30 (2003): 1807-1819.



A schematic of a pressurized reactor plant schematic is shown in the figure below. The system consists of high-strength steel reactor vessel encased with shielding material, a heat exchanger, a primary coolant system, a secondary coolant system, and the associated piping, pumps, and valves. The pressurized flow within the coolant system allows the water to extract heat from the core, and maintaining a constant flow prevents the water from boiling. This pressurized flow allows the water to act as both a coolant and neutron moderator.<sup>48</sup> As the water passes through the heat exchanger steam is generated, which is pumped through the secondary system in order to drive the turbines that propel the submarine. The steam then condenses back into water where it is fed back to the steam generators.

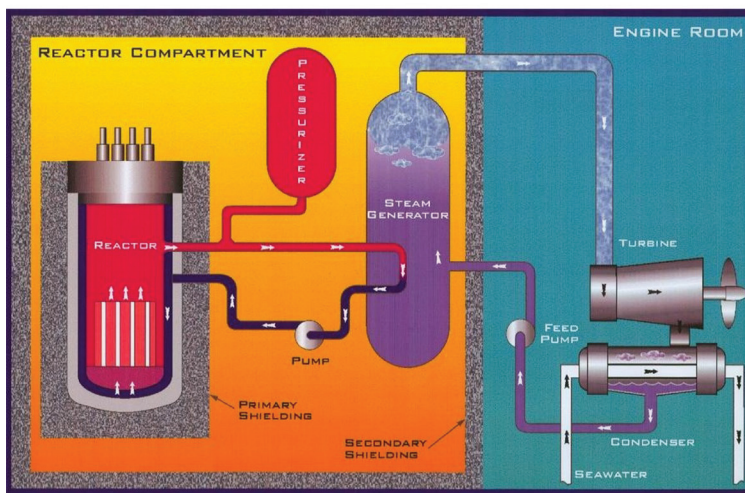

Reactor Plant Schematic/NNSA/DoE

The PWRs for all Naval submarines are housed in a central location within the submarine known as the reactor compartment (see figure page 162). The reactor compartment is cylindrical in shape and contains two shielded bulkheads at each end. The Ohio Class submarine reactor compartment, for example, is a large cylinder approximately 55-ft long, 42-ft in diameter and weighs roughly 2750 tons.<sup>49</sup> The internal components of these reactors are not typically accessible during the life cycle of the core. The reactors must be able to withstand the extreme operating conditions at sea, plus the harsh internal environment characteristic of all PWRs. As a result, the PWRs' material components experience the long-term effects of radiation, classical corrosion, and mechanical stresses caused by high temperatures and pressures and temperature/pressure changes.

48. Massoud T. Simnad, "Nuclear Reactor Materials and Fuels," *University of California, San Diego*, 1992, <http://www.cryptocomb.org/Nuclear%20Reactor%20Materials%20and%20Fuels.pdf>.

49. "Nuclear Propulsion," *FAS.org*, Modified 29 Feb 2000, Accessed 7 Oct 2015, <http://fas.org/man/dod-101/sys/ship/eng/reactor.html>.

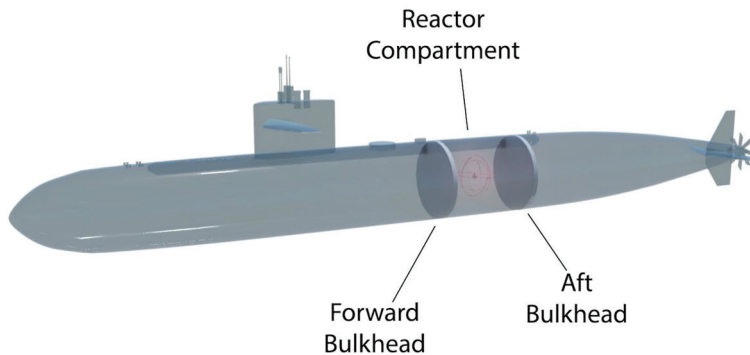

Typical nuclear submarine reactor compartment location/Alex Taliesen

PWRs are constructed from a variety of different metals and ceramics, all designed to have specific mechanical properties critical for the PWR to operate reliably and safely. The important components of a PWR from a material sustainment standpoint are the control rods, the pressure vessel, and the piping/internal components. The control rods are typically made of boron carbide or a gold-indium-cadmium alloy. These rods are typically clad in stainless steel tubes. The pressure vessel is made of steel, and most pressure vessels are encased in Zircaloy cladding. The piping and internals, as well as the steam generators, are constructed from stainless steels. All of these different metal alloys were selected **based on their intended use and desired mechanical properties** because the science to address their vulnerabilities to AEC did not exist.<sup>50</sup> That is, the bottom-up science had yet to be seriously addressed. With recent scientific advancements, however, this is no longer the case. Any good materials engineer would agree that materials selection should be based on both desirable mechanical properties *and* their ability to function for the design lifetime. Now that the underpinning science exists to address not only materials' mechanical properties but also material sustainment, it has become possible to develop design strategies that ensure important PWR components not only have superior mechanical properties, but also are resistant to the impacts of AEC (as well as other forms of corrosion).

Degradation due to AEC in PWRs on Navy submarines can lead to a variety of failures. For example, AEC degradation can lead to the fracture of a metal alloy. A crack in the reaction vessel could lead to leakage of nuclear material, and potentially force shutdown. Mechanical failures in either of the coolant systems can lead to the PWR operating at temperatures that promote further degradation of the reactor from classic corrosion or mechanical stresses, or could lead to lower efficiencies in converting the heat of the nuclear reaction into propulsive force for the submarine's propeller. Therefore, the primary materials of concern for AEC in PWRs are the metal alloys from which they are constructed. Because radiation-induced AEC contributes to materials degradation in nuclear reactors, a better understanding of degradation mechanisms at the atomic scale can help improve both selection of materials and reactor designs.

50. Marquis A. Emmanuelle, "Nuclear reactor materials at the atomic scale," *Materials today* 12, No. 11 (2009): 30-37.

## AEC Mechanisms in Nuclear Reactors

Having introduced the impact of AEC in the section above, we now turn to a more detailed description of examples of AEC mechanisms. As stated earlier, a PWR reactor utilizes water as a coolant and thus its internal piping is subject to the classical corrosion mechanisms associated with water interacting with materials. In addition, the reactor core functions through the fission of U-235, and this process releases energy in the form of heat, radiation; and fast, intermediate, and thermal neutrons.<sup>51</sup> Most nuclear reactors on land operate at a steady state, meaning they operate at the same level, and produce the same amount of power, over a 24-hr period.<sup>52</sup> Naval reactors do not operate like land reactors because the demands of the submarine fluctuate as the submarine changes depth, direction, and speed. To meet these demands, the reactor core must operate at different levels, which changes the rates at which it produces heat and radiation. As a result, the materials within the PWR will experience a range of temperatures, pressures, radiation levels and neutron fluxes (see the figure below).<sup>53</sup>

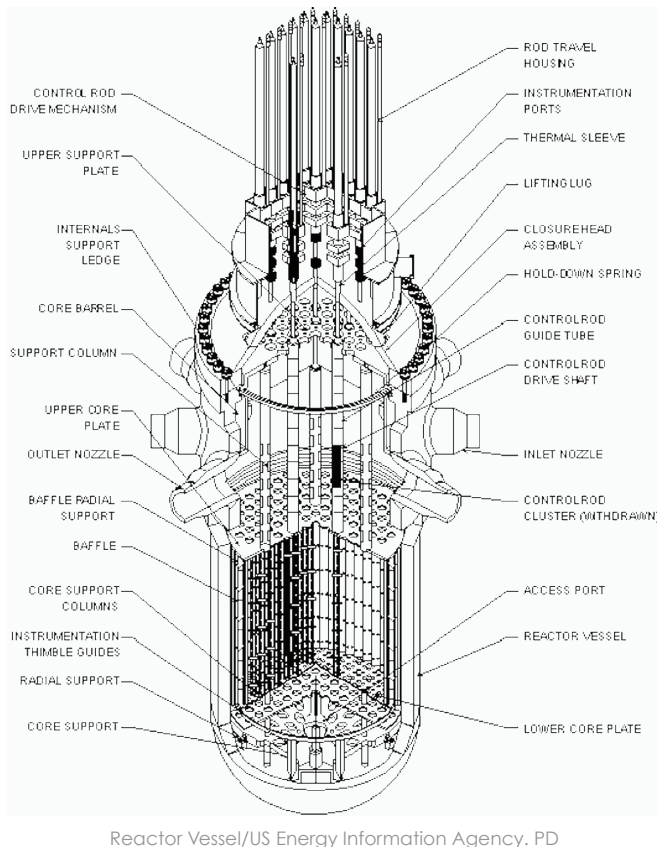

51. C.R.F. Azevedo, "A Review of Neutron-Irradiation- Induced Hardening of Metallic Components," *Engineering Failure Analysis* 18, No. 8 (Dec 2011): 1921-1942.

52. M. Ragheb, "Nuclear Marine Propulsion," *Rensselaer Polytechnic Institute*, 14 April 2015, <http://mragheb.com/NPRE%20402%20ME%20405%20Nuclear%20Power%20Engineering/Nuclear%20Marine%20Propulsion.pdf>.

53. *Ibid.*

Atomic effects corrosion is concerned with those types of degradation events associated with high-energy collisions, such as those caused by fast (0.1-10 MeV), intermediate (10eV-0.1 MeV), and/or thermal (0.025 eV at 20°C) fission-induced neutrons.<sup>54</sup> Fast neutrons tend to be the most destructive because they cause displacements within the lattice structures of the PWR materials. These displacements are a consequence of the elastic collision between a neutron and atoms within the material lattice. When displacement occurs it is because the energy of the incoming neutron is sufficiently high to overcome the bonds holding the atom within a lattice. This energy is known as the displacement energy ( $E_D$ ) and is dependent on the composition of the material and the structure of the material lattice.<sup>55</sup> For many metals this value is between 20-40 eV.<sup>56</sup> The amount of energy that can be transferred from a neutron to an existing lattice structure ( $E_m$ ) is dependent on the energy of the neutron and the atomic mass of the atoms within the material lattice.<sup>57</sup> When a neutron strikes an atom within a material lattice, it creates what is referred to as a fast moving primary knock-on atom (PKA).<sup>58</sup> This atom is ejected with energy equal to the difference between  $E_D$  and  $E_m$  (this difference is designated  $E_{PKA}$ ).<sup>59</sup> The ejected atom (i.e., PKA) moves with this energy and eventually elastically collides with other atoms in the lattice.<sup>60</sup> Other atoms will be ejected as long as the impacting atom has an  $E_m$  higher than that atoms  $E_D$ . The incoming neutron thereby creates a domino effect in which multiple atomic displacements are created producing vacancies and interstitial sites, which are called Frenkel defects.

The AEC resulting from the collision of the incoming neutron leads to what is referred to as a displacement cascade.<sup>61</sup> It creates clusters of vacancies within the displacement cascade surrounded by self-interstitial atoms. The numbers of displacement cascades that form over a given unit of time can be estimated. The estimate depends on the total number of Frenkel defects generated by a single PKA ( $N_d = 0.5 E_{PKA}/E_d$ ) and the total number of PKAs generated over a particular unit of time.<sup>62</sup> The total number of PKAs is estimated by calculating the product of the flux of neutrons ( $\Phi_n$ ) and the neutron elastic cross-section of an atom within a material lattice ( $\sigma_e$ ). At a neutron flux of  $10^{10}$  neutrons/cm<sup>2</sup>-s, for example, iron would experience approximately  $5.1 \times 10^{13}$  atomic displacements.<sup>63</sup> The typical neutron flux in a reactor's lifetime will almost certainly exceed this amount, meaning that a huge number of displacement cascades will occur in the pressure vessel throughout its life cycle. Therefore, it is important to consider AEC in pressure vessel designs.

The resulting PKA created from a fast neutron, and the corresponding displacement cascade that follows, is accompanied by a local temperature spike that last for a few

---

54. C.R.F. Azevedo, "A Review of Neutron-Irradiation- Induced Hardening of Metallic Components," *Engineering Failure Analysis* 18, No. 8 (Dec 2011): 1921-1942.

55. *Ibid.*

56. *Ibid.*

57. *Ibid.*

58. *Ibid.*

59. *Ibid.*

60. *Ibid.*

61. *Ibid.*

62. C. A. English and J. M. Hyde, "Radiation Embrittlement of Reactor Pressure Vessel Steels," In: I. Milne, R. O. Ritchie and B. Karihaloo, *Comprehensive Structural Integrity*, (Oxford, 2003): 351-398.

63. C.R.F. Azevedo, "A Review of Neutron-Irradiation- Induced Hardening of Metallic Components," *Engineering Failure Analysis* 18, No. 8 (Dec 2011): 1921-1942.

picoseconds. Depending on the material's composition and structure, the local temperature increase can be higher than the melting temperature of the local lattice structure, which can in turn cause further lattice defects. Other mechanisms that can impact the local lattice structure are the rebound effect that occurs as the lattice attempts to stabilize after the impact that initiated PKAs. The extent to which these effects take place within PWR materials, and their impact, depends on the reactor's operating temperature, specific chemical composition, and the microstructures that exist within the reactor's material.<sup>64</sup>

It is not currently possible to follow the precise individual AEC mechanisms and chains of mechanisms produced by neutron bombardment of a material. The damage that can be induced through a neutron collision with an atom in a material lattice structure is dependent on both intrinsic and extrinsic factors. Much of what is known regarding the processes is determined through molecular dynamic computations based on atomic scale modeling.<sup>65</sup> These simulations have helped understand that dislocations, grain boundaries and interfaces that naturally occur within the microstructures of PWR materials can act as defect sinks for radiation-induced defects.<sup>66</sup> The material's chemical composition, microstructures, and crystal lattice structure all influence the impact of atomic effects corrosion. The operating temperature, neutron radiation flux, exposure time, and other environmental stresses are also important factors in the creation and evolution of radiation-induced materials degradation (i.e., AEC).

Atomic scale modeling has also demonstrated that the type of crystal lattice packing can influence the types of lattice defects that manifest following exposure to high speed neutrons. Metals with either body-centered cubic or face-centered cubic crystal structures will have different types and distributions of lattice defects.<sup>67</sup> The extent to which radiation leads to degradation of mechanical properties within a PWR material depends on the type, size, spatial distribution, and mobility of the defects. This knowledge is currently limited to computational calculations, but as continued research makes it possible to design materials from the "atom up," atomic scale models will be essential in designing new materials for reactors that are naturally resistant to the impacts of atomic effects corrosion.

A typical PWR on a Navy submarine experiences around 40 years of operation and can be expected to experience neutron fluxes up to  $10^{23}$  neutrons/cm<sup>2</sup>-s.<sup>68</sup> This flux over such a long time will result in many displacement cascades through the reactor's life cycle: though individual collisions have effects at the atomic scale, the cumulative affect over time can result in changes observable on the macro scale. For example, displacement

---

64. Marquis A. Emmanuelle, "Nuclear reactor materials at the atomic scale," *Materials today* 12, No. 11 (2009): 30-37.

65. *Ibid.*

66. U.S. Nuclear Regulatory Commission, *Expert Panel Report on Proactive Materials Degradation Assessment* (Office of Nuclear Regulatory Research, Washington, DC, 2006), <http://pbadupws.nrc.gov/docs/ML0707/ML070710257.pdf>.

67. C.R.F. Azevedo, "A Review of Neutron-Irradiation- Induced Hardening of Metallic Components," *Engineering Failure Analysis* 18, No. 8 (Dec 2011): 1921-1942.

68. U.S. Nuclear Regulatory Commission, *Expert Panel Report on Proactive Materials Degradation Assessment* (Office of Nuclear Regulatory Research, Washington, DC, 2006), <http://pbadupws.nrc.gov/docs/ML0707/ML070710257.pdf>.

cascades can lead to hardening or embrittlement of the material's microstructures. Hardening/embrittlement increases the likelihood the material will fracture, particularly components that are made of metal alloys. Material hardening can lead to sudden

**A typical reactor on a Navy submarine is operated for 40 years and experiences high neutron fluxes.**

fracture, which in the high temperature and pressure environment of a reactor that fracture can lead to structural failure. In short, what started as an AEC-induced cascade can become in effect a "macro cascade" causing the reactor to fail unexpectedly. The PWR is the primary power source on a Navy submarine, and loss of this power source at the wrong time can be catastrophic. A complete understanding regarding the precise mechanisms of atomic effects corrosion on materials is needed to reduce the potential of such losses.

### *The Future of AEC in Nuclear Reactors*

The Navy's nuclear submarines have specific design requirements based on balancing the needed operational capabilities with the systems and technologies that provide them. For example, the overall size of the submarine and the variable buoyancy requirement (among other things) drive the weight and size of the reactor. Originally, PWRs were selected for Navy nuclear submarines because they could meet these design requirements. This choice was made at a time when the precise chemistry and physics regarding the interactions of radiation with matter were still immature. The relationships the effects of nuclear radiation and materials degradation pathways remained largely unknown during the design, construction, operation, and disposal of the first reactors on nuclear submarines. Safety and design improvements for submarine reactors were driven by empirical knowledge gained through operating experience. The designers simply could not address, *a priori*, atomic effects corrosion on the reactors because their effects were largely unknown; designers were unaware they could cause problems until after those problems occurred – *a posteriori*. Now that the Navy has been operating nuclear-powered submarines (and surface ships) for decades, and science has continued to advance during those same decades, this is no longer the case. A sufficient understanding of the bottom-up science regarding the interaction of radiation with materials is emerging, thanks to advances in atomic-scale computational modeling and imaging techniques such as the scanning probe microscope. This knowledge can be incorporated into the design, construction, operation, and disposal strategies for future nuclear reactors in military platforms. Current scientific knowledge already makes it clear that so doing, *a priori*, can lead to increased operational capabilities, safer submarines, and increased reactor life cycles.

**Navy nuclear submarine designs balance operational needs with systems and technologies.**

The SSBN(X) is intended to replace the Ohio Class Navy submarines; SSBN(X) designs are already being developed. As with all ship designs, SSBN(X) ship architects will use a "design spiral" approach that starts with design concepts and closes in on specific details later in the process. Thus, there is still time to consider the impacts, including AEC, of the choices that will be made during the final design process. In this book, we argue that a bottom-up science-based design approach can and should be used

to assist in designing future nuclear reactors. Employing a bottom-up design approach enables consideration of and planning for AEC-induced materials degradation in future reactors. Doing so can lead to selection and incorporation of more reliable materials into the reactor design. Along with improved predictive models, designs can assess safety, reliability, and potential failures. A “-up science approach is not limited to materials only; it can also address the radiation environment generated within the reactor. Both materials and radiation affect AEC degradation pathways.

Next-generation naval reactor designs may consider thorium-based reactors, or fuel alternatives such as relatively new low-enriched uranium fuel cycles.<sup>69</sup> One argument for low-enriched fuels is that the current requirement for highly-enriched uranium fuel offers potential adversaries (e.g., Iran) a legitimate rationale for developing highly-enriched uranium, which can also be used to make nuclear weapons. The use of highly-enriched uranium is currently permitted under the nuclear non-proliferation treaty because the United States (and others) use these fuels. As long as countries like the United States use highly-enriched fuels and reactor designs, other countries who want to develop a nuclear submarine program can make a legitimate claim for needing their own nuclear programs that make highly-enriched uranium.<sup>70</sup> The SSBN(X) is intended to remain in operation for 40 years, and the construction design phase set to begin in 2017.<sup>71</sup> Thus, the choices made in SSBN(X) design and development will have major implications in both military and political arenas regarding global nuclear power.

Bryan Clark from the NNSA, a key figure in the design of the SSBN(X), has spoken about the new capabilities nanotechnologies can enable in nuclear reactor designs.<sup>72</sup>

*“With nanotechnology you are able to precisely control the exact structure of the fuel cells. And with computer modeling and new processing power you can really look at this stuff at a high level of resolution and detail. Those two things will allow engineers to hand-tool the fuel construction in a way that is going to make it last a lot longer than previous generation’s power plants.”*

In 2009, then U.S. Congressman Joe Sestak (a former Navy admiral) sought to push the Pentagon to embrace thorium-based reactors for the design of a thorium-fueled ship.<sup>73,74</sup> In some ways, this was a response to what nations like China were doing with these technologies. Congressman Sestak proposed that the Navy should be at least considering reactor designs that use alternative fuel cycles like thorium as they move to replace

- 
69. Nate Sans, “Why the United States should redesign its nuclear submarines,” *Bulletin of the Atomic Scientists*, 3 Sept 2013, Accessed 6 Oct 2015, <http://thebulletin.org/why-united-states-should-redesign-its-nuclear-submarines>.
70. Douglas Birch, “Navy should develop new ship and sub reactors that don’t use weapons-grade uranium, experts say,” *The Center for Public Integrity*, 19 March 2015, Accessed 6 Oct 2015, <http://www.publicintegrity.org/2015/03/19/16931/navy-should-develop-new-ship-and-sub-reactors-don-t-use-weapons-grade-uranium>.
71. Stew Magnuson, “Nuclear Power Plants on New Submarines May Last 40-Plus Years,” *National Defense Magazine*, Feb 2015, Accessed 7 Oct 2015, <http://www.nationaldefensemagazine.org/archive/2015/February/Pages/NuclearPowerPlantsonNewSubmarinesMayLast40PlusYears.aspx>.
72. *Ibid.*
73. David Lague and Charlie Zhu, “Special Report: The U.S. government law behind Chain’s nuclear power push,” *Reuters*, 20 Dec 2013, Accessed 6 Oct 2015, <http://www.reuters.com/article/2013/12/20/us-breakout-thorium-special-report-idINBRE9BJORH20131220>.
74. David Lague and Charlie Zhu, “Special Report: The U.S. government law behind Chain’s nuclear power push,” *Reuters*, 20 Dec 2013, Accessed 6 Oct 2015, <http://www.reuters.com/article/2013/12/20/us-breakout-thorium-special-report-idINBRE9BJORH20131220>.

the Ohio Class, and that it would be unfortunate if a country like China was able to obtain a better nuclear submarine by using a reactor and materials designed around a thorium fuel cycle.<sup>75</sup> Ironically, the Chinese obtained the information on how to build thorium nuclear reactors by engaging with Oak Ridge National Laboratories. Essentially, a complete, bottom-up science-based approach can consider all alternatives, including different reactor types, to assess the potential of different methods to design systems with superior performance and resistance to the impacts of AEC.

Military and political considerations are not the only aspects a bottom-up design can address. Refueling a nuclear reactor core currently costs almost one billion dollars. If reactors can be designed using a bottom-up approach to reduce the frequency of refueling and increase their life-cycles, the result could significantly reduce the total cost of future reactors. The Navy will need to decide soon on the new design and development plan for SSBN(X). Some within the Navy have already expressed concerns that budget constraints will reduce the numbers of SSBN(X) in the fleet.<sup>76</sup> A more complete, bottom-up science based design of the nuclear reactor systems to be used in the SSBN(X) may lead to better, more precise cost estimations. In addition, if materials can be optimized – made better and more efficient at lower total cost – by incorporating science-based design criteria for major systems (and addressing AEC and other degradation mechanisms), such designs might lead to more capable nuclear submarines, fewer problems during development, and thus fewer cost overruns. The result could offset some of the SSBN(X) development costs, and potentially lead to being able to procure more of the new submarines. In sum, the more the SSBN(X) program relies on the best available science regarding nuclear reactor designs, the less likely unexpected problems will arise. As a result, the Navy may be better able to control the cost, schedule and technical risks of developing the next generation of nuclear submarines.

The U.S. Nuclear Regulatory Commission (NRC) has developed a strategy that could help in the Navy's search for new nuclear powered submarines.<sup>77</sup> The Progressive Materials Degradation Approach attempts to develop a foundation for identifying appropriate actions to prevent materials degradation from leading to reactor failures. Part of this

**The U.S. NRC strategy could help the Navy's new nuclear submarine design.**

approach is predicting which properties within material microstructures could lead to future failures due to the AEC-prone environment of nuclear reactors. It would be beneficial for the Corrosion Policy Office (CPO) to investigate this approach and incorporate applicable principles into its corrosion prevention and control (CPC) strategies and policies throughout the corrosion spectrum.

75. "Would Thorium Powered Ships be better for the Navy?" *Yottawatts From Thorium* (blog), 2 Feb 2010, <http://yottawattsthorium.blogspot.com/2010/02/thorium-powered-ships-for-navy.html>.

76. "SSBNX Under Pressure: Submarine Chief Says Navy Can't Reduce," *Federation of American Scientists*, 24 July 2013, Accessed 7 Oct 2015, <http://fas.org/blogs/security/2013/07/ssbnx-numbers/>.

77. U.S. Nuclear Regulatory Commission, *Expert Panel Report on Proactive Materials Degradation Assessment* (Office of Nuclear Regulatory Research, Washington, DC, 2006), <http://pbdupws.nrc.gov/docs/ML0707/ML070710257.pdf>.



# GLOSSARY OF ACRONYMS

<b>Acronym</b>	<b>Definition</b>
ACAT	Acquisition Category
AEC	Atomic Effects Corrosion
AFCAD	Alternative Futures for Corrosion and Degradation
ASTM	American Society for Testing and Materials
ATOX	Atomic Oxygen
BJT	Bipolar Junction Transistor
BPP	Burnable Poison Particle
CDR	Charge Depletion Region
CFR	Constant Failure Rate (model)
CME	Coronal Mass Ejection
CPC	Corrosion Prevention and Control
CPO	Office of Corrosion Policy and Oversight/Corrosion Policy Office
DARPA	Defense Advanced Research Projects Agency
DD	Displacement Damage
DMEA	Defense Microelectronics Activity
DNA	Deoxyribonucleic Acid
DoD	Department of Defense
DoDI	Department of Defense Instruction
DoE	Department of Energy
ELF	Early Life Failures
FET	Field Effect Transistor
FIT	Failure in Time
FPGA	Field Programmable Gate Array
HCI	Hot Carrier Injection
IC	Integrated Circuit
IR	Infrared
JFET	Junction Field Effect Transistor
LED	Light Emitting Diode
LEP	Life Extension Program
LET	Linear Energy Transfer
MEMS	Micro-Electro-Mechanical Systems
MIL-HDBK	Military Handbook
MOSFET	Metal Oxide Semiconductor Field Effect Transistor
MRI	Magnetic Resonance Imaging or Imagers
MTTF	Mean Time to Failure
NASA	National Aeronautics and Space Administration
NEMS	Nano-Electro-Mechanical Systems
NNSA	National Nuclear Security Administration

NRC	Nuclear Regulatory Commission
OSD	Office of the Secretary of Defense
PIPS	Potomac Institute for Policy Studies
PKA	Primary Knock-on Atom
PV	Photovoltaic
PVC	Polyvinyl Chloride
PWR	Pressurized Water Reactor
RAM	Random Access Memory
RDT&E	Research, Development, Test and Evaluation
SEB	Single Event Burnout
SEE	Single Event Effect
SEL	Single Event Latchup
SET	Single Event Transient
SEU	Single Event Upset
SRAM	Static Random Access Memory
SSBN	U.S. Navy Nuclear Ballistic-missile Submarine
SSGN	U.S. Navy Nuclear Guided-missile Submarine
SSN	U.S. Navy Nuclear Submarine
STR	Submarine Thermal Reactor
TID	Total Ionizing Dose
TOW	Tube-launched, Optically-tracked, Wire-guided (missile)
UAV	Unmanned Aerial Vehicle
UHV	Ultrahigh Vacuum
UV	Ultraviolet
VHSIC	Very High-Speed Integrated Circuit
VSEPR	Valence Shell Electron Pair Repulsion (theory)
WWII	World War II

# IMAGE CREDITS

**“Artist’s conception of a gamma ray collision in a semiconductor lattice”, on cover and title page** by Alex Taliesen.

**“The Corrosion Spectrum- Arrow”** by Alex Taliesen.

**“Evolution of lighting”** vexworldwide/Image ID: 280630649/www.shutterstock.com.

**“Jet Fighter Aircraft Mesh. Part of a series”** by Nuno Andre/Image ID: 120354058/www.shutterstock.com.

**“computer motherboard closeup”** by chungking/Image ID: 258734219/www.shutterstock.com.

**“Scrap Metal Pile - Collage”** Zorandim/ Image ID: 171575675/www.shutterstock.com.

**“Corrosion Spectrum Diagram”** by Alex Taliesen.

**“Rear view of businessman touching icon of media screen”** Khakimullin Aleksandr/Image ID: 201328007/www.shutterstock.com.

**“Artist’s conception of a gamma ray collision in a semiconductor lattice”** by Alex Taliesen.

**“The Corrosion Spectrum- Arrow”** by Alex Taliesen.

**“Laptop”** by Alex Taliesen.

**“The Atom”** by Alex Taliesen.

**“The three isotopes of hydrogen”** “Protium deuterium tritium” by Lamiot for french version, from Dirk Hünninger - self, translation from Dirk Hünninger (german wikipedia). Licensed under CC BY-SA 3.0 via Wikimedia Commons. [https://commons.wikimedia.org/wiki/File:Periodic\\_trends.svg](https://commons.wikimedia.org/wiki/File:Periodic_trends.svg).

**“Diagram of the various periodic trends”** by Mirek2 (Own work) [CC0 1.0 Universal.], via Wikimedia Commons [https://commons.wikimedia.org/wiki/File:Periodic\\_trends.svg](https://commons.wikimedia.org/wiki/File:Periodic_trends.svg).

**“Forming and dissolving of table salt”** by Alex Taliesen.

**“Oxidation and Reduction”** by Alex Taliesen.

**“Chemical reaction”** by Aushulz (Own work) [CC BY-SA 3.0 (<http://creativecommons.org/licenses/by-sa/3.0/>)], via Wikimedia Commons. [https://commons.wikimedia.org/wiki/File:Chemical\\_reactions.svg](https://commons.wikimedia.org/wiki/File:Chemical_reactions.svg).

**“CMS: Simulated Higgs to two jets and two electrons.”** Image creator: Lucas Taylor. CERN. <http://cds.cern.ch/record/628469>.

**“Lightning”** by Timothy Kirkpatrick (Lightning pics) [Public domain], via Wikimedia Commons. <https://commons.wikimedia.org/wiki/File:Lightning.0257.jpg>.

**“Illustration of a hypothetical nucleus which can undergo many different types of radioactive decay.”** Generated by Kieran Maher using Aldus SuperPaint. [Public domain], via Wikimedia Commons. [https://en.wikibooks.org/wiki/File:Radioactive\\_decay.gif](https://en.wikibooks.org/wiki/File:Radioactive_decay.gif).

**“Comparison of sizes of semiconductor manufacturing process nodes with some microscopic objects and visible light wavelengths”** by Cmglee (Own work) [CC BY-SA 3.0], via Wikimedia Commons [https://commons.wikimedia.org/wiki/File:Comparison\\_semiconductor\\_process\\_nodes.svg](https://commons.wikimedia.org/wiki/File:Comparison_semiconductor_process_nodes.svg).

**“Boiling water reactor system diagram”** by Robert Steffens (alias RobbyBer 8 November 2004), SVG: Marlus\_Gancher, Antonsusi (talk) using a file from Marlus\_Gancher. See File talk:Schema Siedewasserreaktor.svg#License history [GFDL (<http://www.gnu.org/copyleft/fdl.html>)], via Wikimedia Commons. [https://commons.wikimedia.org/wiki/File:Boiling\\_water\\_reactor\\_english.svg](https://commons.wikimedia.org/wiki/File:Boiling_water_reactor_english.svg).

**“Nuclear Waste Barrels”** Flickr, Iwan Gabovitch CC0 Public Domain, (CC BY 2.0) <https://www.flickr.com/photos/qubodup/6992896138/in/photostream>.

**“Standardized Temperature Profile.”** Image credit: National Weather Service. <http://www.srh.noaa.gov/srh/jetstream/atmos/atmprofile.htm>.

**“Sources of Ionizing Radiation in Interplanetary Space.”** Image credit: NASA/JPL-Caltech/SwRI. [http://photojournal.jpl.nasa.gov/jpegMod/PIA16938\\_modest.jpg](http://photojournal.jpl.nasa.gov/jpegMod/PIA16938_modest.jpg).

**“Microelectronics computer chip background”** Kichigin/ Image ID: 305009663/www.shutterstock.com.

**“CPO”** by ra2studio. Shutterstock Image ID: 243157867/www.shutterstock.com.

**“Woman Doctor scientist in nuclear- electronic laboratory”** by Fineart1/Image ID: 105763097/www.shutterstock.com.

**“Silver Sulfide Whiskers growing out of surface-mount resistors from a Moog DS2000 servodrive”** by JonathonReinhart (Own work) [Public domain], via Wikimedia Commons. <https://upload.wikimedia.org/wikipedia/commons/4/48/SilverSulfideWhiskers1.jpg>.

**“Nuclear power plant.”** www.pixabay.com [PD.] <https://pixabay.com/en/nuclear-reactors-nuclear-power-plant-499907/>.

**“Logistics-truck-freight-train-877567”** geralt. [PD] <https://pixabay.com/en/logistics-truck-freight-train-877567>.

**“Experience in microchip life cycles”** by Alex Taliesen.

**“Overview of the main types of Scannig Probe Microscope types.”** Illustration by Kristian Molhave. Opensource Handbook of Nanoscience and Nanotechnology. [https://commons.wikimedia.org/wiki/File:SPM\\_overview.jpg](https://commons.wikimedia.org/wiki/File:SPM_overview.jpg).

**“Four Laws of Thermodynamics”** by Alex Taliesen.

**“ClipartOf.com.”** 3d rendered single red cube at the bottom of a crumbling tower of white cubes by Tonis Pan, COLLC0042.

**“Forcing atoms into dense spaces can lead to the creation of unique orbital configurations that allow for the delocalization of electrons.”** Image credit: Alex Taliesen.

**“Vibrations of Atoms.”** Image credit: Alex Taliesen.

**“Magnetic Moments from Orbital Movement and Spin.”** Image credit: Alex Taliesen.

**"Ruby Laser Beam"** by Mcgill Mcgill - self-made. Licensed under Public Domain via Wikibooks - [https://en.wikibooks.org/wiki/File:Ruby\\_laser\\_beam.png#/media/File:Ruby\\_laser\\_beam.png](https://en.wikibooks.org/wiki/File:Ruby_laser_beam.png#/media/File:Ruby_laser_beam.png).

**"Periodic Table of Elements"** Periodic Table Of Elements With Color Delimitation/Maximilian Laschon/ Image ID: 172309694/www.shutterstock.com.

**"Microscopic structure of steel."** Webcorr. [https://commons.wikimedia.org/wiki/File:Microstructure\\_of\\_a\\_sensitized\\_type\\_304\\_stainless\\_steel.jpg](https://commons.wikimedia.org/wiki/File:Microstructure_of_a_sensitized_type_304_stainless_steel.jpg).

**"Bond geometries associated with valence-shell electron-pair repulsion theory (VSEPR)."** (CC BY-SA 3.0) <https://commons.wikimedia.org/wiki/VSEPR>.

**"Critical Radius Ratio"** by Matthew Rollings. PD. <https://commons.wikimedia.org/wiki/File:Criticalradiusratio.png>.

**"Spinel Structure"** by Perditax, PD. [https://commons.wikimedia.org/wiki/File:Spinel\\_structure.png](https://commons.wikimedia.org/wiki/File:Spinel_structure.png).

**"Chemical structure of Quartz"** by Wimmel (Own work) [Public domain], via Wikimedia Commons. [https://commons.wikimedia.org/wiki/File:SiO%C2%B2\\_Quartz.svg](https://commons.wikimedia.org/wiki/File:SiO%C2%B2_Quartz.svg).

**"The amorphous structure of glassy Silica (SiO<sub>2</sub>) in two-dimensions"** by Wimmel (Own work) [Public domain], via Wikimedia Commons. <https://commons.wikimedia.org/wiki/File:Silica.svg>.

**"Crystal Lattice Point Defects"** by Alex Taliesen.

**"Examples of traditional ceramics."** Attribution 4.0 International (CC BY 4.0) <http://www.scielo.br/img/revistas/ce/v60n354/a16fig05.jpg>.

**"MEMS microcantilever resonating in an SEM"** by Pcflot01 at en.wikipedia [CC BY-SA 3.0 (<http://creativecommons.org/licenses/by-sa/3.0/>) from Wikimedia Commons. [https://upload.wikimedia.org/wikipedia/commons/3/34/MEMS\\_Microcantilever\\_in\\_Resonance.png](https://upload.wikimedia.org/wikipedia/commons/3/34/MEMS_Microcantilever_in_Resonance.png).

**"The effect of applied voltage on piezoelectric materials"** by Creepin475 (Own work) [CC BY-SA 3.0 (<http://creativecommons.org/licenses/by-sa/3.0/>) <https://commons.wikimedia.org/wiki/File:Piezoelectric.JPG> via Wikimedia Commons.

**"Basic structure of an n-channel MOSFETs in cross-section (planar)"** translated from German "Prinzipieller Aufbau eines n-Kanal-MOSFETs im Querschnitt" by PNG-Version: Markus A. Hennig (17. Dezember 2005) SVG-Umsetzung Cepheiden (:Datei:N-Kanal-MOSFET.png) [GFDL (<http://www.gnu.org/copyleft/fdl.html>) or CC-BY-SA-3.0 (<http://creativecommons.org/licenses/by-sa/3.0/>)], via Wikimedia Commons [https://upload.wikimedia.org/wikipedia/commons/a/ad/N-Kanal-MOSFET\\_%28Schema%29.svg](https://upload.wikimedia.org/wikipedia/commons/a/ad/N-Kanal-MOSFET_%28Schema%29.svg).

**"Nanotubes: armchair or zigzag"** by W2raphael (Own work) [Public domain], via Wikimedia Commons. [https://commons.wikimedia.org/wiki/File:Nanotubos\\_enrolamento.PNG](https://commons.wikimedia.org/wiki/File:Nanotubos_enrolamento.PNG).

**"Ethane three dimensional bonding structure"** by Alex Taliesen.

**"Differing ethane rotational orientations"** by Alex Taliesen.

**"Different linkages of copolymers"** by Alex Taliesen.

**“Schematic of an organic field effect transistor”** by MaterialsScientist - Own work. Licensed under CC BY-SA 3.0 via Wikimedia Commons - <https://commons.wikimedia.org/wiki/File:OfetEng.png#/media/File:OfetEng.png>.

**Diagram of the diffusion across a pn junction, with the resultant uncovered space charges, the electric field and the drift currents”** by Inductiveload (Own work (Own Drawing)) [Public domain], via Wikimedia Commons [org/wiki/File:Pn\\_Junction\\_Diffusion\\_and\\_Drift.svg](https://commons.wikimedia.org/wiki/File:Pn_Junction_Diffusion_and_Drift.svg).

**The basic operation of an NPN BJT in Active mode.** By Inductiveload [https://commons.wikimedia.org/wiki/File:NPN\\_BJT\\_Basic\\_Operation\\_\(Active\).svg](https://commons.wikimedia.org/wiki/File:NPN_BJT_Basic_Operation_(Active).svg) [PD].

**“Field effect transistor of the n-p-n type”** by Cyril BUTTAY [CC BY-SA 3.0] <https://creativecommons.org/licenses/by-sa/3.0/deed.en>. [https://commons.wikimedia.org/wiki/File:Lateral\\_mosfet.svg](https://commons.wikimedia.org/wiki/File:Lateral_mosfet.svg).

**“Scheme of n-junction field-effect transistor de”** by Norro. CC BY-SA 2.5. [https://commons.wikimedia.org/wiki/File:Scheme\\_of\\_n-junction\\_field-effect\\_transistor\\_de.svg#/media/File:Scheme\\_of\\_n-junction\\_field-effect\\_transistor\\_de.svg](https://commons.wikimedia.org/wiki/File:Scheme_of_n-junction_field-effect_transistor_de.svg#/media/File:Scheme_of_n-junction_field-effect_transistor_de.svg).

**“A visual representation of grain boundaries”** by Wlytle1375 [https://upload.wikimedia.org/wikipedia/commons/4/40/Grain\\_boundary\\_diagram.jpg](https://upload.wikimedia.org/wikipedia/commons/4/40/Grain_boundary_diagram.jpg) [PD].

**“Reactor Plant Schematic.”** NNSA DoE. [http://nnsa.energy.gov/sites/default/files/nnsa/inlinefiles/Reactor\\_Plant\\_Schematic\\_print.pdf](http://nnsa.energy.gov/sites/default/files/nnsa/inlinefiles/Reactor_Plant_Schematic_print.pdf).

**“Typical nuclear submarine reactor compartment location”** by Alex Taliesen.

**“Reactor pressure vessel”** [http://www.eia.doe.gov/cneaf/nuclear/page/nuc\\_reactors/pwr.html](http://www.eia.doe.gov/cneaf/nuclear/page/nuc_reactors/pwr.html), <https://commons.wikimedia.org/wiki/File:Reactorvessel.gif>. US Energy Information Agency. PD.

# INDEX

## A

Admiral Rickover 159  
advanced polymers 136  
allotropes 106, 124, 125  
alloys 34, 49, 104, 108, 109, 123, 162, 166  
alpha particles 151, 152  
Alternative Futures for Corrosion and Degradation Research (AFCAD) xi, 14, 21, 24, 25, 26, 34, 50  
amorphous 106, 117, 118, 129, 131, 133, 135  
anions 114, 115, 116  
atomic effects corrosion (AEC) vii, ix, x, 13, 15, 16, 21, 29, 41, 44, 62, 63, 69, 85, 87, 139, 158, 160, 165, 166  
atomic geometries 32  
atomic, micro, macro configuration vii, ix, x, 13-47, 54, 56, 60, 62, 63, 69, 70, 72-78, 83, 85-89, 91, 93-97, 99-104, 106-127, 130, 133-136, 138-150, 156-166  
atomic packing factor 107  
atomic point defects 119, 122  
atomic properties 15, 42, 44, 93, 95, 97, 103, 113, 133, 150, 156  
atomic radii 115  
atomic scale modeling 165  
atomic structures 19, 88, 89, 94, 96, 97, 102, 108, 110, 113, 114, 117-119, 121, 123, 133, 138

## B

Bell Telephone Laboratories 141  
biological effects corrosion ix, xi, 21, 25, 26, 34, 63, 65, 66, 69, 70, 72, 84, 85, 138  
bipolar junction transistor (BJT) 146  
bipolar transistor 141  
bottom-up 80, 88, 95, 108, 134, 136, 155, 156, 157, 158, 162, 166, 167, 168  
Bronze Age 17

## C

cancer 30, 71, 73, 74  
capacitors 141, 143, 144, 149, 151  
carbon-14 17  
cations 114, 115, 116  
ceramics 16, 31, 34, 88, 89, 112-122, 124, 125, 129-134, 162  
chemical reaction 26, 29, 41  
China 16, 167, 168  
classical corrosion 13, 15, 16, 18, 22, 25, 26, 29-31, 34, 37, 40-48, 53, 56, 61-76, 81, 83, 84, 86, 110, 121, 123, 127, 135, 160, 161, 163  
coatings ix, 24, 56, 134, 136  
commercial IC 142  
composites 31, 34, 88, 89, 138  
conduction band 126  
conductor 127, 134  
constant failure rate (CFR) 156  
coordination number 107, 115  
Copper Age 17  
corrosion vii, ix, x, xi, 13-18, 20-22-34, 37, 40-42, 44-56, 61-76, 81-89, 93, 95, 108, 110, 111, 121-123, 127, 134, 135, 138-141, 150, 152, 156, 158, 160-168  
corrosion byproduct buildup 50

corrosion mitigation 71  
corrosion prevention vii, 21, 64, 66, 69, 87, 141, 156, 168  
corrosion prevention and control (CPC) 69, 87, 141, 156, 168  
corrosion spectrum ix, x, xi, 14, 22, 27, 29, 31, 33, 63, 64-69, 71-76, 84-86, 140, 141, 168  
covalent bond 113  
CPO mission 67  
crystal lattice 59, 61, 93, 94, 98, 100, 102, 104, 106, 110, 115, 122, 124, 125, 137, 154, 155, 165  
current 14, 15, 22, 24, 48, 51, 53, 58, 61, 66, 67, 72, 77, 95, 97, 100, 109, 137, 141, 144, 145, 146, 147, 148, 149, 150, 154, 155, 158, 167

## D

DARPA 72, 169  
decay x, 14, 15, 20, 26, 29, 30, 34, 35, 36, 41, 43, 44, 49, 51, 60, 93, 95, 100, 103, 151, 159  
de Havilland aircraft 18  
delocalization of electrons 40, 96, 107, 131  
Department of Defense (DoD) vii, 13, 139, 143, 169  
Department of Energy (DoE) 24, 53, 139, 159, 169  
diamagnetism 100  
diffusion 43, 44, 93, 95, 100, 104, 111, 119, 120, 127, 145  
Diffusion 120  
diode 97, 126, 141, 145, 146, 151  
dipole interactions 112, 133  
dislocations 97, 111, 165  
displacement 57, 81, 94, 95, 100, 108, 111, 120, 121, 122, 125, 164, 165  
displacement energy 164  
DNA 123, 129, 130, 169  
doping 60, 126, 127, 146, 147

## E

elastomers 135, 136  
electrical conductivity 95, 131, 135  
electrical energy 125  
electrical resistance 96, 142, 144  
electric field 61, 95, 99, 145, 148, 153, 154  
electromagnetic field 24  
electromagnetic radiation 54, 102, 103, 155  
electron configuration 37, 39, 104, 105  
electronegativity 38, 39, 40, 97, 112  
electronic bond geometries 113  
electronic geometries 96, 113  
electronics 42, 47, 51, 61, 78, 95, 102, 137, 138, 141, 142, 143, 144, 145, 149, 152  
electrons 15, 34-42, 45, 59, 61, 96, 99-107, 112, 113, 115, 126, 130, 131, 134, 141, 143-151, 154, 155  
energy x, 14, 15, 26, 36, 37, 38, 41, 42, 44, 47, 49, 50, 52, 53, 56, 59, 60, 61, 81, 85, 90, 91, 92, 93, 97, 98, 99, 102, 103, 104, 111, 113, 114, 120, 124, 125, 126, 134, 140, 151, 152, 154, 155, 158, 159, 160, 161, 163, 164  
energy band gaps 97, 102, 104  
energy gap 126  
enthalpy 92, 130  
entropy 43, 82, 90, 91, 92, 130  
equilibrium 90, 91, 92, 98

European Space Agency (ESA) 54  
excited state 102

## F

ferrimagnetism 100  
ferromagnetism 100  
Field effect transistor (FET) 147  
field forces 41, 44  
fracture toughness 93, 123  
functional groups 98, 132, 133

## G

galactic cosmic ray 151  
galvanic corrosion 21  
grain boundary 108, 111, 154, 155  
grain size 111  
graphene 94, 124, 125, 127, 128, 130  
ground state 102, 103, 104

## H

hard disk drives 101, 124  
hardening 55, 72, 166  
heat capacity 98  
helium 35  
high-energy collisions x, 14, 15, 26, 41, 42, 114, 164  
hillocks 154  
hydrocarbon 129, 130, 131, 133, 136  
hydrogen 35, 89, 129, 130, 131

## I

inductors 143, 144, 145  
Industrial Age 13, 24  
Information Age ix  
inorganic 112, 137, 138  
insulator 61, 127  
integrated circuits (IC) 123, 155  
interconnects 141, 142, 153, 154, 155, 156  
ionic bond 39  
ionic radii 114, 115  
ionization 19, 24, 39, 42, 58, 61, 104, 122, 151  
ions 29, 31, 34, 38, 39, 40, 41, 45, 90, 102, 103, 106, 112-116, 118-122, 133, 144, 153, 154  
iron ix, 13, 17, 24, 35, 36, 39, 40, 88, 107, 109, 110, 111, 120, 164  
Iron Age ix, 17, 21

## J

JASON 49

## L

lattice defects 61, 111, 120, 122, 165  
lattice designations 115  
lattice structure 59, 91, 93, 97, 98, 102, 106, 116, 120, 154, 164, 165  
Life Extension Programs 49  
light emitting diodes 103  
linear energy transfer (LET) 59, 151  
low-energy collisions 26, 41, 44

## M

macrostructures 29, 31, 88, 107, 108  
magnetic domains 101

magnetic field 47, 100, 145  
magnetic flux density 100  
magnetic moment 100, 102  
magnetic tapes 101  
magnetization 100, 101  
material lattice 30, 73, 164, 165  
material migration 153  
materials degradation vii, ix, x, 14, 22, 25, 26, 29, 40, 44, 45, 48, 63, 67, 73, 76, 86, 87, 91, 140, 141, 156, 157, 160, 162, 165, 166, 167, 168  
material sustainment vii, ix, x, xi, 14, 15, 16, 17, 18, 20, 21, 22, 24, 26, 27, 31, 34, 44, 45, 48, 62, 63, 64, 65, 67, 68, 70, 71, 76, 77, 83, 85, 86, 90, 105, 138, 140, 141, 143, 150, 153, 155, 156, 157, 162  
mean time to failure (MTIF) 154  
mechanical energy 125  
MEMS actuator 122  
metal fatigue 18  
metalloids 104, 105, 125  
metals 16, 20, 21, 24, 31, 32, 34, 39, 51, 52, 84, 88, 89, 94, 96, 97, 102, 103, 104, 105, 106, 107, 108, 109, 112, 113, 114, 115, 118, 119, 120, 121, 125, 129, 130, 132, 133, 134, 138, 162, 164  
microchips 13, 19, 21, 44, 57, 59, 71, 72, 79, 80, 81, 82, 83, 145, 151, 152  
microelectronics vii, ix, 15, 18, 21, 24, 26, 29, 45, 46, 47, 48, 51, 57, 59, 60, 61, 62, 70, 71, 74, 77, 88, 97, 101, 108, 113, 121, 125, 126, 127, 137, 138, 139, 140, 141, 142, 143, 144, 145, 146, 149, 150, 151, 152, 153, 154, 155, 156, 157  
microfracturing 122  
MIL-HDBK-217 series 156  
molecular structures 32, 40, 43, 89, 93, 129, 130, 132, 133, 135, 136, 138  
molecules x, 13, 14, 15, 19, 29, 31, 32, 34, 37, 39, 40, 41, 43, 47, 60, 85, 89, 90, 98, 100, 102, 112, 114, 120, 122, 130, 133, 137  
MOSFET transistors 97

## N

NACE 13, 127  
nanoelectromechanical systems (NEMS) 95  
nanotechnology 46, 127, 152, 167  
National Aeronautics and Space Administration (NASA) 46, 169  
National Nuclear Security Administration (NNSA) 49, 169  
natural polymers 129  
Navy vi, 65, 139, 140, 158, 159, 160, 162, 165, 166, 167, 168, 170  
Navy nuclear powered submarines 140  
net charge 115  
neutron 30, 34, 35, 36, 42, 58, 59, 61, 73, 125, 127, 139, 151, 152, 161, 163, 164, 165, 166  
neutrons 15, 34, 35, 37, 42, 55, 114, 127, 139, 151, 155, 163, 164, 165  
neutron transmutation 127  
non-metals 88, 89, 103, 104, 105, 106, 112, 113, 114, 125, 130, 132, 133, 138  
nuclear power plants 47, 48, 50, 51, 52, 53, 62, 64, 111  
nuclear waste 24, 29, 45, 48, 52, 53, 54, 62  
nuclear waste disposal 29, 62  
nuclear weapons ix, 13, 29, 45, 46, 48, 49, 52, 53, 59, 62, 65, 70, 71, 73, 74, 80, 139, 159, 167



nucleus 30, 34, 35, 36, 37, 41, 42, 43, 73, 85, 100, 151

## O

Oak Ridge National Laboratories 168

Office of Corrosion Policy and Oversight (CPO) vii, 83, 169

Office of the Secretary of Defense (OSD) vii, 13, 156, 170

Og 22, 66, 76, 77

Operation HARDTACK 139

orbital 36, 37, 47, 54, 59, 96, 97, 100, 101, 104, 105, 126, 131, 137

organic x, 14, 69, 89, 130, 134, 137, 138

organic semiconducting materials 138

organic semiconductors 137, 138

outer space 47, 48, 54, 62, 152

oxidation-reduction reactions 44, 113

## P

paramagnetism 100

periodic table 36, 37, 38, 39, 88, 89, 104, 112, 130

permeability 100

phonons 98

photoconductivity 103

physics-of-failure 157

piezoelectric ceramics 124, 125

piezoelectricity 124

plastic deformation 94

plastics 24, 134, 135

p-n junction 126

polymer crystals 133

polymeric fibers 136

polymers 19, 24, 31, 34, 88, 89, 129, 130, 131, 132, 133, 134, 135, 136, 137, 138

potential 44, 73, 74, 76, 87, 91, 92, 100, 108, 118, 127, 137, 138, 143, 155, 157, 166, 167, 168

Potomac Institute for Policy Studies ii, xi, xii, 14, 170

pressurized water reactors 158, 159, 160

primary knock-on atom 164

proton 34, 35, 36, 42

## Q

quantum effects 15, 46, 60

## R

radiation 19, 21, 24, 30, 42, 43, 45, 47, 50, 51, 52, 54, 55, 56, 57, 58, 59, 60, 61, 72, 73, 79, 80, 81, 83, 102, 103, 114, 137, 138, 139, 140, 150, 151, 152, 153, 155, 161, 162, 163, 165, 166, 167

radiation tolerant (rad hard) 79

radioactivity 34, 35, 51, 53, 57

repeating units 129, 131, 132

research directions xi, 75, 76, 77

resistance 60, 95, 96, 110, 136, 142, 144, 147, 149, 168

resistors 143, 144

ruby laser 103

rust ix, x, 13, 14, 17, 24, 39, 40, 109

## S

salt 38, 39, 116, 159

scanning probe microscope 87, 95, 166

Schottky 120

self-interstitial atoms 97, 164

semiconductors 19, 51, 57, 103, 108, 113, 137, 138, 145

silica 19, 98, 118, 121, 125

silicates 117, 118

silicon 56, 57, 59, 60, 61, 89, 96, 108, 117, 118, 121, 122, 123, 125, 126, 127, 137, 151

silicon carbonitrides 123

silicon semiconductors 57

single event burnouts (SEB) 57, 81, 152

single event effects (SEE) 46, 57, 150

single event latchup (SEL) 57, 150

single event transients (SET) 57, 152

single event upsets (SEU) 81

sodium chloride 115, 116

spontaneous degradation 41, 43, 85

SRAM memory chips 151

SSBN(X) 158, 166, 167, 168, 170

stainless steel 51, 110, 162

state 20, 41, 50, 57, 67, 70, 71, 83, 91, 92, 102, 103, 104, 105, 108, 117, 130, 133, 137, 140, 141, 142, 143, 145, 149, 156, 163

steel 13, 17, 24, 51, 88, 94, 108, 109, 110, 111, 112, 161, 162

steel alloys 108, 109

Stockpile Stewardship Program 49

stress corrosion cracking 24, 50

Submarine Thermal Reactor 159, 160, 170

surroundings 47, 90, 92

synthetic polymers 129, 132, 134

system 20, 21, 24, 26, 30, 31, 45, 50, 53, 59, 73, 77, 79, 80, 82, 85, 86, 90, 91, 92, 94, 116, 122, 134, 135, 138, 139, 140, 141, 143, 144, 149, 150, 155, 157, 161

## T

temperature 21, 46, 51, 54, 56, 90, 91, 92, 98, 99, 105, 106, 107, 120, 121, 122, 123, 133, 153, 155, 161, 164, 165, 166

tensile strength 93, 94, 136

thermodynamics 37, 43, 90, 91, 92

thorium fuel cycle 168

tin whiskers vii, ix, 24, 72, 74, 77, 78, 79, 108, 120

traditional ceramics 113, 121, 122

transistors 33, 61, 97, 122, 138, 141, 142, 143, 146, 147, 149, 150, 151, 156

transition metals 105

## U

uranium 35, 36, 50, 53, 151, 159, 160, 167

uranium-235 36

uranium fuel cycle 159, 160

## V

vacancies 97, 111, 119, 120, 164

vacancy 119, 120

valence energy 37

valence orbital 37, 59, 126

Valence Shell Electron Pair Repulsion (VSEPR) 113, 170

van der Waals forces 117, 130

voids 154

voltage 46, 61, 95, 124, 125, 144, 146, 147, 148, 149

## W

Westinghouse Electric Corporation 159

